



HICHROM

Chromatography Columns and Supplies

INTERNATIONAL CATALOGUE 9



INTRODUCTION

Based in the UK and founded in 1978, Hichrom is dedicated to supplying the highest quality HPLC and UHPLC columns and other chromatography products to the scientific community. As a leading global LC column manufacturer, we have gained an unrivalled reputation for excellent quality, competitively priced products and fast delivery – all backed up with expert technical support and after-sales service. Our worldwide network of distributors currently supplies Hichrom columns to laboratories in over 100 countries.



In addition to our own manufactured products, Hichrom is a distributor for many of the major HPLC column suppliers, including Advanced Chromatography Technologies, Advanced Materials Technology, Akzo Nobel, CERI, Chiral Technologies, Dikma, Eprogen, ES Industries, GL Sciences, Grace, Macherey-Nagel, Merck Millipore, MicroSolv, Mitsubishi, Nacalai Tesque, Nomura, PolyLC, Princeton, Regis, RStech, Shinwa, Shodex, SIELC, Thermo Scientific, Tosoh Bioscience, Waters, YMC and ZirChrom.

We also supply an extensive range of SFC, GC, SPE, TLC, Flash, CE, LC-MS and GC-MS products. Our technical staff will be happy to respond to any customer enquiries - please see pages 6 to 9 for further details of Hichrom technical services.

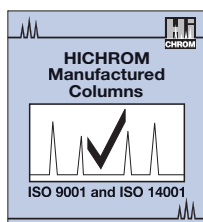

Hichrom Manufactured Columns - We guarantee that any HPLC or UHPLC column produced by Hichrom will be manufactured to the highest possible quality standards, using only the original manufacturers' silica material. Please contact us for details of Hichrom manufactured columns not found in this catalogue. Details of the original silica manufacturers can be found in the

appropriate material section. For further details of Hichrom's column packing and custom packing services, please see page 8.



Quality and Environmentally Assured - Hichrom aims to supply the highest quality products to the chromatography industry. We are an ISO 9001:2008 accredited company and have been accredited since 1994. We also aim to minimise the impact of our business on the environment. We are an ISO 14001:2004 accredited company and have been accredited since 1996.



Environmental Statement - This catalogue is printed on paper sourced from environmentally aware forest product companies, and the pulp used in the manufacture of the paper is sourced from responsible forest resources. The paper used in this catalogue is a certified FSC®

grade. The pre-press process is 100% digital, which means that no film or any of the associated chemicals are used. No optical brighteners are used on the paper. This catalogue is printed on chlorine-free paper. Please recycle this catalogue where possible.

Despatch - The majority of Hichrom manufactured columns are available on a 24 hour despatch basis. Other items may vary by supplier and product type, but we will always despatch goods in an efficient and timely manner. Goods can be despatched by express carrier (subject to geographical location). An additional delivery charge may apply

Prices and Terms - Every effort is made to keep prices stable, although, owing to our policy of continuous product development and the wide variety of products contained in this catalogue, we reserve the right to change prices and specifications without notice. Please contact Hichrom or our distributors for a current price on any item. Further details of Hichrom's Terms and Conditions of Sale can be found on page 228 of this catalogue.

Warranty - All Hichrom manufactured products are under warranty against defects in material or workmanship. We will promptly replace any such goods unless the defects are attributed to customer misuse.

Damaged and Returned Goods - Notification of goods damaged in transit or order discrepancies must be received in a timely manner. See Hichrom's Terms and Conditions of Sale on page 228. We will endeavour to assist with customer returns if possible but all returns are at Hichrom's sole discretion. A handling charge may be applicable. It is always important to contact us before sending any goods back. We will provide you with relevant returns information/numbers and, where appropriate, any decontamination certificates.

Contact Information

Please contact us if you have any questions about our products or services.

Tel: +44 (0) 118 930 3660

Fax: +44 (0) 118 932 3484

sales@hichrom.co.uk www.hichrom.co.uk

Hichrom Ltd, 1 The Markham Centre, Station Road, Theale, Reading, Berkshire, RG7 4PE, UK

Images, Copyright and Trademarks - The images in this publication, from copies held by Hichrom Limited, are used by kind permission of the owners of said images. Further distribution and/or any commercial use of the works contained within this publication is strictly forbidden without the permission of the copyright holder. Hichrom Limited acknowledges the registered and unregistered trademarks that appear in this catalogue. Please see page 220 for a listing of trademarks.

This catalogue is copyright © 2014 Hichrom Limited. All rights reserved.

NEW PRODUCTS	1-4
---------------------------	-----

MISSION STATEMENT	5
--------------------------------	---

HICHROM TECHNICAL SERVICES

Technical services	6-8
Technical seminars and workshops	9

LC COLUMN INFORMATION

Column evaluation	10
Analytical and medium bore columns	11
Microbore columns	12
Capillary and nano columns	13
LC-MS columns	14
UHPLC columns	15
Superficially porous columns	16
Method transfer from HPLC to UHPLC	17-19
Hichrom guard cartridges	20-21
Preparative and process scale columns	22-23
Buffer selection	24
Proteomics	25
Metabolomics	26
Supercritical Fluid Chromatography (SFC)	27
Capillary Electrophoresis (CE)	28

LC COLUMN SELECTION

Column selection overview	29
Reversed-phase column selectivity	30
Characterisation of C18 phases	31-32
Specifications of C18-bonded RP materials	33-34
Specifications of C1- to C8-bonded & C30 materials	35-36
Polar embedded and other 'AQ' type phases	37
Wide pore (300Å) RP phases	38
Hydrophobic Interaction Chromatography phases	39
Phenyl bonded phases	40
PFP bonded phases	41
Polar bonded phases	42-43
HILIC phases	44
Silica phases	45
Ion-exchange phases	46-47
Ion chromatography phases	48
Size exclusion chromatography phases	49
Affinity chromatography phases	50
Chiral phases	51-53
Column selection by USP specifications	54-57

LC COLUMNS

ACE and ACE Excel	58-73
Chiral Technologies	74-75
COSMOSIL	76-79

LC COLUMNS (continued)

Develosil.....	80-81
Dikma	82-83
Eprogen	84
ES Industries	85
Exsil	86
GL Sciences	87-89
Grace.....	90
HALO and HALO-5.....	91
Hichrom C8 and C18	92-96
Hichrom RPB	97-98
Hichrom PAH2	99
Hichrom chiral columns.....	100
L-column.....	101
Macherey-Nagel LC	102-106
MCI GEL.....	107-108
Merck Millipore	109-114
MicroSolv Cogent.....	115-120
Partisil and Partisphere	121-125
Perkin Elmer Brownlee	126
PolyLC.....	127-130
Princeton SFC and HPLC	131-135
Regis	136-137
Shodex.....	138-142
SIELC.....	143-148
Thermo Scientific LC	149-153
Tosoh Bioscience	154-155
Ultrasphere.....	156-157
Ultron Chiral	158
Wakopak Fluofix.....	159
Waters Spherisorb	160-161
ZirChrom.....	162-164
ZORBAX.....	165-166

GAS CHROMATOGRAPHY

USP Specifications GC phases	167
HiCap capillary GC columns.....	168-170
GC derivatization reagents	171
GC inlet supplies	172
Digital flowmeter.....	173
Gas leak detector.....	173
CE capillaries and accessories	174

SAMPLE PREPARATION

Solid Phase Extraction (SPE) overview	175
Smart Bag air sampling bags.....	176
Pipette/Syringe tips	177
Syringe filters.....	178
TLC plates.....	179-181

LC CONSUMABLES and ACCESSORIES

Reduced Surface Activity (RSA) Vials	182-184
Vials.....	185
Tubing.....	186-187
Fittings and connectors	188-191
Frits	192
Spanners.....	192
Filters.....	193-194
Rheodyne	195-202
HPLC detector lamps.....	203
Syringes.....	203
Smart Caps	204-205
DryLab	206-207
Books.....	208-210

APPENDICES

Glossary of HPLC terms.....	211-214
Chromatographic abbreviations.....	215
HPLC calculations	216
HPLC solvent properties	217
HPLC column cleaning procedures.....	218-219
Trademarks	220

INDEX.....	221-227
------------	---------

TERMS AND CONDITIONS	228
----------------------------	-----

NEW PRODUCTS

ACE® UltraCore™

- Ultra-inert solid-core UHPLC/HPLC columns
- 2.5 and 5µm particle sizes
- SuperC18™ and SuperPhenylHexyl™ phases
- Extended pH stability (1.5 – 11.0)

ACE® UltraCore™ is a new range of ultra-inert UHPLC/HPLC solid-core (superficially porous) 2.5 and 5µm particle columns from Advanced Chromatography Technologies Limited. The monodisperse particle distribution of these phases combines high efficiency and performance with a low column back pressure. ACE UltraCore is available with SuperC18™ and SuperPhenylHexyl™ bonding. Both phases feature proprietary Encapsulated Bonding Technology (EBT™), which results in excellent peak shape and phase stability across an extended pH range of 1.5 to 11.0. Encapsulated Bonding Technology dramatically increases the ligand coverage of the silica surface and effectively eliminates the effect of unbonded silanol groups. This higher ligand coverage results in improved inertness, chromatographic performance and stability. These phases enable selectivity to be exploited at low, intermediate and high pH for rapid, systematic method development, with all the efficiency, robustness and lower pressure attributes of solid-core columns.

Please contact Hichrom for ordering details of ACE UltraCore columns.

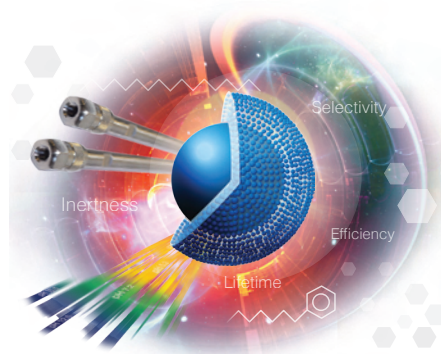

RAPID Sealing Products for 96 Well Plates

- Ideal for LC-MS applications
- Minimise sample contamination from adhesives
- Minimise needle blockage

Micro well plates are widely used in the pharmaceutical and biotech industries for storage, assays and analysis. Ideally, plates should be covered to prevent contamination, cross contamination between wells and solvent evaporation.

Bio Chromato, Inc of Japan manufactures the RAPID range of seals for 96 well plates. RAPID EPS and RAPID Slit Seals minimise problems of needle blockage and contamination from adhesives. Both seals are ideal for LC-MS applications and will maintain a seal even down to -80°C.

RAPID EPS (Easy Piercing Seal) seals are designed for sealing the surface of multiple well plates including 96, 384 and 1536 well plates, as they are available in sheet or roll format. The seal material is a polyolefin and uses synthetic rubber adhesive instead of silicon adhesive. No contamination of adhesive into samples occurs and no residual adhesive remains on the plates after removing the seals. A key feature of these seals is their high resistance to organic solvents such as methanol, acetonitrile and DMSO. RAPID EPS seals have an embossed surface for easy piercing.

The unique **RAPID Slit Seals** are designed for sealing the surface of 96 well plates. The seal material consists of a triple layer structure of PET film/silicon rubber/PET film. It is adhesive free on the well position to prevent needle blockage. The seals have a self closing function after piercing to minimise solvent evaporation, enabling multiple penetrations to be performed without damaging the sealing of the plate.

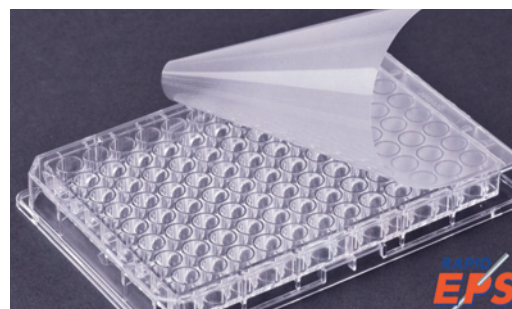

Rapid EPS

Product Specifications

	RAPID EPS	RAPID Slit Seal
Material	Polyolefin	Polyethylene, silicon adhesive
Applicable well plates	96, 384, 1536 well plate	96 well plate
Operating temperature	-80°C to 80°C	-80°C to 37°C
Organic solvent compatibility	Yes	No
Sterile condition	Not sterile	Not sterile
Genetic cleanliness	Not DNA free	Not DNA free

Please contact Hichrom for ordering details of RAPID sealing products.

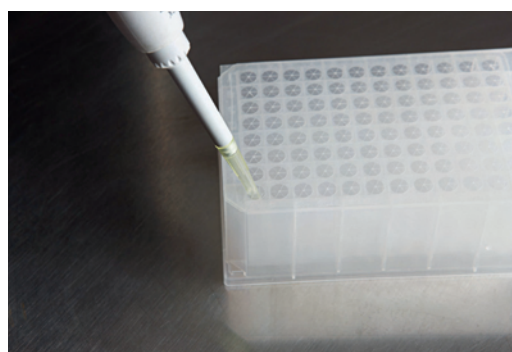

Rapid Slit Seal

MicroSolv Cogent UDA™

Cogent UDA™ is a new unique selectivity phase based on MicroSolv's TYPE-C Silica and silica hydride surface chemistry. This silica hydride surface is bonded with an eleven carbon chain terminating in a carboxylic acid (undecanoic acid), giving the phase weak cation-exchange properties in addition to aqueous normal-phase (ANP). All the features and benefits of TYPE-C Silica, such as fast equilibration, precision, multi-mode and robust column-lifetime are maintained. The Cogent UDA columns have applications in metabolomics and have been used for the analysis of nucleotides. The figure below shows the separation of energy adenine nucleotides on a Cogent UDA column. These three nucleotides are separated in order of increasing polarity, as expected when ANP chromatography is used.

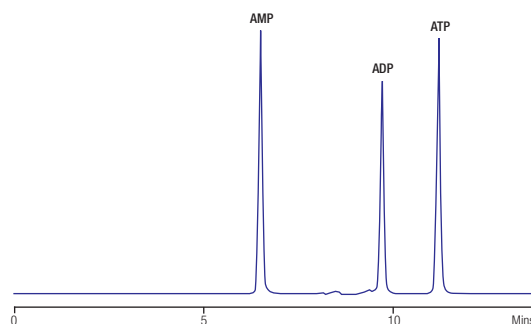

Column: Cogent UDA (4µm, 50 x 2.1 mm)
 Eluent: A: 16mM ammonium acetate in H₂O
 B: CH₃CN – 16mM ammonium acetate in H₂O
 Gradient: Time (mins) %B
 0 95
 0.5 95
 10 70
 15 30
 20 30
 20.1 95
 Flow rate: 0.4ml/min
 Temperature: 25°C
 Detection: UV, 254nm

Please contact Hichrom for ordering details of Cogent UDA columns.

RStech Corporation Products

RStech Corporation of Korea manufactures the OPTIMAPAK® and HECTOR ranges of HPLC columns and the INOPAK range of SPE columns. OPTIMAPAK columns are available in C18, C8, NH₂ and Silica chemistries. The newer HECTOR HPLC column ranges include several series of bonded phases, offering the customer a wide choice of selectivities.

HECTOR columns are designed for HPLC, LC-MS, SFC and SMB. All phases have low levels of metal impurities and are endcapped for reproducibility and durability. Columns are available packed with 3, 5 and 10µm particles and with microbore to preparative dimensions. HECTOR columns are suitable for a variety of applications in the pharmaceutical, chemical, environmental and food separation areas.

The **HECTOR** product line-up includes five different ranges:

HECTOR-M phases (100Å) are monomerically bonded and available with C18, C8, C4, NH₂, Diol, CN, Phenyl and Sil chemistries.

HECTOR-A C18 and C8 phases (100Å) contain a hydrophilic functional group, enabling them to be compatible with highly aqueous eluents and provide additional retention for polar compounds.

HECTOR-T has trifunctional C18 bonding (100Å), which confers a higher acid and base durability than monofunctional C18 phases.

HECTOR-W is a 300Å wide-pore silica available with C18, C8, C4 and NH₂ bonding, for the separation of peptides, proteins and oligonucleotides.

HECTOR-ACD ion-exchange phases (WCX and SCX) are specifically designed for the separation of acidic compounds.

INOPAK SPE columns have a wide range of applications, each showing high selectivity and enhanced recovery. They offer reproducible results and the potential for automation. INOPAK sorbents include C18, C8, NH₂, Silica and Florisil packed in 1, 3 and 6ml syringes.

Please contact Hichrom for ordering details of any RStech product.



Coresep™ Mixed-mode Core-Shell Columns

- Silica based core-shell phases with mixed-mode bonding
- 2.7µm particles with 90Å pore size
- LC-MS compatible eluents
- 3 bonded phases

SIELC Technologies has developed Coresep™, a new generation of unique stationary phases which combine mixed-mode bonding and core-shell technologies. Three different bonded phases have been developed, based on the mixed-mode bonding technology of the established Primesep and Obelisc ranges. Mixed-mode columns offer higher capacity and retention than traditional reversed-phase columns. Since the surface area of core-shell particles is reduced, mixed-mode phases address potential loadability issues whilst maintaining the selectivity advantages of multiple interactions. Optimised ligand density and ionic/hydrophobic ratios further increase the capacity of mixed-mode core-shell columns.

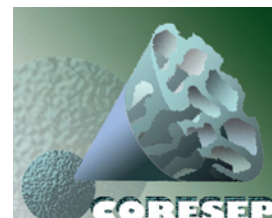

Coresep 100 is a reversed-phase core-shell phase with embedded acidic ion-pairing groups. It can show an improved retention of basic compounds by a cation-exchange mechanism. In addition, it can separate acids by ion-exclusion. Figure 1 shows the separation of a mixture of 7 hydrophilic and ionic compounds on Coresep 100. All compounds have low hydrophobicity, and adequate retention on a reversed-phase column is difficult to achieve. Using the reversed-phase and ion-exchange mechanisms of Coresep 100, retention and complete separation of all components was achieved within 5 minutes.

Coresep S is a normal-phase core-shell material with embedded acidic ion-pairing groups. It is particularly suitable for separation of common sugars and other neutral or very polar molecules. Weak bases can be separated by an ion-exchange mechanism, whilst acids are separated by ion-exclusion.

Coresep SB is a reversed-phase core-shell material with embedded strong basic ion-pairing groups. It shows improved retention of acidic compounds by an anion-exchange mechanism and separates bases by ion-exclusion.

Please contact Hichrom for ordering details of Coresep columns.

Column: Coresep 100 (2.7µm, 50 x 3.2mm)
 Eluent: A: 30mM amm formate, pH 3.5 – CH₃CN (90:10)
 B: 70mM amm formate, pH 3.5 – CH₃CN (35:65)
 Gradient: 100% A to 100% B over 5 mins
 Flow rate: 1.2ml/min
 Detection: UV, 270nm

1. Adenosine
2. 3,4-Difluoroaniline
3. 4-Amino-2-chloropyridine
4. 4-Amino-3-chloropyridine
5. 5-Aminoindole
6. 2-Amino-5-methylthiadiazole
7. 4-Ethylaniline

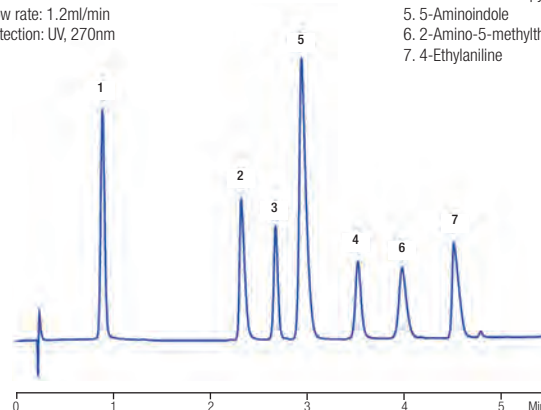

Figure 1. Separation of mixture on Coresep 100

MCI GEL™ Mixed-mode Column

MCI GEL™ CHK40/C04 is a new mixed-mode column manufactured by Mitsubishi Chemical Corporation. This is a low capacity cation-exchange resin based on 4µm particle size sulphonated poly(ethylstyrene-divinylbenzene) copolymer, with separations based on both hydrophobic and hydrophilic interactions. Mitsubishi Chemical Corporation have found that the column gives high performance for polar compounds, including amino acids, nucleic acids and small peptides.

Please contact Hichrom for ordering details of MCI GEL mixed-mode columns.

COSMOSIL® PFP and PBr HPLC Columns

Nacalai Tesque have launched COSMOSIL® 5PFP, a pentafluorophenyl-bonded HPLC column with alternative selectivity to C18 columns. In addition to a hydrophobic separation mechanism, the phase offers dipole-dipole and π - π interactions. COSMOSIL 5PFP shows good retention for compounds with strong dipole moments, such as cationic or halogenated compounds, and exhibits high steric selectivity for structural isomer separations. Columns with analytical to preparative dimensions are available.

The new COSMOSIL PBr column is a pentabromobenzyl bonded phase designed for the reversed-phase separation of polar compounds that may not require HILIC separation conditions. Separations are achieved using a combination of hydrophobic and dispersion forces.

Please contact Hichrom for ordering details of COSMOSIL PFP and PBr columns.



MicroSolv Cogent Diol™

Cogent Diol™ is the latest addition to the MicroSolv TYPE-C Silica™ range of stationary phases. This 4 μ m diol bonded phase is suitable for the reversed-phase or aqueous normal-phase (ANP) analysis of polar compounds and is LC-MS compatible. Columns show fast equilibration between gradient runs and can be successfully used in studies of pathways in human pathology. The figure below shows the LC-MS separation of uric acid metabolites in human urine. Allantoin and 6-aminouracil are used as biomarkers for different disease states. Their peaks are well separated and the use of formic acid in the eluent ensures good MS sensitivity.

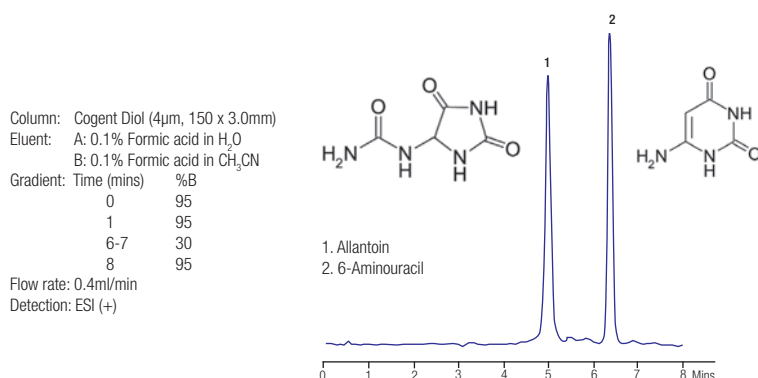

Please contact Hichrom for ordering details of MicroSolv Cogent Diol columns.

MISSION STATEMENT

Hichrom aims to supply the highest quality HPLC columns and consumable products to the chromatography industry. We measure the quality of our service not only in the product itself but in the nature of our technical consultancy and after-sales service. In doing so we aspire to achieve complete customer satisfaction and make an important contribution to the future of the life sciences and related chemical industries.

Quality and Traceability – ISO 9001:2008

We believe that quality assurance is fundamental to our operations at every level, and in 1994 we gained official recognition with the award of ISO 9001 accreditation. Every Hichrom manufactured column is supplied with documentation which enables a full audit trail to be performed from the point of manufacture to the time of use.

Environmental Awareness – ISO 14001:2004

Hichrom also places a great emphasis on environmental awareness, and in 1996 became the first chromatography company to receive approval of an ISO 14001 Environmental Management System. In doing so it adheres to the Control of Substances Hazardous to Health regulations (1998), its amendments and other related legislation.

Column Sales Policy

We offer very high performance, competitively priced, pre-packed liquid chromatography columns of guaranteed efficiency. Every column is individually tested prior to despatch and only those which meet Hichrom's strict specifications are accepted. To maintain this high quality we utilise only selected batches of raw materials. We guarantee to replace any column which does not give full customer satisfaction.

Column Despatch

The majority of columns are available on a 24-hour despatch basis. Columns of non-standard dimensions, columns packed with alternative material or those for use with specific instrumentation can be supplied on request. Telephone, fax or email orders are welcome.

Column Reproducibility

By purchasing raw materials in as large a batch size as possible and checking selectivity where appropriate, Hichrom endeavours to minimise batch-to-batch variation. We are also happy to supply columns from customer specified batches of packing material.

Column Durability

Each type of column we manufacture has been tested for durability over a 48-hour period. After initial evaluation, a typical eluent is passed through the column for a 48-hour period and its performance re-measured. A column is only considered satisfactory if it maintains its original performance.

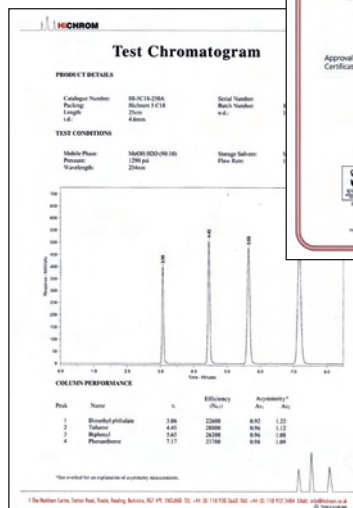

Column Supply and Sourcing Solutions

Hichrom Limited offers a complete column sourcing solution for any laboratory. We supply many of the world's leading column brands and work closely with the key manufacturers. Additionally, we have excellent relationships with a wide number of the less well known column producers and are experts at sourcing some of the more 'obscure' column brands from all over the globe. Furthermore, if your specific column requirement is no longer available, for whatever reason, we will be happy to recommend a suitable alternative to meet your needs.



Column Lifetime Advice

Column lifetime is an important factor for any analyst and it pays to make sure that you are getting the longest possible lifetime for your column and application. No column lasts forever but the additional cost and inconvenience of replacing a column too frequently is something to be avoided. The quality and aqueous stability of HPLC silicas have improved over time. However, the inherent chemical instability of bonded phases at low pH and the dissolution of silicas at high pH, remains an underlying problem for all chromatographers. Hichrom offers advice and support on all column lifetime issues, including the use of modified silica technologies, column protection, column storage and column usage conditions.

Troubleshooting Support

Hichrom's expert Technical Support team are available to provide useful advice and support on any HPLC/UHPLC troubleshooting issue. Whether you have questions or problems with method reproducibility, impurity peaks, sample cleanliness, method transfer, scale-up or any other area of chromatography, our experts are available by phone or email with a quick and helpful response.



Column Selection Guidance

There are numerous HPLC silica based column ranges and phases available for today's chromatographer to select from. The options are further increased when alternative base materials (polymer, titania, zirconia, graphite etc.) and technologies (UHPLC, superficially porous, hybrid, monolithic, Type-C, mixed-mode etc.) are considered. Hichrom scientists are familiar with the huge range of column brands and technologies available and are able to provide informed advice on the best column choices for your methods. We maintain a comprehensive library of general and manufacturers' literature, both current and historic. Our practical experience in manufacturing and evaluating our own columns, together with those of many other manufacturers, ensures that we always have extensive and up-to-date experience of column selection. Simply contact our technical group for valuable, time-saving, free of charge advice.

SFC, GC, SPE, TLC, Flash, CE, LC-MS, GC-MS and New Developments

Hichrom offers free technical support and advice in all other areas of chromatography including SFC, GC, SPE and other sample preparation techniques (eg. SLE, MMSE, pipette tips), as well as TLC, flash chromatography, capillary electrophoresis and hyphenated techniques such as GC-MS, LC-MS and LC-MS/MS. We are also well placed to keep you up to date with the latest developments in the industry, whether that's a new technique or a new product.



For professional technical advice and assistance:

Tel: +44 (0) 118 930 3660 Fax: +44 (0) 118 932 3484
 Email: technical@hichrom.co.uk www.hichrom.co.uk

Hichrom Limited, 1 The Markham Centre, Station Road,
 Theale, Reading, Berkshire, RG7 4PE, United Kingdom

Application Support

Hichrom has an extensive in-house reference database of HPLC and UHPLC applications, covering a large number of analytes, separated on a wide range of column materials. This database includes applications related to chiral analyses. We also have access to a vast number of additional applications and method recommendations through our extensive supplier and partner network. In addition to HPLC and UHPLC applications, we also offer application support on SFC (both chiral and achiral), as well as GC, CE and SPE methods.

Applications cover a broad range of interest areas including biochemical, food, ion analysis, organics, environmental, pharmaceutical and polymers to name a few. Searches can be performed on individual compounds, a mixture of components or a specific column. With this resource we are able to offer useful advice and information to aid you in the selection of a suitable column, or for identifying a suitable alternative column, for any given assay.



Method Development and Optimisation Strategy

With our extensive experience of columns, column technologies and HPLC methods, and utilising resources such as our applications database, Hichrom technical staff are able to discuss your method requirements with you, to offer useful advice and direction for your specific assay. This includes suggesting appropriate method development strategies, suitable LC conditions (including buffer, pH and temperature), column types and specifications, starting points, robustness concerns and resolution criteria. If you are looking to speed up your method, or convert from HPLC to UHPLC or superficially porous technology, we can provide useful information on how best to do this and the pitfalls to avoid. If you have an existing method but need to further optimise it, our experts will be able to offer you the support and assistance you need.

DryLab Computer Aided Method Development

Hichrom offers the DryLab computer aided method development software, which enables you to develop better, more robust HPLC/UHPLC methods, faster and more efficiently. It also allows you to optimise or modify existing HPLC methods for successful transfer to alternative UHPLC/HPLC equipment. DryLab is so powerful, that from just 12 practical runs in the laboratory, you can model up to 1,000,000 possible chromatographic solutions, saving you a huge amount of time and money. A new robustness module additionally allows you to simply and quickly explore the boundaries of robustness, cumulatively or independently, for all specified parameters. Please see page 206 for additional details or contact us to discuss DryLab method development software further.

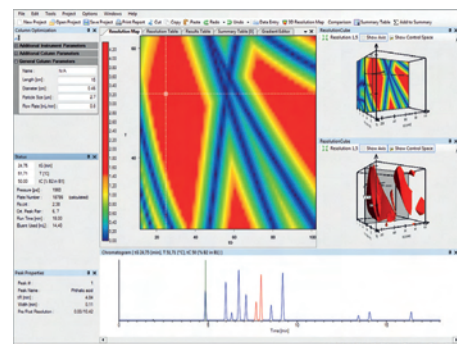

Column Screening Services

As the availability of HPLC silicas and phases increases, selection of the optimum column for a particular assay is becoming an increasingly difficult and time consuming task. Hichrom maintains an extensive HPLC column library and has valuable expertise in the area of column screening and column comparisons. As such we are well placed to advise you on the selection of the optimum phase for your assay.

Working with our partners we also offer a number of column screening options (both chiral and achiral), where your sample can be run on a number of different column options in order to establish the ideal column for the specific application. Confidentiality is guaranteed and confidentiality agreements are offered to support this.

For application and method development support:

Tel: +44 (0) 118 930 3660 Fax: +44 (0) 118 932 3484
Email: technical@hichrom.co.uk www.hichrom.co.uk

Hichrom Limited, 1 The Markham Centre, Station Road,
Theale, Reading, Berkshire, RG7 4PE, United Kingdom

Extensive Range of Dimensions and Silicas

Based in the UK, Hichrom is a leading global manufacturer of HPLC and UHPLC columns. We offer unrivalled experience in the manufacture of superior quality HPLC columns, in an extensive range of dimensions from capillary to preparative. We are also able to pack columns from any commercially available material. If you cannot find the column dimensions/silica you require in this catalogue, please contact our technical team who will be happy to check availability and discuss the option of a custom manufactured column. We are highly experienced in the manufacture of unique dimension/silica columns for specific applications and are able to offer many products that are not listed in this catalogue.

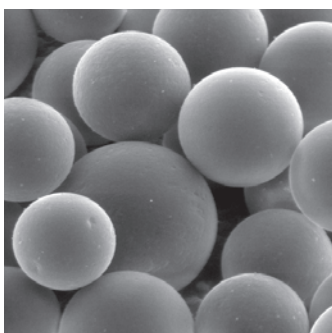

Customer Supplied Packings

In addition to the wide range of materials listed in this catalogue, Hichrom can also manufacture columns from any commercially available material and pack columns from customer supplied materials. Please contact us to discuss this service. We will be pleased to sign a confidentiality agreement if required.

Batch Reservation Service

Hichrom recognises that column-to-column reproducibility is of the utmost importance and all Hichrom columns are manufactured to very stringent quality specifications. Additionally, column manufacture is optimised on the largest batch size of silica available. However, for particularly searching applications, Hichrom also offers a no charge batch reservation service which completely eliminates any batch related reproducibility concerns. Based on your projected column usage (large or small), Hichrom will reserve the quantity of silica you require and pack columns from this material as and when you require them.

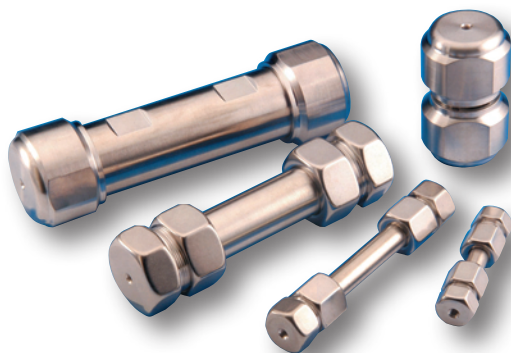

For details of our column packing service:

Tel: +44 (0) 118 930 3660 Fax: +44 (0) 118 932 3484
Email: technical@hichrom.co.uk www.hichrom.co.uk

Hichrom Limited, 1 The Markham Centre, Station Road,
Theale, Reading, Berkshire, RG7 4PE, United Kingdom



John Dolan



Mel Euerby

Keep Up-to-Date with the Latest Developments

Our experts are at the forefront of developments in the chromatography industry and will always ensure that the very latest information is available to you. We specialise in providing scientists with the chromatography skills and knowledge they need to make efficiency gains and productivity improvements in the laboratory. Whether you are a relative newcomer to HPLC or a seasoned veteran, you can benefit from one of our courses.

Full Day and Short 1-2 Hour Chromatography Courses

Hichrom offers a wide range of chromatography courses to suit everyone's needs and budgets. Full one and two day courses provide the ideal environment for those who need to develop a thorough understanding of a topic in as short a time as possible. Shorter 1-2 hour seminars are ideal learning experiences for busy chromatographers who simply want to brush up on their skills or to develop experience in a new field or topic.

Cost Effective

We are confident that the techniques you will hear about on our courses will provide you with many ideas for improving efficiency in the laboratory – in fact we guarantee it! If after six months you have not been able to recover the registration fees by applying what you have learnt from the course, we will happily refund your money.

IBMS CPD Accreditation, RSC and ChromSoc Members

All our listed courses are IBMS CPD accredited and certificates will be issued to delegates on request. Additionally IBMS, RSC and ChromSoc members all receive preferential rates on our courses.

Request a copy of our latest HPLC Workshops Training Book

For full details of all our courses simply request a copy of our latest HPLC Workshops Training Book at seminars@hichrom.co.uk.

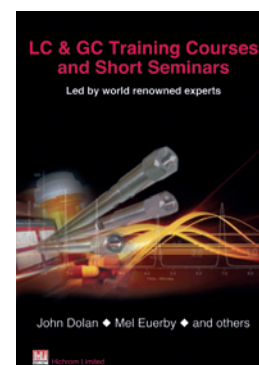

Full day courses include:

- An Introduction to HPLC
- Stepwise Introduction to 'Practical' HPLC
- HPLC and UHPLC Troubleshooting
- Making HPLC Methods Work
- Transferring HPLC Methods to UHPLC
- HPLC Method Development
- Advanced HPLC Method Development
- Validating HPLC Methods
- LC-MS for Chromatographers
- Big Molecules – Big Challenges
- Advances in Chiral Analysis
- An Introduction to Gas Chromatography
- GC Troubleshooting
- GC Method Development

Short courses include:

- Basic Concepts in HPLC
- HPLC Instrument Basics
- HPLC & UHPLC Column Care and Maintenance
- Exploiting Selectivity in HPLC and UHPLC
- Exploring the Power of Eluent pH in LC
- The Analysis of Polar Molecules
- Practical Chiral Chromatography
- Techniques for Biomolecule Characterisation
- Practical SFC
- Superficially Porous Phases
- The Technique of GC in 3 Parts
- Essential SEC
- Essential HILIC

For further information on any of our courses:

Tel: +44 (0) 118 930 3660 Fax: +44 (0) 118 932 3484
 Email: seminars@hichrom.co.uk www.hichrom.co.uk

Hichrom Limited, 1 The Markham Centre, Station Road,
 Theale, Reading, Berkshire, RG7 4PE, United Kingdom

Hichrom columns are rigorously tested prior to sale. Every column is supplied with a unique chromatogram corresponding to the column purchased (Figure 1). Efficiency measurements and two peak asymmetry calculations are recorded for each component of the quality control test mixture.

Details of the Hichrom quality control test mixtures are available on request. Information regarding the care and use of Hichrom columns is displayed on the reverse of every chromatogram.

It is recommended that the performance of a column is tested on arrival and periodically during use. A column performance history enables the chromatographer to readily decide the most suitable time for column replacement or regeneration. Performance parameters are as defined below.

The peak asymmetry factor determined by ratioing plate efficiencies at 10% and 50% peak height is more sensitive to 'tailing' and 'fronting' effects than the conventional method using peak half-width ratios and therefore a better test of column performance.

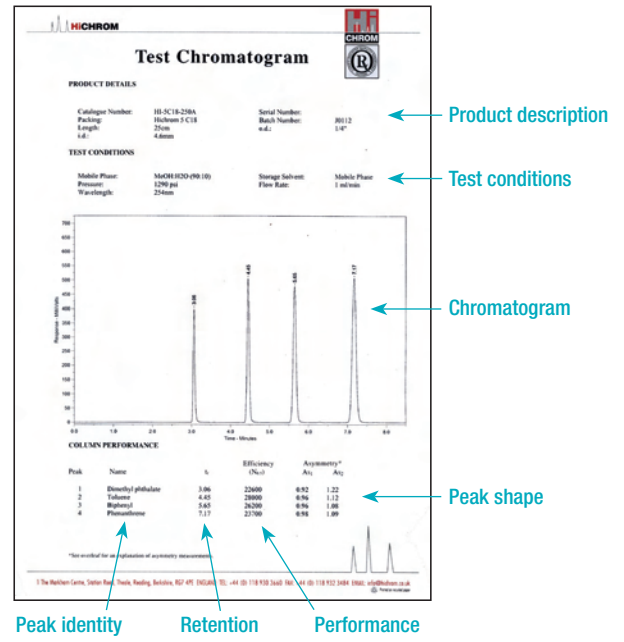
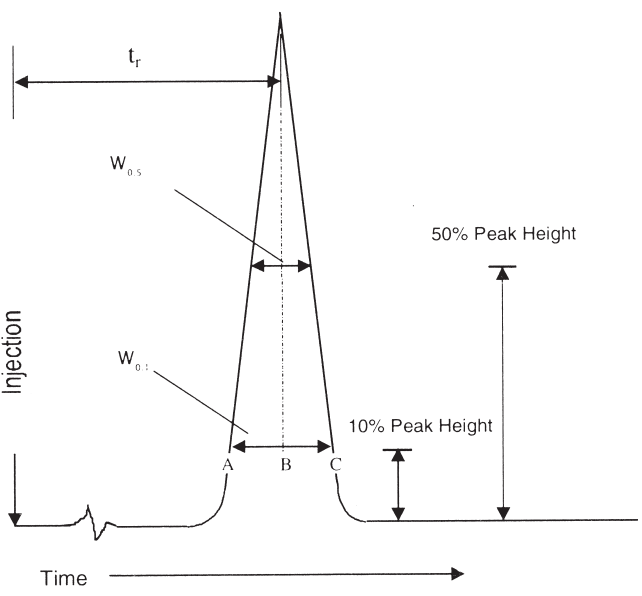

Figure 1. Test chromatogram

Asymmetry and Efficiency Measurements



Hichrom use two asymmetry factors based on the ratios:-

$$As_1 = \frac{N_{0.1}}{N_{0.5}} \quad \text{and} \quad As_2 = \frac{BC}{AB}$$

using the efficiencies,

$$N_{0.1} = 18.55 \left(\frac{t_r}{W_{0.1}} \right)^2 \quad \text{and} \quad N_{0.5} = 5.54 \left(\frac{t_r}{W_{0.5}} \right)^2$$

where

- $N_{0.1}$ = Efficiency measured at 10% of peak height
- $N_{0.5}$ = Efficiency measured at 50% of peak height

As_1 is more sensitive to the negative effects of tailing and fronting than the conventional measurement As_2 .

For an ideal Gaussian peak As_1 will be 1.00.

As_2 indicates relative 'fronting' & 'tailing'.

- $As_2 = 1.00$ for symmetrical peaks
- $As_2 < 1.00$ indicates fronting peak
- $As_2 > 1.00$ indicates tailing peak.

Traditionally, columns of either 4.6 or 4.0mm i.d. and 150 or 250mm length have been used as the industry's standard for analytical applications. Such columns are still the most popular, although there is an on-going transition to shorter and narrower i.d. columns. The increased application of hyphenated techniques, such as LC-MS and LC-MS/MS, capable of providing analyte characterisation data, has necessitated the use of lower solvent volumes and hence smaller columns. Increased assay sensitivity and decreased sample requirements have also led to the use of smaller i.d. columns, including 3.2mm i.d. medium bore columns.

Silica

Silica is the most popular base material for HPLC phases. Despite its necessary porosity, it has a high physical strength and a surface to which a broad range of ligands can be attached using well established silanisation technology. The majority of separations are performed using these bonded materials under reversed-phase conditions.

Spherical silica particles are easier to pack than irregular particles and enable high performance, stable and low back pressure columns to be reproducibly obtained.

Performance

The efficiency of a column depends on the choice of particle size and column length. The mode and quality of manufacture will also affect its performance. Particle size refers to the average diameter of the spherical silica particle. Commonly used silicas have a distribution of diameters; hence a material of nominal particle size 5µm can typically contain silica particles between 4.0 and 6.5µm diameter (Figure 1).

Smaller particles give higher efficiencies for constant column length, but also give higher column back pressure, resulting in an effective maximum column length when used with conventional HPLC systems.

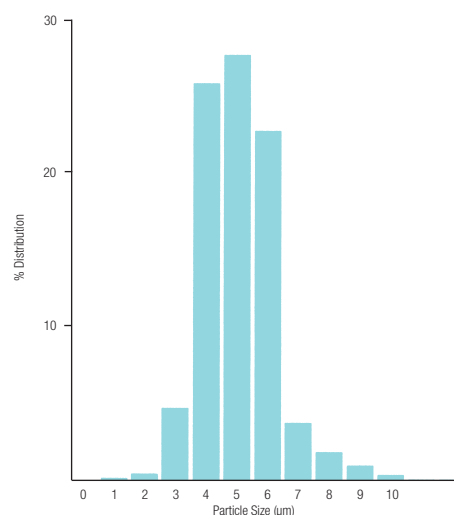

Figure 1. Typical silica particle size distribution

Silica Phases

Silica Particle Size ¹ (µm)	Maximum Recommended Column Length (mm)	Plate Efficiency (plates/metre)	Use of Columns
3	150	120-200,000	Fast analysis without loss of efficiency or sacrificing column life
5	250	80-120,000	Routine analysis requiring a high separation performance under moderate operating pressure
10	>250	40-60,000	Moderate efficiency at low operating pressures. Routine QC labs or as scout column for scaling-up methods
>10	>250	<40,000	Primarily for preparative applications

¹ For ≤2µm UHPLC columns, please see page 15

Medium Bore Columns

For analysts who do not have access to more modern, low dispersion volume HPLC equipment, intermediate i.d. medium bore columns (3.2mm i.d.) represent a compromise between using standard 4.6mm i.d. columns and microbore columns of 2.1mm i.d. or less.

Medium bore columns offer a 50% saving in solvent consumption for the same linear dynamic flow without necessarily requiring a change to lower dispersion volume injectors and flow cells. This reduces costs and environmental issues associated with solvent disposal. In practice chromatograms obtained from 3.2 and 4.6mm i.d. columns with the same linear dynamic flow are very similar (Figure 2). For satisfactory use of 2.1mm or lower i.d. columns, systems need to be adjusted for system dead volume (see page 12).

A flow rate of 0.76ml/min through a 4.0mm i.d. and 0.48ml/min through a 3.2mm i.d. column gives the same relative flow rate as 1ml/min through a 4.6mm i.d. column.

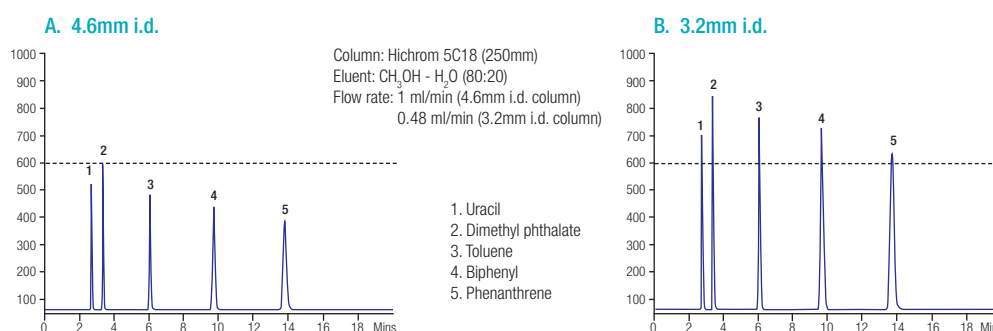

Figure 2. Comparison between 4.6mm and 3.2mm i.d. columns

- Solvent consumption reduced by 80-95%
- Sensitivity increased x5 to x21
- Significant cost-saving
- LC-MS applications

Microbore columns (1.0 and 2.1mm i.d.) offer significant theoretical advantages over conventional 4.6mm i.d. analytical columns. Hichrom currently offer a comprehensive range of 1.0 and 2.1mm i.d. microbore columns, which offer minimal loss in performance compared to the corresponding analytical columns and can be used with optimised conventional equipment.

Comparison of Microbore and Standard Column Parameters

i.d. (mm)	Column ¹ Internal Volume (µl)	Relative Flow Rate (ml/min)	Solvent Reduction (%)	Theoretical Sensitivity Increase	Recommended Flow Cell (µl)	Recommended Injection Volume (µl)
4.6	1500	1.0	-	-	8.0	20
4.0	1133	0.76	24	1.3	8.0	15
3.2	725	0.48	52	2	2.0-8.0	10
2.1	300	0.20	80	5	1.0-2.0	5
1.0	71	0.047	95	21	≤1.0	1

¹ 150mm length

Column Evaluation

For optimum performance of microbore columns, HPLC system dead volume must be minimised. If the calculated theoretical plate value is less than 90% of that measured by the manufacturer, there is probably an excessive amount of extra column volume in the system for the column being used. Early eluting peaks are less diluted and have smaller volumes than later eluting peaks and will consequently be more susceptible to the detrimental effects of excessive extra column volume.

Several measures can be undertaken to minimise the effect of extra column volume.

- Use connecting tubing that has an internal diameter of 0.010" (0.254mm) or less. Tubing with an i.d. of 0.007" (0.177mm) or lower is preferable for use with microbore columns (see Table 1).
- Keep the connecting tubing as short as possible between the injector and the column, and the column and the detector. For microbore columns, it is desirable to keep these distances less than 5cm.
- Use only 'low dead volume' fittings and unions. A fingertight column coupler (throughbore 0.007") HI-081 is recommended to connect guard and microbore columns (see page 20).
- Use a low volume (microflow) detector flow cell (≤2.0µl).

Table 1. Connection Tubing Internal Volumes

Tubing i.d. (inches)	Volume per 5m length (µl)
0.006 (0.152mm)	0.9
0.010 (0.254mm)	2.5
0.020 (0.508mm)	10.1
0.030 (0.762mm)	22.8

Figure 1 illustrates what can happen when a microbore column is used with a typical HPLC system. The microbore column (B) is unable to achieve the baseline separation provided by the 4.6mm i.d. column (A), unless the HPLC system is 'optimised' (C). In the latter case, the optimised system has less than 10µl of extra column volume, so excellent resolution and peak shape can be obtained.

A. Typical HPLC System
Standard Bore Column, 150 x 4.6mm

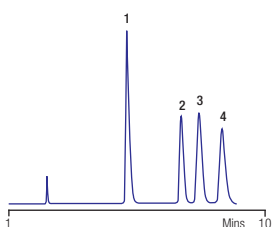

B. Typical HPLC System
Microbore Column, 150 x 2.1mm

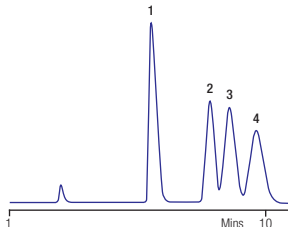

C. Optimised HPLC System
Microbore Column, 150 x 2.1mm

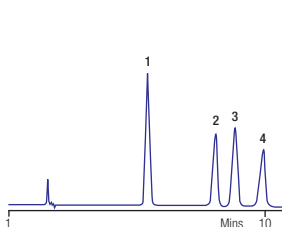

Eluent: 0.025M KH₂PO₄ + 0.2% TFA + 0.2% TEA, pH 2.5 - CH₃CN (64:36)
Flow rate: 1 ml/min for 150 x 4.6mm column
0.2 ml/min for 150 x 2.1mm column
Sample: Tricyclic antidepressants

1. Doxepin
2. Nortriptyline
3. Amitriptyline
4. Trimipramine

Figure 1. HPLC systems must be optimised to obtain the best performance from microbore columns

- High sensitivity
- Low sample mass and volume applications
- LC-MS and LC-MS/MS applications
- Very low solvent consumption

Capillary and nano HPLC are gaining acceptance in applications where limited sample amounts lead to problems in detection sensitivity. High sensitivity and high resolution separations can now be achieved for small sample volumes. This is relevant in the areas of pharmacokinetics, trace analysis and particularly the rapidly expanding field of bioanalytical and proteomic analysis. Figure 1 shows the analysis of a protein mixture digest on a nano column.

Capillary and nano columns are ideal for use with detectors requiring the lowest flow rates, such as the electrospray LC-MS detector. Indeed, the on-line coupling with a mass spectrometer has been a major driving force behind the development of capillary chromatography.

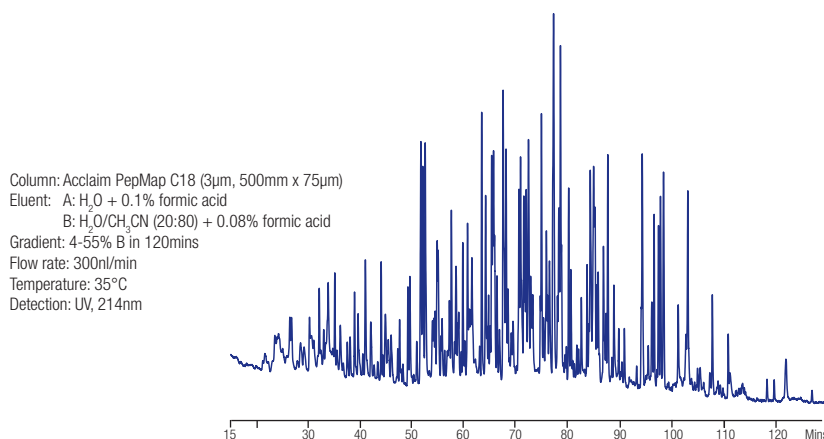

Figure 1. Protein mixture digest

Sensitivity

The introduction of capillary and nano columns has made possible high sensitivity and high resolution separations for small sample volumes. Table 1 shows the theoretical sensitivity increase of various i.d. capillary columns compared with a 1mm i.d. microbore column. The use of a 0.075mm (75µm) i.d. column, in theory, can decrease detection limits by a factor of >3500 relative to a 4.6mm i.d. column when the same sample size is used, due to lower chromatographic dilution of the sample.

Table 1.

Column i.d. (mm)	Typical Flow Rate (µl/min)	Theoretical Sensitivity Increase
1.0	40 - 240	-
0.5	10 - 60	4
0.3	3 - 18	11
0.15	0.05 - 5	44
0.075	0.02 - 1.5	178

Instrument Modifications

In order to fully exploit the benefits of using capillary dimensions, the HPLC system must be capable of handling sample volumes in the sub-microlitre range. The use of columns of <1mm i.d. requires either a specially designed micro-LC instrument or extensive modifications of a standard HPLC instrument. The major principles in the conversion are flow rate reduction and elimination of dead volume.

Flow rate reduction can be achieved using a high performance, low µl/minute pump or by incorporating a flow splitting tee between a standard HPLC pump and the injector. The majority of the flow can be spilt to waste or recycled.

To ensure that band spreading is kept to a minimum, low dispersion column hardware must be used throughout the system. Connecting capillaries must be dead volume free and as short as possible. A micro-scale injector allowing injection of sub-microlitre sample volumes should be used. Micro flow cells with appropriate internal volume (<1µl) and path length should be used for UV detection.

Column Availability

Capillary and nano columns, ranging in i.d. from 0.05mm to 0.8mm, are available in several manufacturers' ranges – please contact Hichrom for further information.

Trap Columns

Short capillary or nano dimension columns are typically used for on-line preconcentration or desalting of protein and peptide samples prior to HPLC separation with MS detection. This enables fast clean-up of large volume injections. Typical trap column dimensions are 10 or 20mm length and 75 to 500µm i.d. Trap columns can be applied for 1D or 2D HPLC approaches. Please enquire for availability of trap columns.

- Column diameter ≤ 2.1 mm
- Rapid analysis
- Characterisation technique
- High sensitivity
- Quantitative analysis
- Peak deconvolution ability

Introduction

LC-MS is a leading technique which combines the separation capabilities of HPLC with the mass analysis capabilities of mass spectrometry. LC-MS is used for many applications, providing high sensitivity and high selectivity for small sample quantities. Liquid chromatography-tandem mass spectrometry (LC-MS/MS) combines high detection sensitivity with high analyte specificity.

Column Dimensions

LC-MS interface techniques such as Atmospheric Pressure Chemical Ionisation (APCI), Electrospray (ESI), Particle Beam or ThermoSpray can typically handle maximum flow rates of 200 μ l/min. As microbore columns (e.g. 2.1 mm i.d.) utilise such flow rates, they are commonly used in LC-MS applications. A 50 x 2.1 mm i.d. column is used for fast speed analysis applications, whilst a 250 x 2.1 mm i.d. column is preferred for more complex separations. When larger bore columns (3.0-4.6 mm i.d.) are used, a flow splitter is used to reduce the eluent flow into the mass spectrometer. Capillary columns (see page 13) are frequently used for proteomics applications, where sample quantities are limited.

Column Availability and Eluent Conditions

Eluents used for LC-MS must be volatile and preferably non-ion pairing. Suitable buffers include formate and acetate, while phosphate buffers must be avoided. Although there are limitations to eluent conditions, selectivity can be adjusted by changing bonded phase chemistry.

Many high purity silica materials, with low column bleed and high reproducibility, are now available for LC-MS. Generally, bonding chemistries which offer low bleed (e.g. C18, C8) are preferred over traditional PFP and polar embedded phases. However, the advent of newer bonding technologies has led to columns with alternative selectivity to C18, but which retain exceptionally low bleed characteristics.

Many methods which have a low requirement for buffer salts or modifiers are directly adaptable for LC-MS. For LC-MS and LC-MS/MS analyses, fully porous, superficially porous and monolithic reversed-phase columns are all used, as well as HILIC phases. Many suitable columns are discussed in later sections of this catalogue. Please contact us for further information and advice.

Applications

LC-MS and LC-MS/MS have numerous applications in a wide range of areas. These include:

- Drug metabolism structure elucidation and quantitative studies
- Clinical assays e.g. steroids, biogenic amines, vitamin D
- Protein and peptide identification and sequencing in proteomics studies
- Agrochemical identification and quantitative studies
- Food and beverage products e.g. additives and contaminants
- Forensic science e.g. drugs of abuse

Preparative LC-MS can also be used for fast and mass directed compound purification.

Figure 1 shows the use of single-ion monitoring in the analysis of a mixture of protease inhibitors. The base peak chromatogram is shown in (A), with the single-ion monitoring traces of each individual component shown in chromatograms (B) to (G).

Column: Hypersil GOLD aQ (1.9 μ m, 50 x 2.1 mm)
 Eluent: A: H₂O + 0.1% formic acid
 B: CH₃CN + 0.1% formic acid
 Gradient: 0 – 2.2 mins at 35% B then 100% at 4 mins
 Flow rate: 0.5 ml/min
 Temperature: 30 °C
 Detection: +ESI-MS

1. Indinavir
2. Nelfinavir
3. Saquinavir
4. Amprenavir
5. Ritonavir
6. Lopinavir

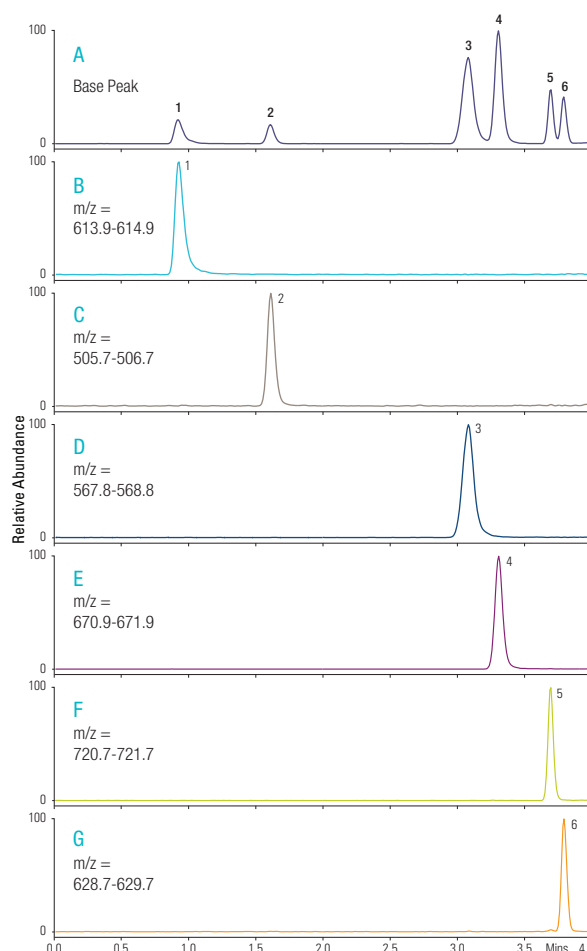

Figure 1. Single-ion monitoring of protease inhibitors

UHPLC COLUMNS ($\leq 2\mu\text{m}$ Particle Size)

- Decrease in analysis time
- Significant improvement in resolution
- Shorter columns with high separation efficiency
- Increased detection sensitivity

Introduction

There is an increasing demand for high throughput analysis and columns capable of ultra fast run times. A requirement for increased column efficiency has led to the development of smaller particle size materials. The introduction of ultra high pressure pumps and low dispersion hardware has enabled the use of smaller particle sizes to become more practical. However, many smaller particle columns have now been specifically designed so that they may still be used on conventional HPLC equipment, in addition to high pressure UHPLC systems.

Features of UHPLC Silica Particles

Resolution Equation

As the resolution equation shows, resolution (R_s) is proportional to the square root of separation efficiency (N). Efficiency is inversely proportional to particle size (dp). This means that when particle size is reduced, column length can also be reduced, whilst still maintaining constant efficiency. Using a shorter column with smaller particles, at the same flow rate as the larger particle column, means that analysis time can be considerably reduced. The optimal flow rates for particles of $\leq 2\mu\text{m}$ are higher than for 3 and $5\mu\text{m}$ particles (see Figure 1).

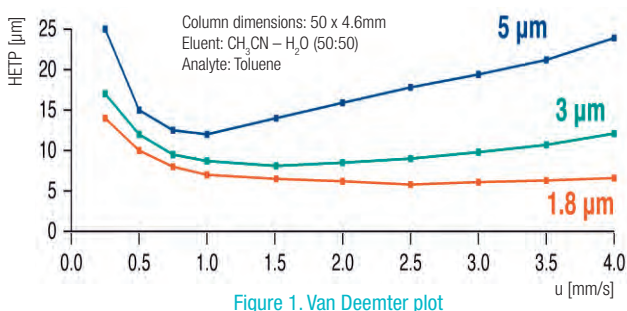

Table 1. Particle size effects

Particle Size (μm)	Resolution (R_s)	Efficiency (N) (plates/m)	Pressure (psi)
Proportional to	$1/dp^{1/2}$	$1/dp$	$1/dp^2$
2	2.97	200,000	5000
3	2.57	150,000	2250
3.5	2.39	130,000	2000
5	2.00	90,000	1000
10	1.48	50,000	300

Column: 100 x 4.6mm Eluent: CH₃OH – H₂O (85:15) Flow rate: 1.0ml/min Temperature: 22°C

Column Back Pressure

For columns with smaller particles the back pressure will increase inversely proportional to the square of the particle size. Table 1 illustrates that as particle size is reduced the column pressure is seen to increase more rapidly than resolution. For instance theoretically, when reducing the particle size from $5\mu\text{m}$ to $2\mu\text{m}$, the efficiency will more than double. This results in a resolution increase of nearly 50%, but pressure can be expected to increase by a factor of 5. At higher operating pressures, frictional heating of the eluent can become a significant factor, with a corresponding reduction of column efficiency and change of peak resolution and selectivity.

Selectivity

From the resolution equation above it can be deduced that selectivity (α) has a greater influence on a separation than attempting to improve efficiency alone. Therefore, it is strongly recommended that when a decrease in analysis time is required, selectivity effects are always investigated in addition to efficiency effects. Please contact us for further advice and support.

Instrument Requirements

Generally sub $2\mu\text{m}$ columns are available in short column lengths and small column i.d.s, leading to low column volumes. To maximise performance, the dead volume of the HPLC system has to be carefully considered and optimised irrespective of whether or not the columns are being operated at ultra high pressure. The use of high pressure, low dead volume column connectors is recommended (see page 66, for example), alongside low volume tubing and flow cells. In addition, fast data recording is required to ensure that the chromatographic performance is accurately recorded.

UHPLC Phases¹

Brand	Phase	Manufacturer	Particle Size (μm)	Page
ACE Excel	C18, C18-AR, C18-PFP, C8, C4, CN, Phenyl, AQ, SIL, SuperC18, C18-Amide, CN-ES	Advanced Chromatography Technologies	2	58, 65, 66, 71
Endeavorsil	C18	Dikma	1.8	82, 83
Epic	C18, C18-MS, C18-SD, C8, C4-SD, Phenyl-Hexyl, HILIC-HC, PFP-LB, SCX	ES Industries	1.8	85
Hypersil GOLD	GOLD, C8, C4, aQ, CN, PFP, Phenyl, Amino, AX, Polar, SAX, Silica, HILIC	Thermo Scientific	1.9	150
Inertsil	ODS-4, C8-4, ODS-3, C8-3, Phenyl-3	GL Sciences	2	87
InertSustain	C18		2	87
NUCLEODUR	C18 Gravity, C8 Gravity, C18 Pyramid, C18 Isis, Sphinx RP, HILIC, PolarTec, C18 PAH, C18 HTec, PFP	Macherey-Nagel	1.8	102
ProntoPEARL sub2 TPP	C18 ace-EPS, C8 ace-EPS, NH2	Bischoff	1.8	-
Purospher STAR	RP-18e, RP-8e	Merck	2	110
Synchronis	C18, C8, aQ, Phenyl, Amino, Silica, HILIC	Thermo Scientific	1.7	151
VisionHT	C18-HL, C18-B, C18, C18-P, HILIC, Silica	Grace	1.5	90
YMC-UltraHT	ProC18, Hydrosphere C18	YMC	2	-
YMC-Triart	C18, C8, Diol-HILIC, Phenyl, PFP	YMC	1.9	-

¹ For superficially porous phases please see page 16

Superficially porous particles (also called Fused-Core[®], core shell or Core Enhanced Technology[™] particles) consist of a solid silica core with a porous silica outer shell. These particles typically have diameters of 2.5 to 5µm. Columns packed with 2.5 to 2.7µm phases typically provide the efficiency and separation speed of sub 2µm UHPLC particles but at considerably lower back pressure. Columns packed with 5µm phases typically show comparable efficiencies to conventional porous 3µm columns.

Benefits of Superficially Porous Phases

High efficiency

Since diffusion only occurs in the porous outer shell and not the solid core, efficiency is increased compared to a totally porous particle of the same size. Resistance to mass transfer (C term in van Deemter equation) in superficially porous particles is reduced due to the limited diffusional path of the analytes (see Figure 1). For fast LC this results in high flow velocity without peak broadening. In addition, the tight control of particle diameter in superficially porous materials leads to highly uniform packed beds with minimised eddy diffusion, which also contributes to high efficiencies.

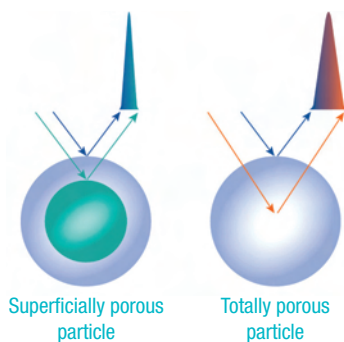

Figure 1. Mass transfer

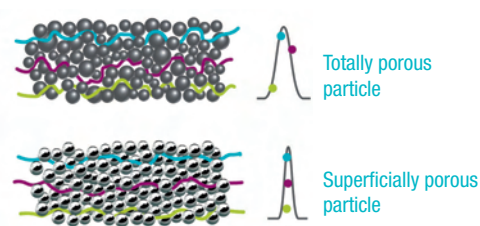

Figure 2. Eddy diffusion

Low back pressure

Superficially porous columns generate significantly lower back pressure compared to other UHPLC columns, facilitating rugged and reliable performance. Operating at these lower pressures avoids frictional heating of the eluent that could have negative effects on column efficiency and unpredictable changes in peak retention and column selectivity. Whereas sub 2µm phases require specialised UHPLC instrumentation to cope with the high pressures generated, superficially porous phases can be used with either UHPLC or conventional HPLC systems.

Robustness

The narrow particle size distribution of superficially porous materials enables the production of more uniformly packed column beds than found in totally porous particles. This leads to robust columns with long lifetimes. In addition, most superficially porous material columns use 2µm porosity column inlet frits, which reduces the inconvenience caused by pressure increases from plugged frits, which can occur with sub 2µm particles.

Columns for biomolecules

Wider pore superficially porous phases (e.g. 150, 160Å or 400Å) have been designed specifically to provide an optimum combination of retention and resolution for peptides and small proteins.

Method conversion from fully porous phases

The larger 4 and 5µm superficially porous phases can be used to directly replace conventional methods developed on the same chemistry columns using standard HPLC instruments, without any changes to instrument configuration or method conditions. Higher efficiencies and higher sensitivities can be generated using these 4 and 5µm superficially porous phases. In addition to reproducing established conventional methods, these 4 and 5µm phases enable methods to be modified to include reduced analysis times and hence increased productivity.

Superficially Porous Phases

Brand	Phase	Manufacturer	Particle Size (µm)	Pore Size (Å)	Page
Accucore	RP-MS, C18, aQ, C8, Phenyl-Hexyl, PFP, Phenyl-X, HILIC, Urea-HILIC	Thermo Scientific	2.6	80	149
	150-C18, 150-C4, 150-Amide-HILIC, Polar Premium, C30	Thermo Scientific	2.6	150	149
Accucore XL	C18, C8	Thermo Scientific	4	80	149
ACE UltraCore	SuperC18, SuperPhenylHexyl	Advanced Chromatography Technologies	2.5, 5	95	1
Brownlee SPP	C18, C8, HILIC, PFP, Phenyl-Hexyl, RP-Amide	Perkin Elmer	2.7	90	-
	Peptide ES-C18	Perkin Elmer	2.7	160	-
HALO	C18, C8, HILIC (Silica), RP-Amide, Phenyl-Hexyl, PFP, ES-CN, Penta-HILIC	Advanced Materials Technology	2.7	90	91
	Peptide ES-C18, Peptide ES-CN	Advanced Materials Technology	2.7	160	91
HALO-5	C18, C8, PFP, Phenyl-Hexyl, ES-CN, HILIC, Penta-HILIC, Peptide ES-C18, Peptide ES-CN	Advanced Materials Technology	4.6	90	91
HALO	Protein C4	Advanced Materials Technology	3.4	400	91
NUCLEOSHELL	RP 18, HILIC, PFP, Phenyl-Hexyl	Macherey-Nagel	2.7	90	102

METHOD TRANSFER FROM HPLC TO UHPLC

The use of UHPLC (Ultra High Performance Liquid Chromatography) and superficially porous particles enables columns with smaller i.d. and shorter lengths to be used on low dispersion, high pressure instrumentation. This results in faster analyses and increased sample throughput. Frequently, these faster methods are derived from the conversion of an established method on a conventional HPLC column (e.g. 3 or 5µm) to small format columns packed with 2 or sub 2µm particles or superficially porous particles. It should be noted that this section looks at the benefits resulting from decreasing particle size only and the benefits of adjusting selectivity should not be ignored (see page 30). In order to realise the full benefits of these faster methods, care must be taken to ensure that operating flow rate, injection volume and gradient profile are adjusted appropriately, without exceeding the pressure limitations of the instrument.

In addition, since peaks elute from ultra-fast columns faster and with much smaller volumes than conventional columns, modifications may have to be made to conventional HPLC equipment (see page 19) to obtain the full benefits and avoid problems. Other factors such as column connections and tubing also become highly important.

In the sections below it is assumed that the column chemistry of the original and ultra-fast column is the same, preferably the same brand, with the same pore size and carbon load. This will ensure that the selectivity of the original separation is preserved, with only minor changes occurring. This is often referred to as the scalability of the material. The equations below are given as guidelines for the conversion from fully porous HPLC to fully porous UHPLC columns. For superficially porous columns, column void volumes will be lower than for the equivalent dimension fully porous column, as a higher percentage of the column is taken up by stationary phase and additional criteria need to be considered. Please contact Hichrom for additional information and advice on this.

Isocratic Method Transfer

If particle size only is reduced, whilst maintaining column dimensions, an improvement in efficiency is observed. However, for a reduction in analysis time, column dimensions also need to be reduced.

Adjustment of column dimensions

When converting a conventional separation to an ultra-fast separation, the shortest ultra-fast column should be chosen that will provide resolving power equal to or better than the conventional column it is replacing. This will allow run time to be minimised whilst maintaining acceptable resolution. This is accomplished by using columns that have the same ratio of column length to particle size. Equation 1 shows the relationship between column length and particle size.

$$L_2 = L_1 \times \frac{d_{p2}}{d_{p1}}$$

where L_1 = length of conventional column
 L_2 = length of UHPLC column
 d_{p1} = particle size of conventional column
 d_{p2} = particle size of UHPLC column

Equation 1. Adjustment of column dimensions

For example, using this equation, it can be seen that a 2µm, 100mm length column will maintain the same separation (efficiency and resolution) as a 3µm, 150mm length column.

Adjustment of flow rate

In order to maintain an equivalent separation when transferring a method, the linear velocity must be kept constant between the original and new method. This is achieved by decreasing the flow rate proportionally to the column internal diameter. Equation 2 shows the relationship between flow rate and column internal diameter. It is assumed that the stationary phase and the column length are kept the same.

$$F_2 = F_1 \times \left(\frac{d_{c2}}{d_{c1}}\right)^2$$

where F_1 = original flow rate
 F_2 = new flow rate
 d_{c1} = i.d. of original column
 d_{c2} = i.d. of new column

Equation 2. Adjustment of flow rate

For example, if a method is converted from a 5µm, 100 x 4.6mm column run at 1ml/min to a 2µm, 100 x 2.1mm column, the flow rate giving the same linear velocity is 0.21ml/min.

Since the optimum flow velocity of an ultra-fast column is faster than for a conventional column, it may be possible to reduce run time, with no or negligible loss in resolution, by operating at a higher flow rate. However, care must be taken not to exceed the pressure limitation of the system or column.

METHOD TRANSFER FROM HPLC TO UHPLC (continued)

Estimation of back pressure

Back pressure is directly proportional to column length and inversely proportional to the square of the column diameter. Such pressure is inversely related to the square of the particle size and directly affected by flow rate. These changes can be represented by equation 3.

$$P_2 = P_1 \times \frac{L_2}{L_1} \times \left(\frac{d_{c1}}{d_{c2}}\right)^2 \times \left(\frac{d_{p1}}{d_{p2}}\right)^2 \times \frac{F_2}{F_1}$$

Equation 3. Estimation of back pressure

where P_1 = original column pressure
 L_1 = original column length
 d_{c1} = i.d. of original column
 d_{p1} = particle size of original column
 F_1 = original flow rate

P_2 = new column pressure
 L_2 = new column length
 d_{c2} = i.d. of new column
 d_{p2} = particle size of new column
 F_2 = new flow rate

This equation can be used to check that the back pressure due to the increased flow rate of the new method does not exceed the limitations of your system.

Adjust injection volume

When the column length and internal diameter are decreased, the overall column volume and sample capacity are also decreased. If the same sample injection volume is used, this will fill a larger proportion of the ultra-fast column volume which could result in band broadening and column overload. The injection volume must therefore be scaled down according to the decrease in column volume. The injection volume in UHPLC can be calculated from Equation 4. In practical terms, the injection volume should be between 1-5% of the column volume in order to avoid overload.

$$V_{i2} = V_{i1} \times \left(\frac{d_{c2}}{d_{c1}}\right)^2 \times \frac{L_2}{L_1}$$

Equation 4. Adjustment of injection volume

where V_{i1} = original injection volume
 d_{c1} = i.d. of original column
 L_1 = length of original column

V_{i2} = new injection volume
 d_{c2} = i.d. of new column
 L_2 = length of new column

Figure 1 illustrates the considerable reduction in analysis time achieved when transferring from a 5 μ m, 150 x 4.6mm i.d. column to a 2 μ m, 50 x 2.1mm i.d. column. A further reduction in analysis time is achieved by increasing the flow rate by a factor of 4. The pressure increase is within the limits of the UHPLC system.

Column: C18 (5 μ m, 150x 4.6mm)
 Eluent: CH₃CN - H₂O - HCO₂H (35:65:0.1)
 Flow rate: 1.0ml/min (1.0mm/sec)
 Temperature: 40°C
 Pressure: 1230psi (83 bar)

A. Conventional LC method
 C18 5 μ m, 250 x 4.6mm i.d.

1. Myricetin
 2. Quercetin
 3. Apigenin
 4. Kaempferol
 5. Baicalein
 6. Chrysin
 7. Acacetin

Column: C18 (2 μ m, 50 x 2.0mm)
 Eluent: CH₃CN - H₂O - HCO₂H (35:65:0.1)
 Flow rate: 0.6ml/min (3.2mm/sec)
 Temperature: 40°C
 Pressure: 4350psi (292 bar)

B. Ultra fast LC method
 C18 2 μ m, 50 x 2.0mm i.d.

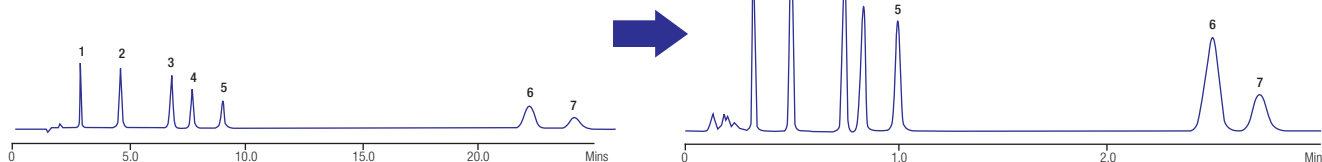

Figure 1. Conversion of HPLC to UHPLC method

Gradient Method Transfer

Following adjustment of column dimensions, flow rate and injection volume, as discussed above for isocratic separations, the gradient time can then be adjusted for each step of the gradient. The new calculated gradient should take place over the same number of column volumes of eluent as in the gradient with the initial column. The initial and final solvent compositions are kept the same. If the dwell volumes of the original and new UHPLC/HPLC systems are different, it may be necessary to introduce an isocratic hold into the method to allow for this.

$$t_{g2} = t_{g1} \times \frac{F_1}{F_2} \times \left(\frac{d_{c2}}{d_{c1}}\right)^2 \times \frac{L_2}{L_1}$$

Equation 5. Adjustment of gradient profile

where t_{g1} = gradient time in original method
 F_1 = original flow rate
 d_{c1} = i.d. of original column
 L_1 = length of original column

t_{g2} = gradient time in new method
 F_2 = new flow rate
 d_{c2} = i.d. of new column
 L_2 = length of new column

METHOD TRANSFER FROM HPLC TO UHPLC (continued)

Instrument Considerations

In order to obtain the best data using fast chromatography, it is essential that the LC instrument is optimised for the conditions to be used. Extra column volume is the volume in an HPLC system external to the column that contributes to the total peak volume and therefore band broadening. Extra column effects are far more significant for scaled down separations because of the smaller column volumes involved.

Minimising system volume

In particular, system volume must be minimised. Connecting tubing i.d. and length, injection volume, volume of UV flow cell and any volume added by heat exchangers, fittings, connectors and inline filters must be kept as small as possible. In general, in order to get 90% of the maximum resolution from a column, the extra column volume should be less than half of the total peak volume.

Making good UHPLC connections

When installing any UHPLC column, it is important to ensure that the high pressure inlet tubing is fitted into the column port to the correct depth to avoid the introduction of any extra column volume. Incorrect positioning of the inlet tubing, ferrule and nut can result in a significant loss in efficiency and deterioration in asymmetry. Figures 2 and 3 illustrate correctly and incorrectly fitted tubing. The tubing that is incorrectly fitted shows a gap between the tubing and the column frit which will lead to the introduction of extra column volume. This gap may result from either poor initial connection, possibly as a result of using connectors pre-swaged to the tubing, or tubing slippage subsequent to connection. It is recommended that a new connection is made every time a new UHPLC column is installed to help avoid this problem.

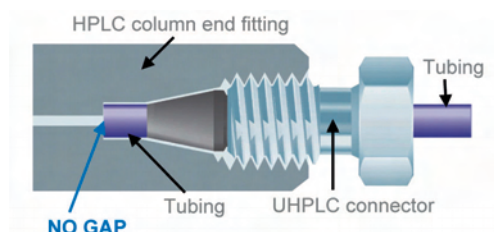

Figure 2. Tubing correctly fitted

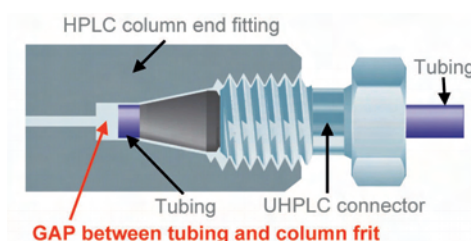

Figure 3. Tubing incorrectly fitted

Dwell volume

For gradient separations the pump dwell volume is of particular importance, as it affects the time taken for the gradient to reach the head of the column, i.e. it effectively adds an isocratic hold to the beginning of the gradient. This will have more of an effect on early eluting peaks. To minimise the effect on a separation, the dwell volume should be kept as small as possible, by using micro gradient mixers and keeping the system tubing volume to a minimum.

Filtering of solvents and samples

The frits used in UHPLC columns are generally of smaller pore size than those of conventional HPLC columns and therefore more prone to clogging. As a result, it is critical to ensure that any potential small particles are removed from the eluent. In order to ensure the absence of insoluble particles it is recommended that high grade organic solvents and ultra pure water are used. Eluents used should always be freshly prepared in order to avoid microbiological growth.

Detector flow cell and sampling rate

When short narrow UHPLC columns are used, the peaks generated are narrower than in conventional HPLC. Smaller, lower dispersion flow cells with volumes of $4\mu\text{l}$ or even $1\mu\text{l}$ are preferred for UHPLC. In addition, the detector time constant and data collection rate should be set fast enough for sufficient peak information to be collected, otherwise resolution, efficiency and analytical accuracy will be compromised.

Method Transfer from UHPLC to HPLC

Similar considerations need to be made when transferring methods from UHPLC to HPLC as for HPLC to UHPLC. Please contact Hichrom for additional information and advice on this.

Superficially Porous Columns

Please contact Hichrom for additional information and advice on transferring methods from HPLC to superficially porous type particles.

- Protection for columns from 1.0 - 30mm i.d.
- No loss in column performance or selectivity
- Significantly extends column lifetime
- Packed with the same high performance silica used in main column
- Stand alone or integral design
- Tested to ensure consistent high level performance
- Readily disposable and cost effective

Introduction

Guard cartridges are designed to protect valuable analytical and preparative HPLC columns from contamination with impurity particles and irreversibly adsorbed solutes. By placing a guard cartridge between the column and the injector valve, contaminants which would otherwise damage the column are trapped on the disposable cartridge. This procedure significantly extends column lifetime without affecting performance or selectivity (see Figure 1). Without column protection, column fouling can lead to increased back pressure and peak splitting and/or severe peak tailing.

Silica

It is recommended that guard cartridges are packed with the same silica and bonded phase as used in the HPLC column to be protected (this eliminates the possibility of any loss of performance or selectivity). All Hichrom cartridges conform to this requirement. As Hichrom is able to supply cartridges packed with any commercially available silica, virtually all analytical and preparative columns can be suitably protected.

Guard Cartridge Holder System

For traditional analytical columns (with compression end fittings) a fingertight column coupler (HI-081) is required to connect the stand alone holder (HI-161) to the column (see Figure 2). Similar arrangements are available for semi-preparative (7.75 - 21.2mm i.d.) and preparative (30mm i.d.) columns, as detailed on the following page.

Guard Cartridge Replacement

It is generally recommended that for effective column protection, guard cartridges should be replaced when the column back pressure increases by 10% or column efficiency or resolution decreases by 10%.

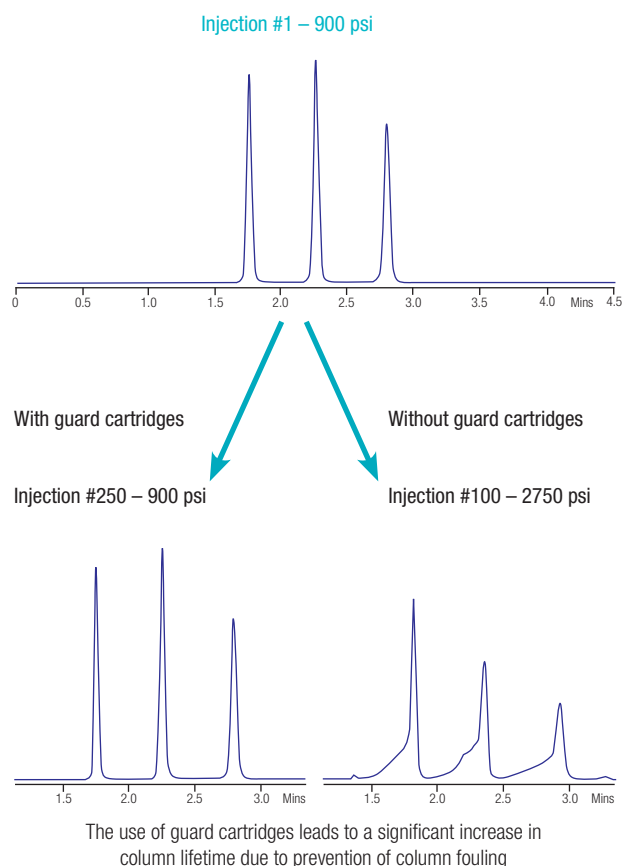

Figure 1. Increased column lifetime

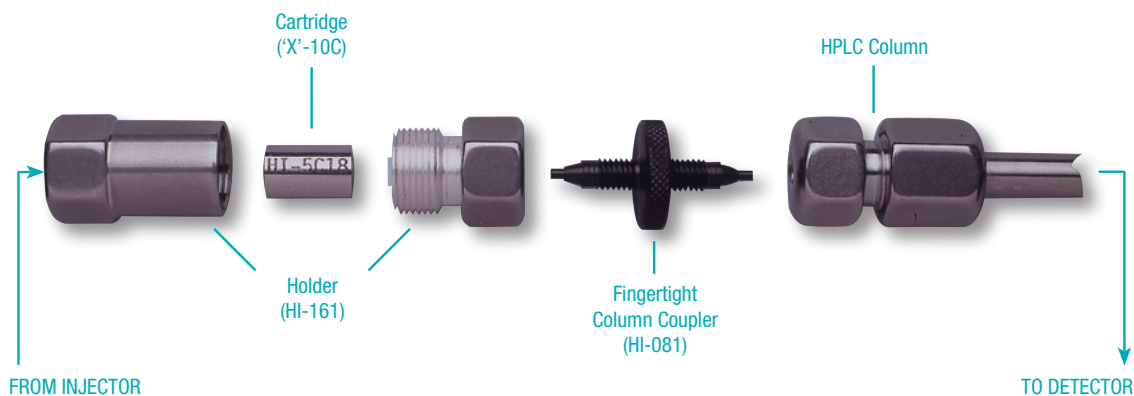

Figure 2. Stand alone guard cartridge system for traditional analytical columns

HICHROM GUARD CARTRIDGES (continued)

Ordering Information - Hichrom Manufactured Guard Cartridges

Guard Cartridge ³	Catalogue No. ¹	Pack Quantity	Holder	Coupler
For 1.0mm i.d. columns	X-10CE5	5	HI-161	HI-081
For 2.1mm i.d. columns	X-10CM5	5	HI-161	HI-081
For 3.2 - 4.6mm i.d. columns	X-10C5	5	HI-161	HI-081
For 7.75 - 21.2mm i.d. columns	X-10CP3	3	HI-150	HI-081
For 30mm i.d. columns	X-20CP	1	HI-183 ²	HI-083

¹ When ordering replace 'X' with the appropriate silica code - see column listings or contact Hichrom for details.

Example: For a 5 pack of Hichrom 5 C18 guard cartridges for 3.2 - 4.6mm i.d. columns, Catalogue No. = HI-5C18-10C5

² A new improved holder HI-655 for use with new guards X-10CB3 (3/pk) is now available

³ Guard cartridges for 50mm i.d. columns are also available – please enquire

Starter Kits

Starter kits (see Figure 3) contain five guard cartridges packed with any chosen silica, a free-standing holder (HI-161) and a fingertight column coupler (HI-081).

Starter Kit	Catalogue No. ¹
For 1.0mm i.d. columns	X-10CE5-SK
For 2.1mm i.d. columns	X-10CM5-SK
For 3.2 - 4.6mm i.d. columns	X-10C5-SK

¹ When ordering replace 'X' with the appropriate silica code - see column listings or contact Hichrom for details.

Example: For a Hichrom 5 C18 starter kit for 3.2 - 4.6mm i.d. columns,

Catalogue No. = HI-5C18-10C5-SK

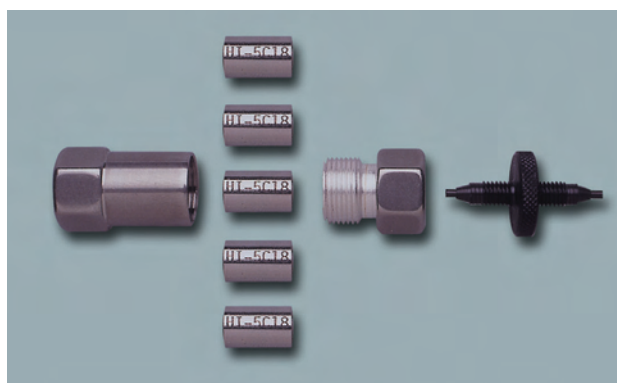

Figure 3. Guard cartridge starter kit

ColumnSaver Pre-Column Filters

- Economical column protection
- Protect columns from particulates
- Compatible with all HPLC columns
- Ultra-low dead volume

Placed immediately before the column, pre-column filters trap sample particulates and provide a convenient, lower cost solution than the use of guard cartridges (see p.20/21). However, for samples that may irreversibly adsorb onto the column, guard cartridges remain the preferred choice for maximum column protection.

The ColumnSaver pre-column filter is simply hand tightened into the column inlet (no tools are required), and is leak-proof to over 5000psi. Both 2µm and 0.5µm versions are available, for protection of 5µm and 3µm columns respectively.

ColumnSaver pre-column filters are universally compatible with all column manufacturers' end fittings, and may be used with either stainless steel or PEEK tubing and nuts (see Figure 4). It is recommended that pre-column filters are replaced when a 10-20% increase in back pressure is detected.

Please see page 194 for column filter protection for UHPLC and superficially porous columns.



Figure 4. Column with pre-column filter

Description	Catalogue No.
2µm ColumnSaver (10/pk)	HI-685
0.5µm ColumnSaver (10/pk)	HI-686

- Wide range of bulk silicas
- Particle sizes 5 - 50µm
- Column internal diameters 10 - 100mm (4’)
- Analytical matched test columns
- High purity products
- Good recoveries

Introduction

Preparative HPLC is used to isolate and purify milligram to kilogram amounts of compound. The technique uses larger particle size silica materials and wider internal diameter columns than in analytical HPLC. Column efficiency can be preserved on scale-up from analytical to preparative separations. However, broader lower efficiency chromatographic peaks are more often observed when the column is used in an overload state.

Separation Criteria

The criteria governing preparative separations are very similar to those influencing analytical HPLC. However, economic considerations become more important. They are governed by four factors.

- 1) Resolution** – By optimising the separation between the peak of interest and the nearest contaminant, high sample loads can be achieved without compromising product purity.
- 2) Loadability** – Loadability is controlled by the silica’s pore size and available surface area. The smaller the pore size the larger the surface area and the higher the potential loadability. The comparative loadability of different pore size silicas is shown in Figure 1. However, application of the smaller pore size silicas is limited by the range of molecular weight materials they can separate.
- 3) Chemical stability** – The lifetime of a column is often dependent on the silica’s chemical stability. Conditions of use are very important.
- 4) Physical stability** – Larger preparative and process scale columns are often repacked during their lifetime. The robustness of a silica will determine how many times a material can be successfully repacked into a column.

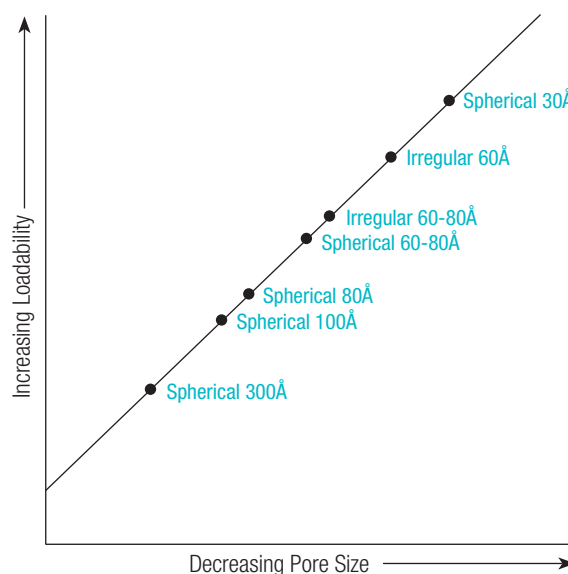

Figure 1. Comparative loadability of different pore size silicas

Separation Strategy

Reversed-phase is the dominant technique used in analytical HPLC. However, normal-phase HPLC is still often used in preparative separations due to the high cost of reversed-phase materials and the easier recovery of solute from the organic solvents used.

Two strategies dominate the approach to preparative HPLC. In the ‘scale-up’ approach, a method developed for analytical purposes is directly applied to a larger i.d. column. Although typical 3 - 5µm particles may be replaced with 10µm material of identical selectivity, high preparative efficiencies are maintained. Such an approach is particularly suitable for purifying gram quantities of material with low k values.

In the alternative ‘overload’ approach, resolution is sacrificed by operating the column in an overload situation. Resolution needs only to be maintained between the peak of interest and the nearest contaminant. Such high loadings maximise column capacity. Separations are poorer but gram to kilogram amounts of material may be purified.

Figure 2 illustrates a typical preparative method development strategy. The extent to which the analytical column can be overloaded, whilst still maintaining adequate resolution and peak shape, is first determined (Figure 2(b)). The injection volume is then scaled up in line with the flow rate increase, used to maintain the same linear velocity through the preparative column (Figure 2(c)).

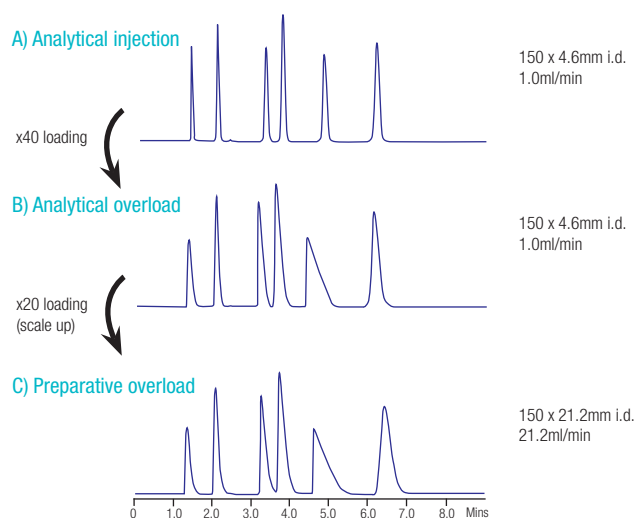

Figure 2. Scale-up strategy using C18 column

PREPARATIVE AND PROCESS SCALE COLUMNS (continued)

A comparison of scale-up parameters is highlighted in Table 1.

Table 1. Typical sample capacities

Column Size	Column i.d. (mm)	Relative Flow Rate (ml/min)	Volume of 250mm Length Column (ml)	Weight of Phase ¹ (g)	Typical Injection Volume (µl)	Maximum Column Capacity per Injection	
						Optimum	Overload
Analytical	4.6	1.0	4.2	2.5	10	2mg	85mg
Semi-preparative	7.75	2.8	12	7	30	6mg	240mg
Semi-preparative	10	4.7	20	12	50	10mg	400mg
Preparative	21.2	21	90	53	200	45mg	1.8g
Preparative	30	42.5	177	106	400	90mg	3.6g
Process	50	118	490	295	1200	250mg	10g
Process	100	473	1964	1182	4800	1g	40g

¹ Assumes 250 x 4.6mm column contains 2.5g material

Bulk Preparative Materials

Hichrom distributes a large number of commercially available preparative HPLC bulk materials. The physical properties of a selection of these are listed below. Please note that for a given brand not all chemistries are available in all particle sizes and pore sizes.

Material ¹	Manufacturer	Particle Size (µm)	Particle Shape ²	Pore Size (Å)	Surface Area (m ² /g)	Chemistry	Page
Daisogel	Daiso Co.	7, 10, 15, 20, 50	S	60, 100, 120, 200, 300, 1000, 2000	450, 450, 300, 200, 100, 25, 15	Sil, C18, C8, C4, C1, NH ₂	-
Develosil	Nomura Chemical Co.	10, 10-20, 15-30	S	30, 60, 100	760, 500, 320	Sil, C18	80
Impaq	Silicycle	5, 10, 20, 40	I	60, 100	500, 400	Sil, C18	-
		7, 10, 13, 16	S	60	540	Sil, CN, Diol	-
Kromasil	Akzo Nobel	7, 10, 13, 16	S	100	320	Sil, C18, C8, C4, NH ₂ , Phenyl	-
		10, 16	S	300	110	Sil, C18, C8, C4	-
LiChroprep	Merck	15-25, 25-40, 40-63	I	60, 100	500, 300	Sil, C18, C8, NH ₂ , CN, Diol	114
		10, 30	S	120, 250, 600	Polyhydroxymethacrylate based resins		108
MCI GEL	Mitsubishi Chemical Corp.	Various	S	250, 450	Non-functionalised styrene-divinylbenzene copolymer for RP		108
		Various	S	-	Styrene-divinylbenzene copolymer ion-exchange resins		108
SiliaSphere PC	Silicycle	20-45, 40-75, 75-200	S	70, 100, 300, 1000	500, 280, 100, 50	Sil, C18	-
Vydac	Grace	10-15, 15-20, 20-30	S	300	-	C18, C8, C4, Phenyl	90
YMC ProC18		10	S	120	-	C18	-
YMC HG Series	YMC	10, 15, 20, 50	S	120, 200, 300	330, 175, 100	Sil, C18, C8, C4, C1, Phenyl, NH ₂ , CN, Diol	-
YMC Triart Prep		10, 15, 20, 50	S	120, 200	-	C18, C8	-
YMC BioPro		10, 30, 75	S	1000	-	QA, SP	-

¹ Not all chemistries available in all particle sizes and pore sizes

² S=Spherical, I=Irregular

A large range of bulk resins from Tosoh Bioscience is also available – please contact Hichrom for further details.

Introduction

In reversed-phase HPLC, the pH of the eluent can significantly influence the separation of components. Buffers are required when the sample contains ionic or ionisable analytes. Without a buffer, poor peak shape and variable retention may result.

In general, for acids, increasing eluent pH leads to increased ionisation and a decrease in retention (see Figure 1). For bases, decreasing the pH results in greater ionisation and decreased retention. For robust methods, separations should be developed at a pH where retention is least affected by pH change (see robust pH zones in Figure 1).

Choice of Buffer pH

Optimum buffering capacity occurs at a pH equal to the pK_a of the buffer. In general, the effective pH range for a buffer is within ± 1 pH unit of its pK_a . Table 1 indicates the pH range of some common buffers. The buffer pH should be selected so that it is at least ± 1 pH unit from the pK_a of the analyte. This will ensure that the analytes are 100% ionised or 100% non-ionised, for reproducible retention.

Further Considerations

At $pH > 7$, phosphate buffers accelerate the dissolution of silica. For optimum column lifetime, organic buffers (e.g. pyrrolidine) should be used for pH above 8. Buffer concentrations in the 10 – 25mM range are recommended (maximum 50mM) to prolong column lifetime and reduce the possibility of system wear and tear. Fresh buffer solutions should be prepared regularly and pre-column filters should be used to protect columns. Buffers should be flushed from the column prior to storage.

Buffers for LC-MS

For LC-MS analyses, volatile buffers or additives are preferred, in order to minimise MS ion suppression and maintain sensitivity. In addition, non-volatile buffers such as phosphate may lead to contamination of the ion source. Buffer concentrations should be as low as possible e.g. 10 to 20mM. Ammonium salts are more volatile than those of Na^+ or K^+ . TFA should be avoided with electrospray LC-MS as it reduces sensitivity. Formic acid or acetic acid (0.01 to 1% v/v) are preferred. For higher pH applications, ammonium hydroxide is recommended.

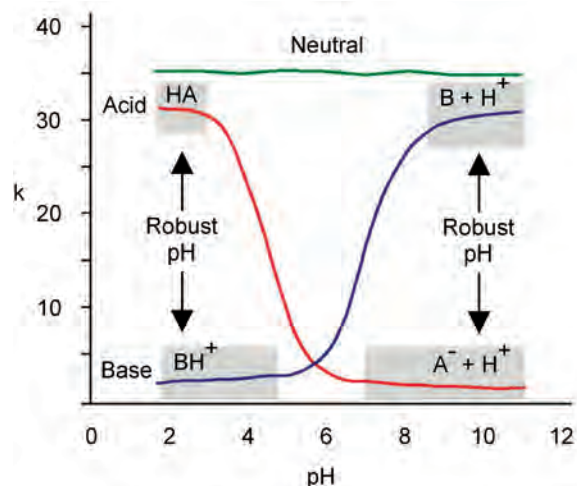

Figure 1. pH Effect on retention

Table 1. Common Buffers and Additives for HPLC

Buffer or Additive	pK_a	pH Range	UV Cut-off (nm)	MS Compatible
TFA	0.3	-	210 (0.1%)	Yes – low levels
Phosphate	2.1	1.1 – 3.1	200	No
	7.2	6.2 – 8.2		
	12.3	11.3 – 13.3		
Formic acid	3.8	-	210	Yes
Formate	3.8	2.8 – 4.8	210 (10mM)	Yes
Acetic acid	4.8	-	210	Yes
Acetate	4.8	3.8 – 5.8	210 (10mM)	Yes
Citrate	3.1	2.1 – 4.1	230 (10mM)	No
	4.7	3.7 – 5.7		
	5.4	4.4 – 6.4		
Bicarbonate	6.4	5.4 – 7.4	200 (10mM)	Yes
	10.3	9.3 – 11.3		
Ammonia / ammonium hydroxide	9.2	8.2 – 10.2	200 (10mM)	Yes
Borate	9.2	8.2 – 10.2		No
Tris	8.3	7.3 – 9.3	205 (10mM)	No
1-Methylpiperidine	10.1	9.1 – 11.1	215 (10mM)	Yes
Diethylamine	10.5	9.5 – 11.5		Yes
Pyrrolidine	11.3	10.3 – 12.3	200	Yes

Introduction

Proteomics is the analysis of the protein complement present in a cell, organ or organism at any given time. The application of proteomic technologies is key to the understanding of healthy and diseased conditions. Proteomics involves the identification of all the proteins made in a given cell, tissue or organism and understanding how these proteins function and the determination of their 3D structures. This information can be used to help identify biomarkers and target sites for drug interaction. In addition to applications in biochemistry and medicine, proteomics can also be applied in plant and crop biotechnology research.

Many proteins are subjected to a wide variety of post-translational chemical modifications. These all contribute to the composition and functioning of the proteome. Typical modifications include phosphorylation, glycosylation, oxidation, acetylation etc.

Techniques

A typical cell produces hundreds of thousands of different proteins. Enzymatic digestion (e.g. with trypsin) of extracted proteins, or those separated by 2D gel electrophoresis, generates a range of peptides in the digest. Multidimensional LC-MS/MS can be used to separate and sequence these peptides. The 2D HPLC approach increases the resolving power of the separation, by combining reversed-phase with ion-exchange, HILIC or affinity techniques. This reduces the complexity of the peptide mixture being analysed, improving detection chances for less abundant species.

Due to the limited amounts of sample generally available, microbore and capillary/nano columns are now preferred. Experimental electrospray MS/MS data is matched against sequence-analysis identification software.

Many products listed in this catalogue can be used for proteomic studies.

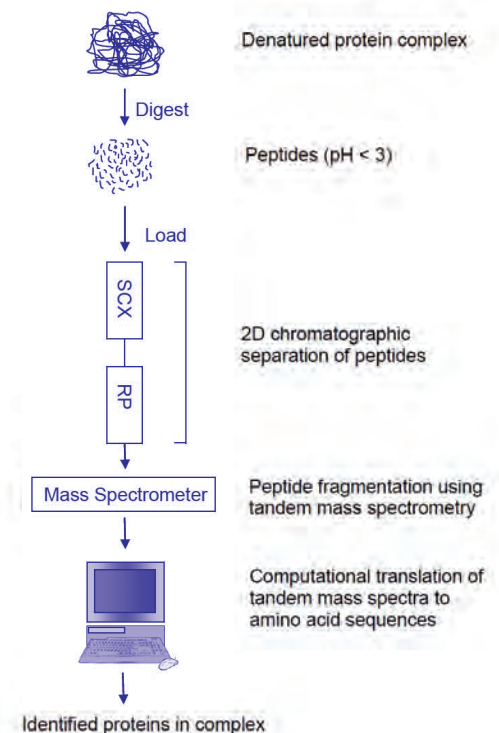

Figure 1. Proteomics by 2D LC-MS/MS

HPLC Columns

Capillary and LC-MS columns are discussed on pages 13 and 14 respectively. In addition to reversed-phase columns, ion-exchange (p.46), HILIC (p.44) and affinity columns (p.50) are also used in 2D analysis.

A selection of suitable columns can be found on the following pages.

Reversed-phase columns: Acclaim PepMap (p.153), ACE (p.58), Cogent (p.115), HALO (p.91), Inertsil (p.87), NUCLEOSIL (p.102), Vydac (p.90).

Ion-exchange columns: BioBasic (p.153), MCI GEL (p.107), PolyLC (p.127), Shodex (p.140), TSKgel (p.155).

HILIC columns: PolyLC (p.127), TSKgel (p.155), ZIC-HILIC (p.109).

Affinity columns: ProPac (p.153), Shodex (p.142), TSKgel (p.155).

Speciality columns: Titansphere (p.89) – especially effective in the isolation of phosphopeptides
Cogent Diamond Hydride (p.116) – silicon-hydride bonding
Hypercarb (p.150).

Sample Preparation

In addition to conventional SPE products (see page 175), more specialised products have applications for sample pre-treatment of low level proteins and peptides.

Pipette and syringe tips can separate very low sample volumes, prior to HPLC, MALDI and electrophoresis (see page 177). Tips packed with the following materials are available: PolyLC, titania, monolithic and others. Please contact us for further details.

Titansphere Phos-TiO kits: Kits containing titania packed tips, waste and collection tubes for enrichment of phosphopeptides. Please contact us for further details.

MonoSpin TiO: Monolithic SPE centrifugal spin columns for enrichment of phosphopeptides. Please contact us for further details.

Metabolomics is defined as the quantitative measurement of all low molecular mass metabolites in an organism's cells at a specific time under specific environmental conditions. A metabolome represents the complete set of small molecule metabolites, which are the intermediates and products of metabolism, found in a biological cell, tissue, organ or organism. In general, for metabolomics, a metabolite is usually defined as any molecule less than 1kDa in size.

Metabolomic Techniques

In targeted metabolomic analysis, the compounds in a given biofluid or tissue extract are identified and quantified by comparing the spectrum of interest to a library of reference spectra. This is generally used for the determination of a few specific known metabolites.

Metabolic profiling involves the qualitative or quantitative determination of a particular class of metabolites or compounds from a specific metabolic pathway.

Metabolic fingerprinting compares the patterns of metabolites and helps to distinguish between samples based on the metabolites characterised.

Separation and Detection Methods

Due to the chemical diversity of small molecule metabolites, it is not possible to study the entire metabolome using a single analytical technique or technology. Therefore, a variety of targeted and non-targeted methods are applied and the data integrated in order to obtain as much information as possible regarding metabolite content.

GC and GC-MS are able to detect a wide range of compounds. Volatile components can be analysed by headspace GC-MS. For some less volatile metabolites, compounds are derivatized prior to GC analysis.

HPLC and LC-MS are the most common separation techniques used for targeted analysis and for metabolic profiling of individual classes. The simultaneous measurement of hundreds of secondary metabolites in samples can be achieved using gradient HPLC. Reversed-phase HPLC columns are most widely used, but HILIC separations of polar metabolites have also been described. Figure 1 shows the extracted ion chromatograms from a mixture of sugars and sugar alcohols, found in plants, by HILIC-MS.

Direct injection MS may be used to obtain metabolite mass profiles, without any chromatographic separation. Using electrospray ionisation, mainly protonated or deprotonated ions are formed for each species, with very little fragmentation. A fingerprint spectrum of metabolites is obtained, with metabolites being separated by accurate molecular mass.

Multivariate analysis. Due to the complex nature of a metabolome, it is difficult to make a visual comparison of the large numbers of spectra and chromatograms. As a result, data analysis and interpretation is often accomplished using a chemometric approach, including principal component analysis (PCA).

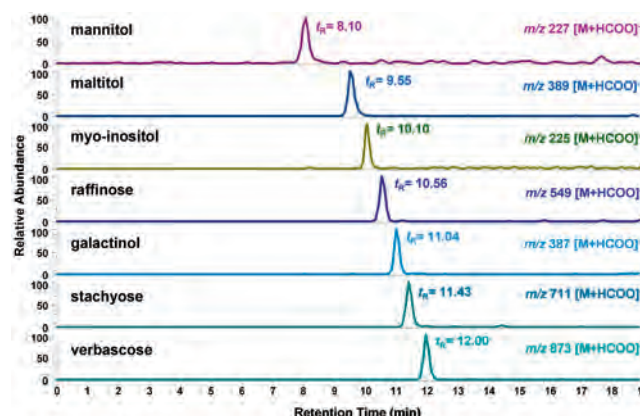

C. Antonio, T. Larson, A. Gilday, I. Graham, E. Bergström, J. Thomas-Oates, *Rapid Commun. Mass Spectrom.*, 22 (2008) 1399-1407

Column: ZIC-HILIC (3.5µm, 150 x 2.1mm)
 Eluent: A: CH₃CN – 0.1% formic acid
 B: 5mM ammonium acetate, 0.1% formic acid, pH 4
 Gradient: 10% to 90% B in 19mins
 Detection: MS

Figure 1. Analysis of plant metabolites by HILIC-MS

Application Areas

Clinical – Metabolomics is of interest to medical science as it may lead to improvements in the diagnosis and treatments of human diseases. Finding unique patterns of metabolites could aid the identification of a target enzyme or protein (biomarker) for the disease, resulting in faster drug development.

Toxicology – Metabolomic profiling of urine and blood samples can detect physiological changes caused by toxic chemicals. This is used in the pharmaceutical industry for toxicity testing of potential drug candidates.

Nutrition – Metabolomics can be used for physiological monitoring in food intervention or diet challenge studies.

Food – Metabolomics is used as an aid to developing high performing crop varieties, e.g. it provides biomarkers of flavour in tomatoes and other fruit and vegetables. It is also used in food quality testing and the detection of food adulteration.

Environmental – Metabolomics is used to study the interactions of organisms with their environment and has applications in the fields of ecology and ecophysiology.

Column Availability

A wide range of columns suitable for metabolomic analyses are supplied by Hichrom:

GC columns – see p.167-170

RP HPLC columns – see p.33-43

HILIC columns – e.g. ZIC-HILIC (p.109), TSKgel Amide-80 (p.155), PolyLC (p.127), also see p.44

Speciality columns – e.g. Cogent Diamond Hydride (p.116)

- Fast analyses
- Reduced solvent consumption
- High flow rates possible
- Lower cost per sample
- Compatible with MS
- Excellent for preparative separations

Introduction

Supercritical fluid chromatography (SFC) is a chromatographic technique which uses a supercritical fluid as the mobile phase. Although SFC has been around for some time, its adaptation as an orthogonal technique to HPLC, particularly in the pharmaceutical industry, has seen an increase over the last few years. This interest has been fuelled by the increasing requirement for high throughput and a desire for 'greener' techniques. Large reductions in the use of solvents have significant benefits in terms of decreased sample processing and drying-down times, as well as providing cost and safety benefits.

In SFC the mobile phase consists of a 'fluid', either a gas or a liquid above its critical temperature and pressure. Liquefied CO₂ is most commonly used as the main fluid, with the addition of a modifier fluid such as methanol to aid elution of very polar or ionic compounds. The modifier improves the solvating power of the supercritical fluid and enhances the selectivity of the separation. Supercritical fluids can have solvating powers similar to organic solvents but with higher diffusivity, lower viscosity and lower surface tension. The lower viscosity allows higher flow rates compared with HPLC. The solvating power can be adjusted by changing the pressure. Any solute soluble in methanol or a less polar organic solvent will elute in SFC.

Packed column SFC is based on HPLC instrumentation and columns. The mobile phase is kept supercritical by an electronically controlled variable pressure restrictor positioned after the detector.

Advantages of SFC

- **Faster diffusion of mobile phase.** This leads to higher speed and throughput enabling more samples per day to be run. Typically SFC will allow a fivefold improvement in throughput and also saves time in post-chromatographic processing.
- **Lower viscosity of mobile phase.** The lower pressure drop enables higher flow rates or longer columns to be used.
- **Improved chromatographic resolution** will give better analyses and high yield and purity during purification.

Preparative SFC

SFC is an ideal preparative chromatography technique due to the speed of analysis and the vaporization at the end of the preparative process, which reduces solvent removal costs.

Chiral SFC

SFC has been shown to be particularly useful for chiral analyses and is used in enantioselective phase screening, followed by optimisation of separation conditions on the chosen column. This leads on to preparative purification of a drug in mg to kg quantities. Daicel and Regis chiral columns have been extensively used for SFC and preparative scale-up. Please contact us for further details on any of these column ranges.

Achiral SFC

For achiral SFC analyses normal-phase materials are generally used, typically silica, cyano and diol (see pages 45, 42 and 43 respectively for a selection of suitable columns). More recently, specialised bonded phases for SFC, including 2-Ethylpyridine, Pyridylamide and many others have been developed. Figure 2 shows the SFC separation of non-steroidal anti-inflammatories on a COSMOSIL 3-Hydroxyphenyl column. Column ranges specifically designed for achiral SFC can be found on the following pages:

COSMOSIL from Nacalai Tesque – see p.79

GreenSep from ES Industries – see p.85

PrincetonSFC from Princeton Chromatography – see p.131-133

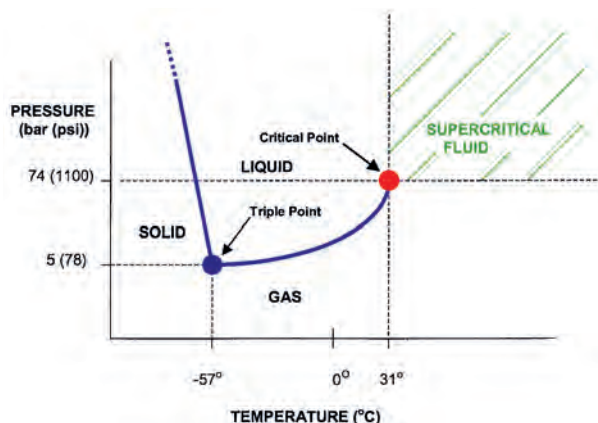

Figure 1. CO₂ Phase Diagram

Column: COSMOSIL 3-Hydroxyphenyl (5µm, 150 x 4.6mm)
 Eluent: CO₂ – CH₃OH (95:5 to 65:35 over 6 mins)
 Flow rate: 5ml/min
 Temperature: 30°C
 Detection: UV, 230nm

1. Ibuprofen
2. Fenoprofen
3. Flurbiprofen
4. Ketoprofen
5. Indoprofen

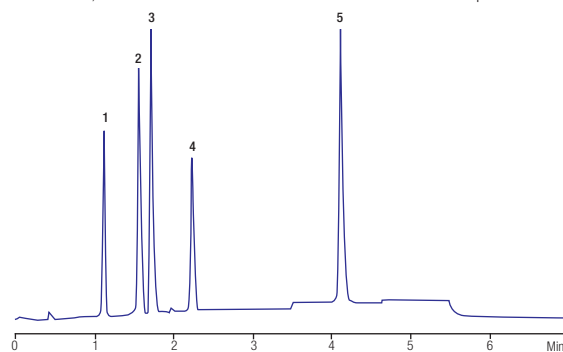

Figure 2. SFC separation of anti-inflammatory drugs

CAPILLARY ELECTROPHORESIS (CE)

Separation in capillary electrophoresis (CE) is achieved by the differential migration of solutes in a narrow fused silica capillary by the application of an electric field. The technique developed from a combination of various electrophoresis and chromatographic techniques. The separation mechanism is mainly based on differences in solute size and charge at a given pH. Different modes of capillary electrophoretic separations can be performed using a standard CE instrument.

CE Instrumentation

Figure 1 shows a simplified schematic diagram of a typical CE instrument. This consists of a high voltage power supply, two buffer reservoirs, a capillary, detector and output device. Each side of the high voltage power supply is connected to an electrode. The capillary is made of fused silica (typically 25 - 75 μm i.d. and 0.5 to 1.5m in length) and is usually coated externally with polyimide. Each end of the capillary is dipped in a vial containing the electrode and aqueous buffer. For UV detection, the capillary has a small window near the cathodic end which allows UV-VIS light to pass through the analyte and measure absorbance. Capillaries used for MS detection do not require this window. Other common detection modes include MS and fluorescence.

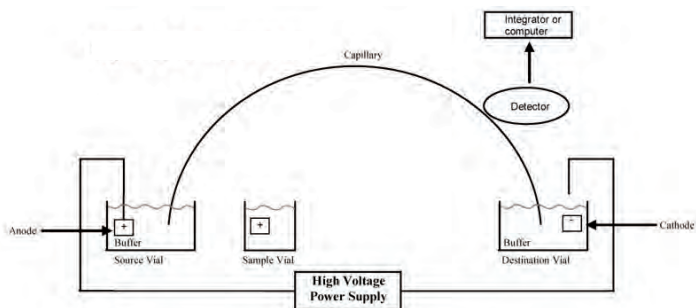

Figure 1. CE instrumentation

Principle

CE separates ions according to their electrophoretic mobility, which takes into account the charge and hydrodynamic size of the molecule and eluent viscosity. The actual migration of an ion is also affected by the level of voltage applied. The most important parameter in CE is the electro-osmotic flow (EOF) which is the bulk flow of liquid in the capillary as a consequence of the surface charge on the interior capillary wall. EOF forms the mobile phase 'pump'. An unbonded fused silica capillary (at $\text{pH} > 3$) contains deprotonated silanol (SiO^-) ions on the interior surface. The capillary wall then develops a double layer of cations attracted to it. The inner cation layer is stationary, whilst the diffuse outer layer can move along the capillary. Under the applied electric field, the cations move towards the cathode, creating a bulk flow, due to the EOF. Anions in solution, although attracted to the anode, get swept along to the cathode as well. In general, cations will separate first, followed by neutrals and then anions. By chemically coating the internal surface of the fused silica tubing by cationic groups (e.g. surfactant), the direction of flow is reversed and is independent of pH.

CE vs HPLC

- CE has a flat flow profile due to the EOF, which does not contribute significantly to band broadening and results in narrower peaks. HPLC has a parabolically shaped pressure-driven flow profile (see Figure 2).
- CE has greater peak capacity compared with HPLC
- HPLC has more complex instrumentation
- CE requires smaller injection volumes, typically 1-50nl
- HPLC has a wider range of column lengths and packing materials

Applications

Typical applications of CE include the analysis of proteins, peptides, amino acids, nucleic acids, inorganic ions, organic bases and organic acids.

Figure 3 shows the separation of inorganic ions on a Funcap-CE/Type A capillary.

A selection of capillaries and accessories for CE is offered by the following manufacturers:

GL Sciences (Funcap) – see p.174

MicroSolv (Simplus, Celerity etc) – see p.174

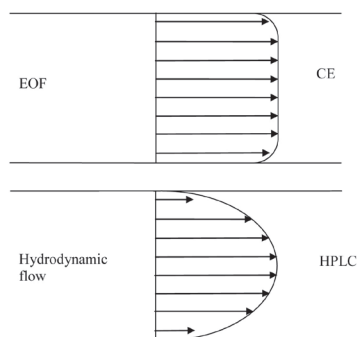

Figure 2. Comparison of CE and HPLC flow profiles

Capillary: Funcap-CE/Type A (64.5cm x 50 μm)
 Effective length 56cm
 Buffer: 20mM Na_2SO_4
 20mM acetate buffer, pH 6.1
 Voltage: -15kV
 Temperature: 18°C
 Detection: UV 210nm

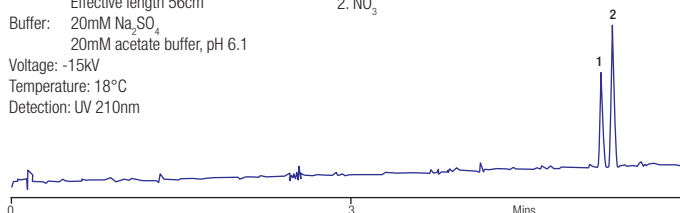

Figure 3. Analysis of inorganic ions

Base Material

- **Silica** is the most popular base material. It has a high physical strength and a surface which is easily chemically modified to give phases suitable for use in a broad range of HPLC modes. However, silica dissolves in water at pH ≥ 6.5 , whilst bonded silicas are prone to be unstable at pH ≤ 2.5 . Newer bonded silicas may have an extended pH range of 2 -10 or higher. More recent innovations include the TYPE-C™ Silica range in which the silica surface is modified with a layer of silicon hydride (see page 115 for further details).
- **Polymeric** materials have minimal pH restrictions but are less physically stable and exhibit lower separation efficiencies than silica for small molecules. For large molecules such as proteins or synthetic polymers, their performance is comparable to that of silica based materials.
- **Graphitised carbon** has high strength and excellent pH stability but cannot be modified. It can be expensive and is best used in unique selectivity applications (see page 150).
- **Zirconia** (ZrO_2) has the advantage of unique selectivity combined with extreme chemical and thermal stability (up to 200°C) (see pages 162-164).
- **Titania** (TiO_2) is stable over a wide pH range and at elevated temperatures. In contrast to silica, the surface of titania is alkaline, which can be beneficial in the analysis of basic drugs, but separation efficiencies are generally lower (see pages 89 and 163).
- **Alumina** has greater pH stability than silica but cannot be easily chemically modified (see pages 85 and 110).

Separation Mode

In simple terms, selection of the appropriate chromatographic separation mode is guided by the solute's molecular size and polarity. An outline selection guide is given below. For some molecules more than one technique may be appropriate.

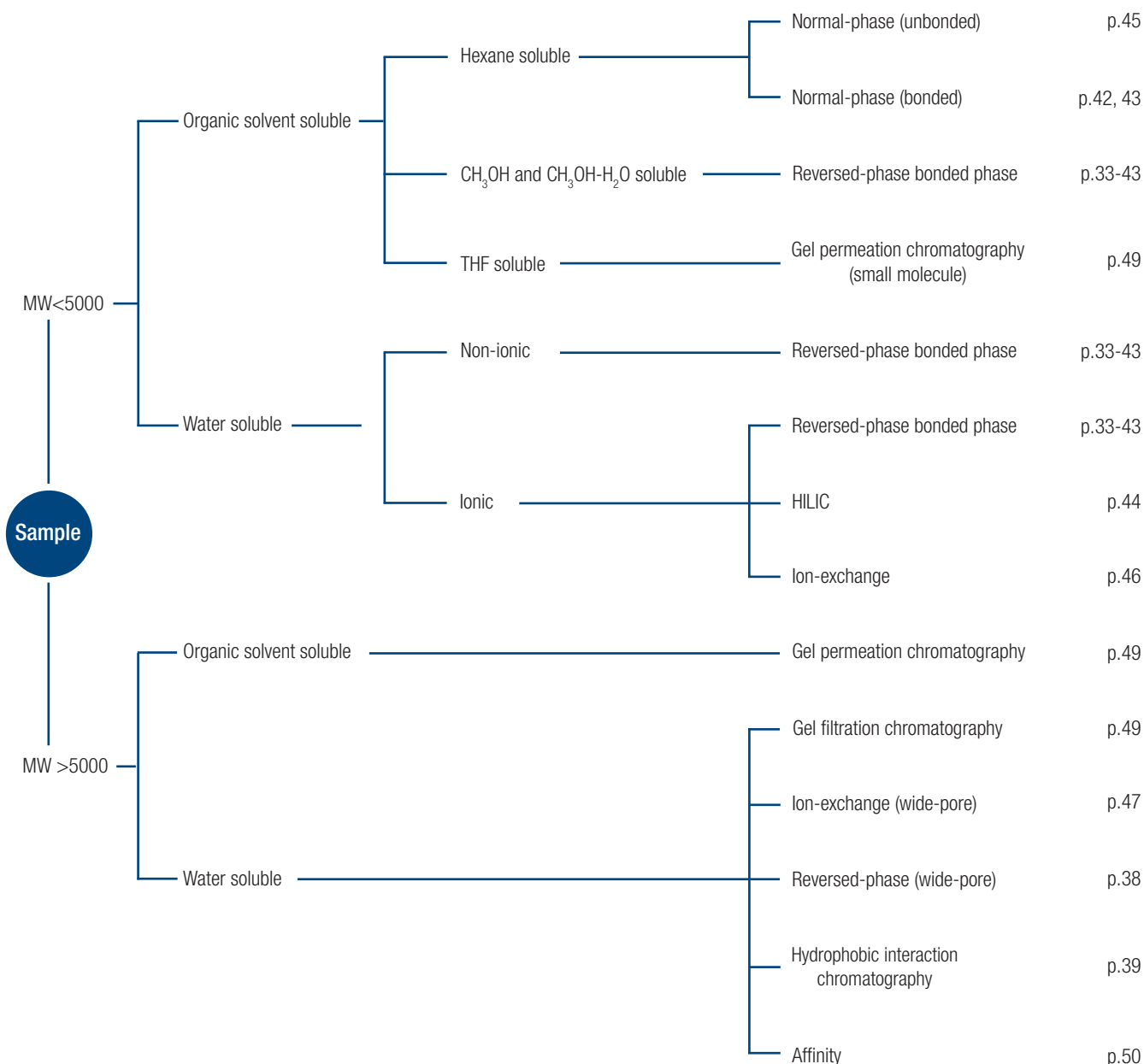

Selectivity is the most powerful tool for modifying solute resolution. Different bonded phases for reversed-phase separations will exhibit different combinations of possible solute-stationary phase interactions. For any given bonded phase, a combination of separation mechanisms will influence the overall selectivity of the phase. The predominance of each mechanism will also depend on the properties of the analyte and the chromatographic conditions applied. The most significant interactions between solute and stationary phase contributing towards column selectivity are summarised below.

- **Hydrophobic interaction** is a dominant retention mechanism for all reversed-phase columns and the most significant interaction of alkyl phases. For a given phase, retention time is proportional to the hydrophobicity of the molecule.
- **Hydrogen-bonding capacity** of a phase generally involves the interaction of a basic solute group with an acidic group within the stationary phase, possibly from unbonded silanol groups.
- **π - π interactions** are observed between an aromatic or unsaturated solute and an aromatic stationary phase.
- **Steric selectivity** is a measure of the accessibility of solutes to the stationary phase. Larger solute molecules may be excluded from the stationary phase.
- **Dipole-dipole interactions**, between a dipolar solute group and a dipolar group in the stationary phase, are most important in the case of cyano and PFP bonded columns.
- **Cation-exchange interactions** may occur between a cationic solute and an ionised silanol within the stationary phase.

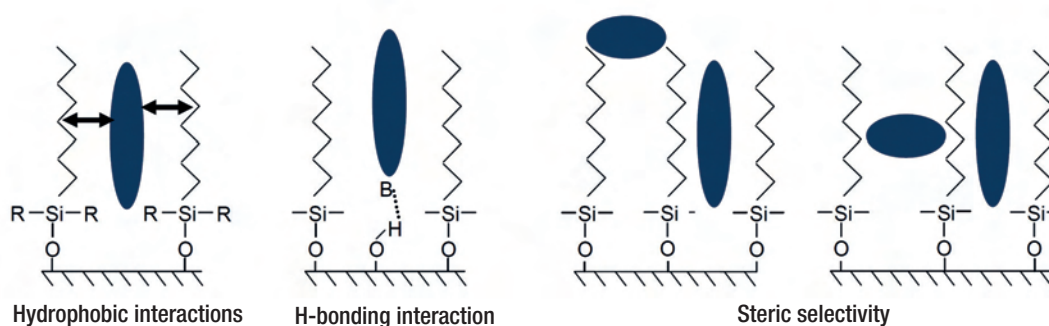

A general summary of these interactions for typical reversed-phase bonded phases is given below. Different interactions may be dominant for different analytes and interaction strengths will vary amongst different manufacturers' bonded phases. However, this table gives a useful indication of likely interaction strengths.

Bonded Phase	USP Listing	Hydrophobic	H-Bonding	π - π	Steric	Dipole-dipole	Cation-exchange
C18 ¹	L1	Very strong	Weak	No	Weak	No	Weak
C8	L7	Strong	Weak	No	Weak	No	Weak
C4	L26	Weak	Weak	No	Weak	No	Weak
Phenyl	L11	Strong	Weak	Strong donor	Moderate	Weak	Weak
PFP	L43	Moderate	Moderate	Strong acceptor	Moderate	Strong	Moderate
Cyano	L10	Weak	Weak	Weak	Weak	Strong	Weak

¹ For new generation high purity type B phases. Properties may vary for older generation type A phases

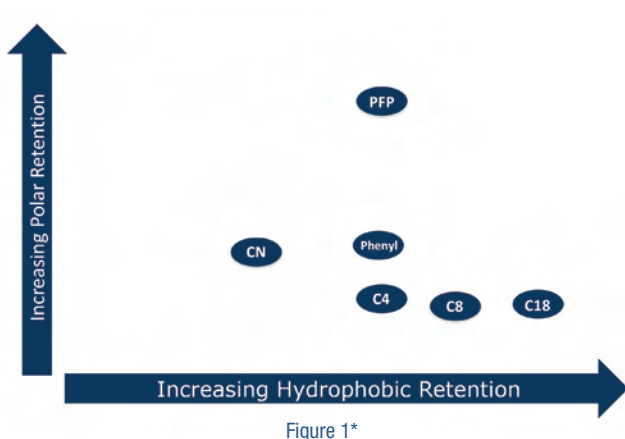

Figure 1*

Figure 1 shows a schematic representation of the relative selectivity expected of typical bonded phases with regards to hydrophobic and polar retention for specific test probes. This may not be representative of all phases in each category and for all analytes, but gives a useful general guideline.

* Based on the PQRI database (<http://www.usp.org/app/USPNF/columnsDB.html>)
Plot of hydrophobicity (H) and cation exchange capacity at pH 7 (C @ pH 7.0)

Hydrophobicity is the primary mechanism of analyte interaction with C18 and other alkyl-bonded stationary phases (see page 30). In addition, the polarity of the phase will also contribute to the overall selectivity observed.

Hydrophobicity

The strength of hydrophobic interaction can be measured by the retention of neutral (non-polar) molecules. The k values (retention factors) for a neutral species, for a given C18 phase, will give an indication of the surface area and surface coverage (ligand density) of the silica.

The percentage of carbon in the material is a simplistic but useful guide to the hydrophobic retention characteristics of a column. In Figure 1 this loose correlation is demonstrated by the increase in retention observed when alkyl chain length (i.e. carbon load) is increased. This increase results from an increase in hydrophobicity of the stationary phase. Similarly an increase in retention would be expected in going from a C18 phase with low carbon load to one of high carbon load.

Hydrophobic selectivity can be determined from the retention factor ratio between two neutral species. This is a better measure of surface coverage than carbon content, as surface area and porosity may vary from silica to silica.

Polarity

The second key property of C18 materials is their silanol activity, often discussed in terms of polarity. This can be determined by measuring the retention factor ratio between a basic and an acidic compound. At $\text{pH} > 7$ the total ion-exchange capacity will correspond to a measure of the total silanol activity. At acidic pH (e.g. $\text{pH} 2.7$) an indication of the acidic activity of the silanol groups can be obtained. The presence of metal ions in the base silica increases the level of silanol activity. Older generation silicas have higher and less tightly controlled levels of metal ions, and hence higher silanol activity compared to newer generation alkyl bonded phases. For this and other reasons, it is strongly recommended that new method development should be approached using newer generation higher purity silicas.

High Purity Base Deactivated Phases

Modern alkyl bonded phases have very low cumulative metal ion levels within the base silica ($< 10\text{ppm}$), resulting in the number of isolated silanol groups, and hence the polarity of the silica surface, also being reduced. Combined with more effective and reproducible bonding processes, these newer generation reversed-phase materials lead to significantly improved chromatography for the more basic polar solute molecules. Use of bonded alkyl groups containing hydrophilic substituents (i.e. polar embedded) can either enhance this effect and/or offer alternative selectivity.

Optimising Selectivity

Figure 2 illustrates the relationship between the change in polarity and hydrophobicity for typical C18, C8 and C4 materials, showing a decrease in hydrophobicity on reducing alkyl chain length. Greater ligand density, and hence lower polarity, is also seen as the length of the alkyl chain is reduced. However, changing the alkyl chain length may reduce analysis time but will not significantly affect selectivity. Changing the chemistry to an alternative bonded phase is a more powerful tool to achieve this.

Older Generation 'Traditional' Phases

The older 'traditional' C18 phases are hydrophobic and have a high polarity due to the lower purity silica containing a higher level of acidic silanol groups on which they are based. Use of the newer high purity silicas reduces the resultant phases' silanol activity and improves reproducibility. Employing a polar embedded functionality may also result in a reduced polarity material. For basic solutes that will interact strongly with surface silanols, lower polarity phases are generally recommended. However, for certain analyses, the additional interactions provided by the surface silanols of a 'traditional' C18 material may be beneficial to the overall separation.

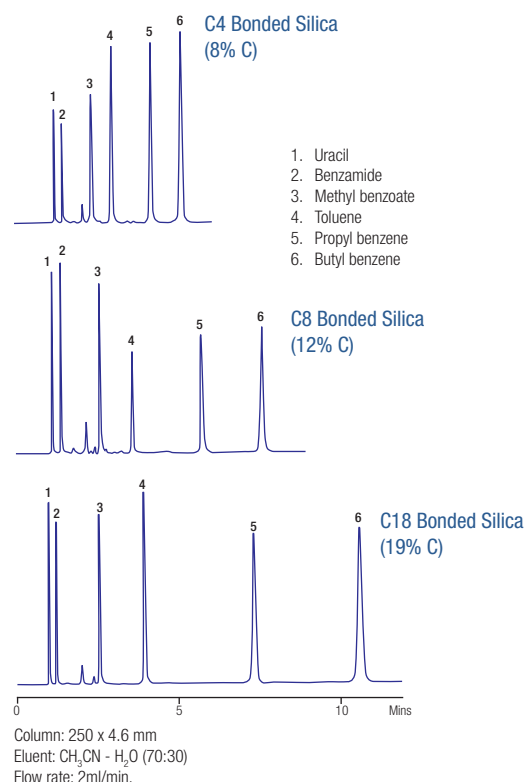

Figure 1. Increase in retention with alkyl chain length

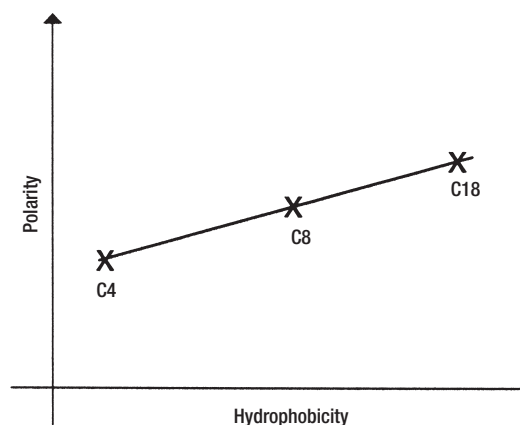
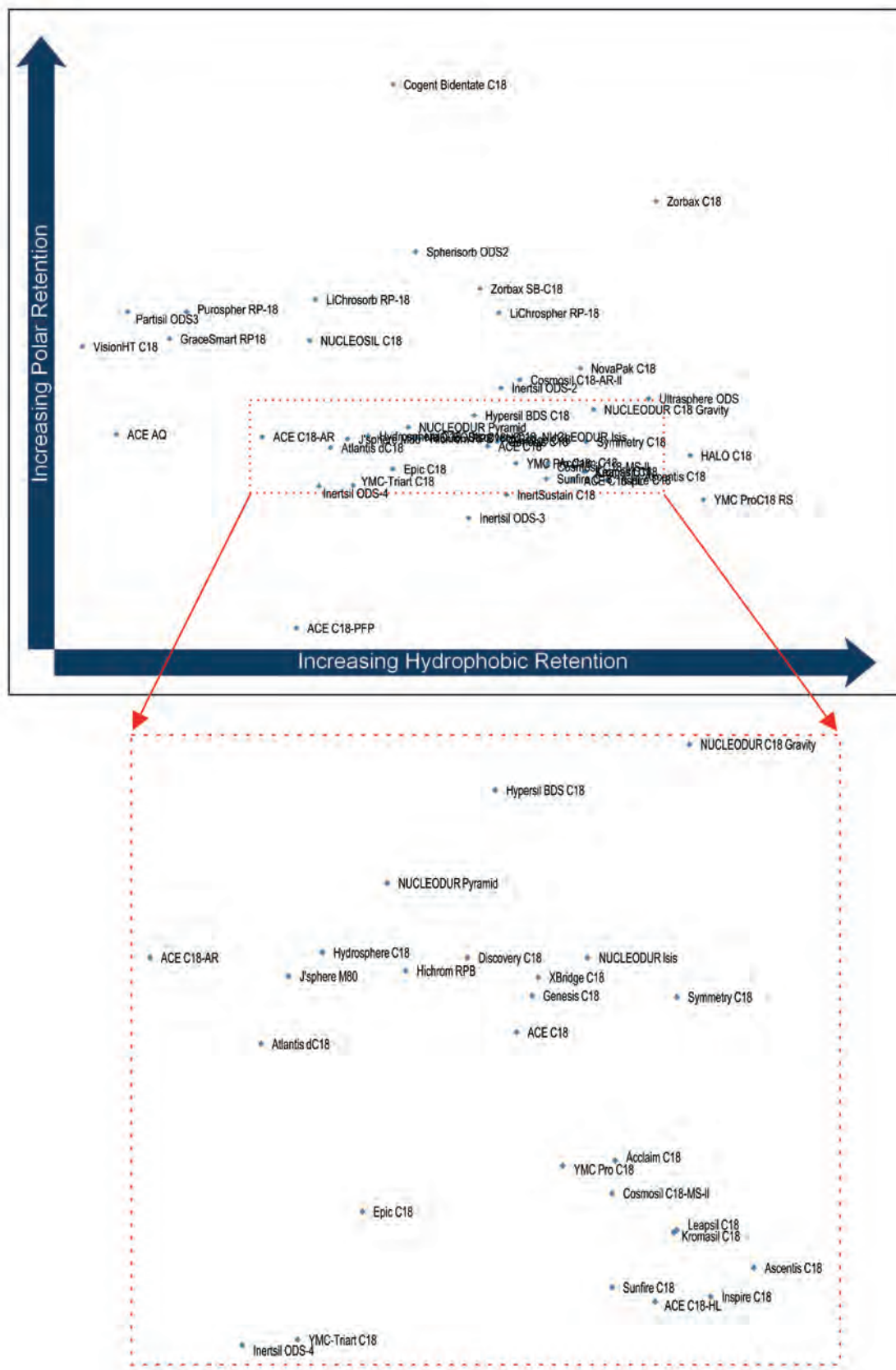

Figure 2. Variation of phase polarity with change in hydrophobicity

Characterisation of C18 Phases (continued)

Figure 3 is a plot showing the relative selectivity comparison for a number of C18 bonded columns, in which the hydrophobicity is plotted versus increasing polar retention.



*Based on the PQRI database (<http://www.usp.org/app/USPNF/columnsDB.html>)
Plot of hydrophobicity (H) and cation exchange capacity at pH 7 (C @ pH 7.0)

Figure 3*

Octadecyl (ODS) or C18 bonded phases are the most widely used reversed-phase materials. Table 1 lists the physical characteristics of a range of C18 bonded small pore silica phases.

Table 1. Octadecylsilyl-bonded silica phases

Phase	Particle Size (µm)	Pore Size (Å)	Surface Area (m ² /g)	Carbon Load (%)	Endcapped	Page
Acclaim C18	2.2, 3, 5	120	300	18	Yes	152
Accucore C18 ¹	2.6	80	130	9	Yes	149
Accucore XL C18 ¹	4	80	90	7	Yes	149
ACE C18 ²	2, 3, 5, 10	100	300	15.5	Yes	58, 71, 72
ACE C18-HL	3, 5, 10, 15	90	400	20	Yes	58, 64, 71, 72
ACE C18-AR ²	2, 3, 5, 10	100	300	15.5	Yes	58, 60, 71, 72
ACE C18-PFP ²	2, 3, 5, 10	100	300	14.3	Yes	58, 61, 71, 72
ACE SuperC18 ^{2,4}	2, 3, 5, 10	90	400	14.8	Yes	58, 59, 71, 72
Brownlee Spheri RP-18	5, 10	80	180	11	Yes	126
Brownlee Spheri ODS	5	80	180	14	Yes	126
Brownlee SPP C18 ¹	2.7	90	150	8	Yes	-
CAPCELL PAK ACR	3, 5	80	340	18	Yes	-
CAPCELL PAK AG C18	5	120	300	15	Yes	-
CAPCELL PAK MG III C18	3, 5	100	260	15	Yes	-
CAPCELL PAK SG C18	5	120	300	14	Yes	-
CAPCELL PAK UG C18	3, 5	120	300	15	Yes	-
Chromagabond BAS-C18	5	120	180	12	No	85
Chromagabond C18	5	100	300	16	No	85
Chromagabond MC-18	5	60	475	-	Yes	85
Chromolith RP-18e	-	-	300	18	Yes	110
Cogent Bidentate C18	4	100	350	16.5	No	115, 117, 120
COSMOSIL C18-AR-II	3, 5	120	300	17	Yes	76, 79
COSMOSIL C18-MS-II	3, 5	120	300	16	Yes	76, 79
Develosil ODS-UG	3, 5	140	300	18	Yes	80, 81
Develosil ODS-MG	3, 5	100	450	15	Yes	80, 81
Develosil ODS-HG	3, 5	140	300	18	Yes	80, 81
Develosil ODS-SR	3, 5	80	-	18	Yes	80, 81
Endeavorsil C18	1.8	120	300	20	Yes	82, 83
Epic C18	1.8, 3, 5, 10	120	230	18	Yes	85
Epic C18-MS	1.8, 3, 5, 10	120	350	22	Yes	85
Epic C18-SD	1.8, 3, 5, 10	120	350	24	Yes	85
Exsil ODS	3, 5, 10	100	200	11	Yes	86
Exsil ODS1	3, 5	100	200	7	No	86
Exsil ODSB	3, 5	100	200	12	Yes	86
Genesis C18	3, 4, 7	120	300	18	Yes	90
GraceSmart C18	3, 5	120	220	10	Yes	90
HALO C18 ¹	2.7	90	150	8	Yes	91
HALO-5 C18 ¹	5	90	90	5.5	Yes	91
HALO Peptide ES-C18 ¹	2.7	160	80	4.6	Yes	91
HECTOR-M C18	3, 5, 10	100	320	17	Yes	2
Hichrom C18	3.5, 5	150	250	15	Yes	92-96
Hichrom RPB ³	3.5, 5, 10	110	340	14	Yes	97, 98
Hydrosphere C18	2, 3, 5	120	340	12	Yes	-
Hypersil ODS	3, 5	120	170	10	Yes	151
Hypersil BDS C18	2.4, 3, 5	130	170	7	Yes	151
Inertsil ODS	5	100	350	14	Yes	88
Inertsil ODS-2	5	150	320	18.5	Yes	88, 89
Inertsil ODS-3	2, 3, 4, 5	100	450	15	Yes	87, 88
Inertsil ODS-4	2, 3, 5	100	450	11	Yes	87
Inertsil ODS-P	3, 5	100	450	29	No	87
Inertsil Peptide C18	5	100	450	15	Yes	87
Inertsil ODS-Sprint	3, 5	100	450	8.5	Yes	87
Inertsil Sulfa C18	3, 5	100	450	15	Yes	87
InertSustain C18	2, 3, 5	100	350	14	Yes	87
Inspire C18	3, 5, 10	100	440	27	Yes	-
Kromasil C18	2.5, 3.5, 5, 10	100	320	20	Yes	-
Kromasil Eternity C18	2.5, 5	100	330	14	Yes	-
L-column ODS	3, 5	120	340	17	Yes	101
L-column2 ODS	2, 3, 5	120	340	17	Yes	101

¹ Superficially porous phase

² UHPLC compatible columns available as ACE Excel

³ Mixed alkyl mode C18/C8

⁴ Superficially porous 2.5µm and 5µm also available

Specifications of C18 Bonded RP Materials (continued)

Table 1. Octadecylsilyl-bonded silicas (continued)

Phase	Particle Size (µm)	Pore Size (Å)	Surface Area (m ² /g)	Carbon Load (%)	Endcapped	Page
Leapsil C18	2.7	100	440	27	Yes	82, 83
LiChrosorb RP-18	5, 10	100	300	16.2	No	111
LiChrospher RP-18	5	100	350	21.0	No	112, 113
LiChrospher RP-18e	5	100	350	21.6	Yes	112, 113
NUCLEODUR C18 Gravity	1.8, 3, 5	110	340	18	Yes	102
NUCLEODUR C18 ec	3, 5	110	340	17.5	Yes	102
NUCLEODUR C18 Isis	1.8, 3, 5	110	340	20	Yes	102
NUCLEODUR C18 PAH	1.8, 3	110	340	proprietary	Yes	102
NUCLEODUR C18 HTec	1.8, 3, 5, 7, 10	110	340	18	Yes	102
NUCLEOSHELL RP 18 ¹	2.7	90	130	7.5	Yes	102
NUCLEOSIL C18	3, 5, 7, 10	100	350	15	Yes	103, 104
NUCLEOSIL C18	3, 5, 7, 10	120	200	11	Yes	103, 105
NUCLEOSIL C18 AB	5	100	350	25	Yes	103, 104
NUCLEOSIL C18 HD	3, 5	100	-	20	Yes	-
Partisil ODS	10	-	-	-	-	121-125
Partisil ODS2	10	-	-	-	-	121-125
Partisil ODS3	5, 10	-	-	-	-	121-125
Partisphere C18	5	-	-	-	-	122, 123
PrincetonSPHER C18	3, 5, 10	60, 100	500, 325	23, 19	Yes	134, 135
Purospher RP-18	5	90	500	18.5	Yes	110
Purospher RP-18e	5	120	350	18	Yes	110
Purospher STAR RP-18e	2, 3, 5	120	330	17	Yes	110
Spursil C18	3, 5, 10	100	440	25	Yes	82, 83
Spursil C18-EP	3, 5, 10	100	440	24	Yes	82, 83
Symmetry C18	3.5, 5	100	335	19	Yes	-
Synchronis C18	1.7, 3, 5	100	320	16	Yes	151
TSKgel ODS-140HTP	2.3	140	-	8	Yes	154
TSKgel ODS-100V	3, 5	100	-	15	Yes	154
TSKgel ODS-100Z	3, 5	100	-	20	Yes	154
TSKgel ODS-80T _M	5, 10	80	-	15	Yes	-
TSKgel ODS-80T _S	5, 10	80	-	15	Yes	-
TSKgel Super-ODS	2.3	110	-	8	Yes	154
TSKgel ODS-120T	5, 10	120	-	22	Yes	-
TSKgel ODS-120A	5, 10	120	-	20	Yes	-
Ultrasphere ODS	3, 5	80	-	-	Yes	156, 157
Vydac Denali	3, 5, 10	120	-	20	Yes	-
Waters µBondapak C18	10	125	330	10	Yes	-
Waters Nova-Pak C18	4	60	120	7	Yes	-
Waters Spherisorb ODS1	3, 5, 10	80	220	6.2	No	160, 161
Waters Spherisorb ODS2	3, 5, 10	80	220	11.5	Yes	160, 161
Waters Spherisorb ODSB	5	80	220	11.5	Yes	160, 161
YMC J-sphere ODS-L80	4	80	510	9	Yes	-
YMC J-sphere ODS-M80	4	80	510	14	Yes	-
YMC J-sphere ODS-H80	4	80	510	22	Yes	-
YMC ODS-A	3, 5	120	330	17	Yes	-
YMC ODS-AL	3, 5	120	330	17	No	-
YMC ODS-AM	3, 5	120	330	17	Yes	-
YMC ODS-AQ	3, 5	120	330	14	Yes	-
YMC ProC18	2, 3, 5	120	330	17	Yes	-
YMC ProC18RS	3, 5	80	510	22	Yes	-
YMC-Triart C18	1.9, 3, 5	120	-	16	Yes	-
ZORBAX ODS	5	70	330	20	Yes	165, 166
ZORBAX SB-C18	1.8, 3.5, 5, 7	80	180	10	No	-
ZORBAX Extend-C18	1.8, 3.5, 5	80	180	12.5	Yes	-
ZORBAX Eclipse XDB-C18	1.8, 3.5, 5	80	180	10	Yes	-
ZORBAX Eclipse Plus C18	1.8, 3.5, 5	95	160	8	Yes	-

¹ Superficially porous phase

SPECIFICATIONS OF C1 TO C8 & C30 BONDED REVERSED-PHASE MATERIALS

Octyl-bonded phases are the most common medium polarity alternative to C18 bonded phases. Very short chain alkyl-bonded phases are less stable. The shorter the alkyl chain the greater the vulnerability of the material to aqueous dissolution at high pH or loss of bonded phase at low pH. For wide pore silicas the C4 chemistry retains high popularity. Table 1 lists the physical characteristics of a range of C1 to C8 bonded and C30 bonded narrow pore silica phases. For wide pore (300Å) phases see page 38.

Table 1. Short chain alkyl (C1 to C8) and C30 bonded silica phases

Phase	Particle Size (µm)	Pore Size (Å)	Surface Area (m ² /g)	Carbon Load (%)	Endcapped	Page
C1 Bonded						
CAPCELL PAK C1 UG	5	120	300	7	No	-
Chromegabond TMS	5	60	475	-	No	-
Develosil TMS-UG	3, 5	140	300	4.5	Yes	80, 81
Exsil C1	3, 5	100	200	3	No	86
Hypersil SAS	5	120	170	2.5	No	151
Kromasil C1	5	100	320	4.7	Yes	-
ProntoSIL C1	3, 5	120	300	2	No	-
Waters Spherisorb C1	3, 5	80	220	2.2	No	160, 161
YMC TMS	3, 5	120	330	4	No	-
ZORBAX TMS	5	70	330	4	Yes	165, 166
C2 Bonded						
Chromegabond C2	5	60	480	-	No	85
NUCLEOSIL C2	7	100	350	3.5	No	103, 104
C3 Bonded						
ZORBAX SB-C3	5	80	180	4	No	-
C4 Bonded						
ACE C4	2 ² , 3, 5, 10	100	300	5.5	Yes	58, 71, 72
Epic C4-SD	1.8, 3, 5, 10	120	350	8	Yes	85
HECTOR-M C4	3, 5, 10	100	320	3	Yes	2
Inertsil C4	5	150	320	7.5	Yes	88, 89
Kromasil C4	2.5, 3.5, 5, 7, 10	100	320	8	Yes	-
PrincetonSPHER C4	3, 5, 10	60, 100	500, 325	8, 6	No	134, 135
ProntoSIL C4	3, 5	120	300	4	No	-
YMC C4	3, 5	120	330	7	Yes	-
YMC ProC4	3, 5	120	340	7	Yes	-
C6 Bonded						
Chromegabond C6	5	60	220	6	No	85
Chromegabond MC-CC6	5	60	475	7	Yes	-
PrincetonSPHER C6	3, 5, 10	60, 100	500, 325	10, 8	Yes	134, 135
Waters Spherisorb C6	3, 5	80	220	4.7	Yes	160, 161
C8 Bonded						
Acclaim C8	2.2, 3, 5	120	300	11	Yes	152
Accucore C8 ¹	2.6	80	130	5	Yes	149
ACE C8	2 ² , 3, 5, 10	100	300	9.0	Yes	58, 71, 72
AquaSep	3, 5	100	450	16	-	85
Brownlee Spheri RP-8	5, 10	80	180	6	Yes	126
Brownlee SPP ¹	2.7	90	150	7.7	Yes	-
CAPCELL PAK C8 UG	5	120	300	10	Yes	-
CAPCELL PAK C8 AG	5	120	300	10	Yes	-
CAPCELL PAK C8 DD	5	80	300	11	Yes	-
CAPCELL PAK C8 SG	5	120	300	10	Yes	-
Chromegabond BAS-C8	5	100	300	8	No	-
Chromegabond C8	5	100	300	8	No	85
Chromegabond C8-BD	5	100	475	12	No	-
Chromolith RP-8e	-	-	300	11	Yes	110
Cogent Bidentate C8	4	100	350	7	No	115, 117, 120
Develosil UG C8	5	140	300	11	Yes	80, 81
Epic C8	1.8, 3, 5, 10	120	230	10	Yes	85
Exsil C8	3, 5	100	200	6	Yes	86
Genesis C8	3, 4, 7	120	300	11	No	90
Genesis C8 e/c	3, 4, 7	120	300	11	Yes	90
HALO C8 ¹	2.7	90	150	5.4	Yes	91
HALO-5 C8 ¹	5	90	90	3.7	Yes	91
HECTOR-M C8	3, 5, 10	100	320	10	Yes	2

¹ Superficially porous phases

² As ACE Excel column

Specifications of C1 to C8 & C30 Bonded Reversed-Phase Materials (continued)

Table 1. Short chain alkyl (C1 to C8) and C30 bonded silica phases (continued)

Phase	Particle Size (µm)	Pore Size (Å)	Surface Area (m ² /g)	Carbon Load (%)	Endcapped	Page
C8 Bonded						
Hichrom C8	3.5, 5	150	250	8	Yes	92-96
Hypersil MOS	3, 5	120	170	6.5	No	151
Hypersil MOS-2	5	120	170	6.5	Yes	151
Hypersil BDS C8	2.4, 3, 5	130	170	11	Yes	151
Hypersil GOLD C8	1.9, 3, 5	175	220	8	Yes	150
Inertsil C8	5	150	320	10.5	Yes	88
Inertsil C8-3	2, 3, 5	100	450	9	Yes	87, 88
Inertsil C8-4	2, 3, 5	100	450	5	Yes	87
InertSustain C8	2, 3, 5	100	350	8	Yes	87
Inspire C8	3, 5, 10	100	440	17	Yes	82, 83
Kromasil C8	2.5, 3.5, 5, 10	100	320	12	Yes	-
L-column C8	5	120	340	10	Yes	101
L-column2 C8	5	120	340	10	Yes	101
LiChrosorb RP-8	5, 10	100	300	9.5	No	111
LiChrospher RP-8	5	100	350	12.5	No	112, 113
LiChrospher RP-8e	5	100	350	13	Yes	112, 113
Nova-Pak C8	4	60	120	4	Yes	-
NUCLEODUR C8 Gravity	1.8, 5	110	340	11	Yes	102
NUCLEODUR C8 ec	3, 5	110	340	10.5	Yes	102
NUCLEOSIL C8	5, 7, 10	100	350	8.5	No	103, 104
NUCLEOSIL C8	3, 5, 7, 10	120	200	6.5	No	103, 105
NUCLEOSIL C8 HD	5	100	-	13	Yes	-
Partisil C8	5, 10	-	-	-	-	121-125
Partisphere C8	5	-	-	-	-	122, 123
PrincetonSPHER C8	3, 5, 10	60, 100	500, 325	15, 11	Yes	134, 135
Symmetry C8	3.5, 5	100	335	12	Yes	-
Synchronis C8	1.7, 3, 5	100	320	10	Yes	151
TSKgel Octyl-80Ts	5	80	-	11	Yes	-
TSKgel Super-Octyl	2.3	110	-	5	Yes	154
Ultrasphere C8	3, 5	80	-	-	Yes	156, 157
Waters Spherisorb C8	3, 5, 10	80	220	5.8	Yes	160, 161
YMC Basic	3, 5	proprietary	proprietary	8	Yes	-
YMC C8	3, 5	120	330	10	Yes	-
YMC ProC8	3, 5	120	340	10	Yes	-
YMC-Triart C8	1.9, 3, 5	120	-	7	Yes	-
ZORBAX C8	5	70	330	12	Yes	165, 166
ZORBAX Eclipse Plus C8	1.8, 3.5, 5	95	160	7	Yes	-
ZORBAX Eclipse XDB-C8	1.8, 3.5, 5	80	180	7.6	Yes	-
ZORBAX Rx-C8	5	80	180	5.5	No	-
ZORBAX SB-C8	1.8, 3.5, 5	80	180	5.5	No	-
C30 Bonded						
Acclaim C30	3, 5	200	200	13	Yes	152
Accucore C30 ¹	2.6	150	80	5	Yes	149
Cogent C30 ²	3, 5	200	-	18	No	119
Develosil RPAQUEOUS	3, 5	140	300	18	Yes	80, 81
Develosil RPAQUEOUS-AR	3, 5	140	300	18	Yes	80, 81
Develosil XG-C30	3, 5	140	300	19.5	Yes	80, 81
ProntoSil C30	3, 5, 10	200	200	20	No	-
PrincetonSPHER C30 ²	3, 5, 10	200	200	19	No	134, 135
YMC Carotenoid	3, 5	proprietary	proprietary	-	-	-

¹ Superficially porous phases

² C27 phase also available

Introduction

When separating very polar, water-soluble compounds, eluents containing less than 5% organic modifier are commonly used to achieve sufficient retention. However, operation under such highly aqueous conditions can lead to poor chromatographic reproducibility and decreasing retention times. Conventional C8 and C18 phases undergo dewetting or 'phase collapse' under these conditions, resulting in a reduction of accessible bonded phase. This phenomenon may either occur very quickly or more gradually.

'High Aqueous' Phases

Approaches to address this problem include embedding a polar group in the alkyl chain or using hydrophilic (polar) endcapping reagents (see Figure 1). Both these approaches, or the use of a C30 phase, have the effect of maintaining the phase surface under fully wetted conditions, even when using 100% aqueous eluent. Polar embedded phases are also used to obtain different selectivity from conventional C18 phases.

Good Retention and Resolution for Polar Compounds

Compared to traditional alkyl phases these 'high aqueous' phases are resistant to retention loss when using highly aqueous eluents, even after several days or weeks. Reproducible retention times and improved peak shapes are achieved for acidic, basic and zwitterionic analytes.

Alternative Selectivity

Conventional C18 phases depend primarily on differing hydrophobic interactions between analytes and the stationary phase to provide separation. 'AQ' type phases may also show hydrophilic (polar) interactions via H-bonding and dipole-dipole forces. This can influence retention time and improve selectivity for polar analytes.

Eliminate Need for Ion-pair Additives

Many separations of very polar analytes are performed using ion-pair chromatography in order to provide adequate retention. The use of an 'AQ' phase generally enables reproducible results to be obtained using conventional aqueous/organic eluents.

Typical Applications

Typical applications of these 'AQ' type phases include carboxylic acids, water soluble vitamins, catecholamines, nucleic acid bases and various polar pharmaceuticals.

'AQ' Type Phases

Phase	Manufacturer	Particle Size (µm)	Pore Size (Å)	Comments	Page
Acclaim PolarAdvantage	Thermo Scientific	2.2, 3, 5	120	Embedded sulphonamide group	152
Acclaim PolarAdvantage II		2.2, 3, 5	120	Embedded amide group	152
Accucore AQ ¹		2.6	80	C18 with polar endcapping	149
Accucore Polar Premium ¹		2.6	150	Amide embedded C18	149
ACE AQ	Advanced	2 ² , 3, 5, 10	100	C18 with integral polar functionality	58, 64, 71, 72
ACE C18-Amide	Chromatography	2 ² , 3, 5, 10	100	C18 with integral amide polar group	58, 62, 71, 72
ACE C18-AR	Technologies (ACT)	2 ² , 3, 5, 10	100	C18 with integral phenyl group	58, 60, 71, 72
AquaSep	ES Industries	3, 5	100	C8 with embedded ether group	85
Chromegabond ODS-PI		3, 5	120	Ureide embedded polar group	85
CAPCELL PAK C18 AQ	Shiseido	3, 5	80	C18	-
COSMOSIL C18-PAQ	Nacalai Tesque	5	120	C18 phase with polymeric linkage	76, 79
Develosil RPAQUEOUS	Nomura	3, 5	140	C30, monofunctional	80, 81
Develosil RPAQUEOUS-AR		3, 5	140	C30, trifunctional	80, 81
Epic Polar	ES Industries	1.8, 3, 5, 10	120	Embedded ether group	85
HALO RP-Amide ¹	Advanced Materials Technology	2.7	90	Polar embedded amide	91
Hydrosphere C18	YMC	2, 3, 5	120	Hydrophilic C18 surface	-
Hypersil GOLD AQ	Thermo Scientific	1.9, 3, 5, 8	175	Alkyl chain with polar endcapping	150
Inertsil ODS-EP	GL Sciences	5	100	C18 phase with polar embedded group	87
NUCLEODUR C18 Pyramid	Macherey-Nagel	1.8, 3, 5	110	C18 with hydrophilic endcapping	102
NUCLEODUR PolarTec		1.8, 3, 5	110	Polar embedded group	102
NUCLEOSIL Nautilus		3, 5	100	C18 with polar embedded group	-
NUCLEOSIL Protect 1		5	100	Protective polar group	-
Princeton ULTIMA C18, C8 & Phenyl	Princeton Chromatography	3, 5, 10	-	Embedded polar amide functionality	134, 135
ProntoSil C18 (or C8) ace-EPS	Bischoff	3, 5	120	C18 or C8 with embedded amide group	-
ProTec-RP	ES Industries	3, 5	100	C8, C18 or Phenyl with embedded amide group	-
Spursil C18 and C18-EP	Dikma Technologies	3, 5, 10	100	C18 with proprietary polar modification	82, 83
SymmetryShield	Waters	3.5, 5	100	C18 or C8 with polar embedded group	-
Synchronis aQ	Thermo Scientific	1.7, 3, 5	100	C18 with polar endcapping	151
YMC ODS-AQ	YMC	3, 5	120	C18 with hydrophilic endcapping	-
ZORBAX Bonus-RP	Agilent Technologies	1.8, 3.5, 5	80	C14 chain with embedded amide group	-
ZORBAX SB-Aq		1.8, 3.5, 5	80	Proprietary	-

¹ Superficially porous phases

² As ACE Excel column

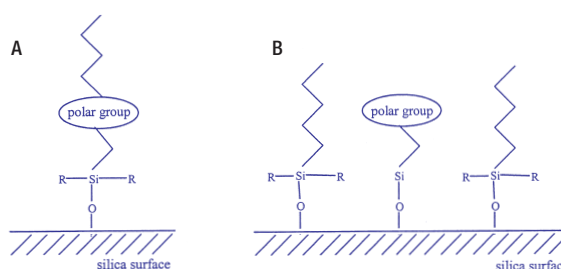

Figure 1. Polar embedded (A) and hydrophilic endcapped (B) phases

Introduction

In order for a sample molecule to freely access the interior of the pores of the packing material, its diameter must be smaller than the average pore diameter. For high molecular weight solutes, the use of lower pore size materials of 60-120Å may result in frictional drag within the pore, leading to restricted diffusion and reduced column efficiency.

The use of larger pore silica-based bonded phases therefore leads to improvements in resolution, capacity and recovery of proteins and other biomolecules, due to a reduction in size exclusion mechanism and enhanced molecular diffusion rates. A pore size of 300Å has become the accepted standard for wide pore silicas, and has been found to be suitable for a broad range of molecular weight proteins, peptides and oligonucleotides. In general, peptides exceeding approximately 50 amino acids and oligonucleotides greater than 25 residues are preferentially analysed on 300Å materials. Separations of very large biomolecules (MW >100,000Da) may require larger pore size packings (500 to 4000Å).

Bonded Phases

Alkyl-bonded silica phases are the most commonly used materials for the reversed-phase separation of biomolecules. The shorter C4 phases are generally recommended for large hydrophobic peptides and most proteins. Peptide maps, natural and synthetic peptides and small hydrophilic proteins are best chromatographed on C8 columns. C18 columns are often chosen for the analysis of small peptides. Other bonded wide pore phases, including cyano and phenyl, are available in some brands. The table below summarises a range of wide pore alkyl-bonded reversed-phase silica materials. Ion-exchange and size exclusion packings are also available as wider pore materials (please contact us for details).

Column Dimensions

Wide pore silica phases are available in a range of column dimensions from rapid analysis to preparative and process scale. Increased column capacity favours these wide pore materials for preparative separations of samples with molecular weight >5,000Da.

Separation Mechanism

In reversed-phase chromatography, proteins are retained by adsorption of the face of the protein (hydrophobic foot) to the hydrophobic surface of the packing material. The adsorption/desorption mechanism differs from that of small molecules, in that small changes in organic solvent composition can rapidly change the protein retention, thereby requiring use of shallow gradients. Proteins adsorb near the top of the column (Figure 1A) and remain adsorbed until the organic concentration reaches a high enough level for the protein to desorb (Figure 1B) and elute from the column.

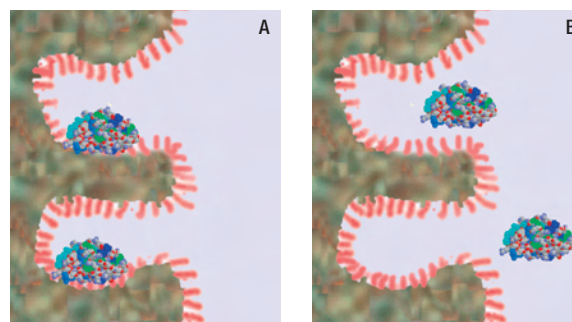

Figure 1. Adsorption and desorption of protein molecules

300Å Reversed-Phase Alkyl-Bonded Silica Phases

Phase	Manufacturer	Particle Size (µm)	Surface Area (m ² /g)	Carbon Load (%)	Page
Acclaim C18	Thermo Scientific	3	100	8	152
ACE ¹ C4-300, C8-300, C18-300	ACT	3, 5, 10	100	2.6, 5, 9	58, 67, 73
Aquapore Butyl, Octyl, ODS	Perkin Elmer	7	100	3, 5, 10	126
BioBasic 4, 8, 18	Thermo Scientific	5	100	4, 5, 9	153
Bio-Bond C4, C8, C18	Dikma Technologies	3, 5, 10	100	3, 5, 8	82, 83
Cogent Bidentate C8 300	MicroSolv	5	150	5	115, 117, 120
COSMOSIL C18-AR-300, C8-AR-300, C4-AR-300	Nacalai Tesque	5	150	12, 7, 6	79
Eprogen RP8	Eprogen	5	-	-	84
HECTOR-W C-18, C8, C4, NH ₂	RStech Corporation	3, 5, 10	-	7, 4, 3, -	2
Inertsil ¹ WP300-C4, C8, C18	GL Sciences	5	150	3, 8, 9	-
Kromasil ¹ C4, C8, C18	Akzo Nobel	5, 10, 16	110	2.9, 4.7, 8.7	-
NUCLEOSIL 300 C4, C8, C18	Macherey-Nagel	5, 7, 10	100	2, 3, 6.5	103, 106
PrincetonSPHER-300 C18, C8, C4, Phenyl, CN, NH ₂ , Diol, Silica	Princeton Chromatography	5, 10	100	-	134, 135
TSKgel Protein C4-300	Tosoh Bioscience	3	100	3	154
Vydac 201TP		3, 5, 10	-	8	90
Vydac 202TP		3, 5, 10	-	9	90
Vydac ¹ 208TP, 208MS, 214TP, 214MS, 218TP, 218MS	Grace	3, 5, 10	-	-	90
Vydac Everest C18		5, 10	-	6	90
YMC ¹ C4, C8, ODS-A	YMC	5	100	3, 4, 7	-
ZORBAX 300SB-C3, C8, C18		3.5, 5, 7	45	1.1, 1.5, 2.8	-
ZORBAX 300-Extend	Agilent Technologies	3.5, 5	45	4	-
ZORBAX Poroshell 300SB-C3, C8, C18		5	-	-	-

¹ Other wide pore bonded phases available

HYDROPHOBIC INTERACTION CHROMATOGRAPHY (HIC) PHASES

Introduction

Hydrophobic Interaction Chromatography (HIC) is a powerful technique for the separation and purification of proteins and peptides. Separations are based on the interaction between hydrophobic groups on a protein and a hydrophobic ligand on the solid support. Although the separation mechanism of HIC has similarities with that of standard reversed-phase HPLC, the density of the bonded phase ligands on the surface of the HIC packing material is much lower. HIC therefore involves weaker interactions and weaker eluents can be used. Samples are adsorbed to the HIC resin at relatively high salt concentrations and eluted by applying a linear or stepwise decreasing salt gradient. The mild conditions used in HIC typically maintain tertiary protein structure and thus biological activity (ie. no denaturation).

Selectivity

An optimum HIC separation will combine high dynamic binding capacity (DBC), adequate selectivity, good mass recovery and retention of biological activity. Proteins show varying degrees of hydrophobicity depending on their amino acid composition, structure and size. Separation can be optimised by varying the nature of the HIC phase or by varying the eluent. Very hydrophilic proteins are generally purified using highly hydrophobic stationary phases, whereas very hydrophobic proteins are separated using the least hydrophobic phases.

Method Development

In addition to the hydrophobicity of the phase ligand, several parameters affect HIC separations. These include salt type, pH, buffer concentration, temperature and gradient. Ammonium sulphate (1 or 2M) or sodium chloride (3M) salts are most commonly used for HIC applications. The pH of the salt solution will influence retention; pH 7.0 is a good starting point. Figure 1 shows the influence of pH for various salts on the DBCs of lysozyme.

Applications

Hydrophobic interaction chromatography is suitable for the separation and purification of a wide range of biomolecules. In addition to proteins, antibody fragments, RNAs, antibiotics etc. can be analysed by HIC. HIC can also be used for protein desalting. Figure 2 illustrates the separation of 16S and 23S ribosomal RNA on a TSKgel Phenyl-5PW column.

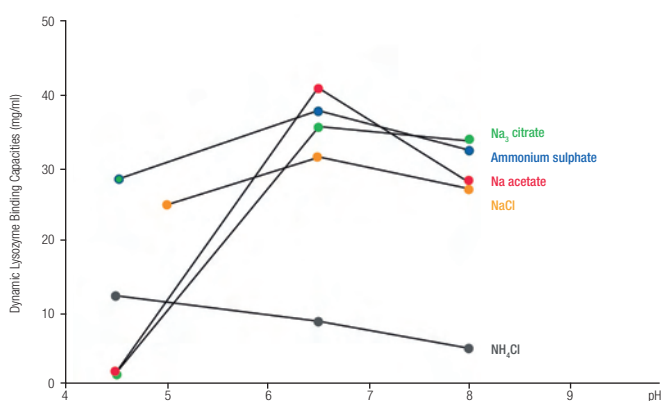
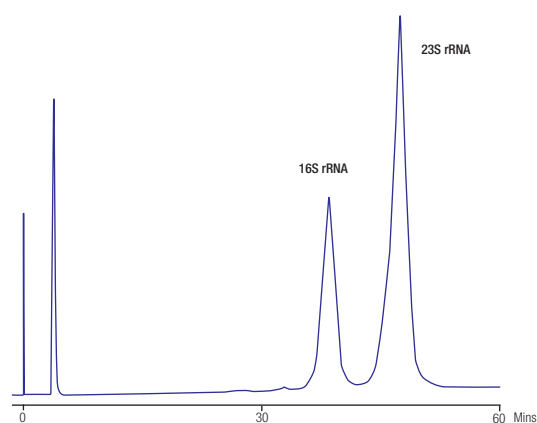

Figure 1. Influence of pH



Column: TSKgel Phenyl-5PW (75 x 7.5mm)
 Eluent: Linear gradient from 2mol/l to 0mol/l (NH₄)₂SO₄ in
 0.1mol/l phosphate buffer, pH 7.0
 Flow rate: 0.5ml/min
 Detection: UV, 280nm

Figure 2. Separation of RNAs on TSKgel Phenyl-5PW

HIC Phases

Phase	Manufacturer	Base material	Bonding	Particle Size (µm)	Pore Size (Å)	Page
COSMOSIL HIC	Nacalai Tesque	Silica	Diol	5	300	76, 79
HIC PH-814	Shodex	Polyhydroxymethacrylate	Phenyl	10	2,000	142
MCI GEL CQH Series	Mitsubishi Chemicals	Polyhydroxymethacrylate	Ether, Butyl, Phenyl	10	600	108
PolyPROPYL A			Propylaspartamide			127, 130
PolyETHYL A	PolyLC	Silica	Ethylaspartamide	3, 5, 12	300, 1000, 1500	127, 130
PolyMETHYL A			Methylaspartamide			127, 130
ProPac HIC-10	Thermo Scientific	Silica	Amide/ethyl	5	300	153
TSKgel	Tosoh Bioscience	Methacrylate	Ether, Phenyl	10, 13, 20	1,000	155
			Butyl-NPR	2.5	-	155

PHENYL BONDED PHASES

Phenyl bonded silica phases offer an alternative reversed-phase selectivity to alkyl bonded phases. They show lower hydrophobic retention than their C18 counterparts, with similar retention characteristics to C8-bonded phases. Phenyl stationary phases interact with compounds containing aromatic groups or unsaturated bonds through the involvement of π - π interactions. For aromatic solutes containing an electronegative atom or group (e.g. F, NO₂), the degree of π - π interactions with the phenyl phase will increase.

Due to the rigid nature of the phenyl ring, solute shape can also influence selectivity.

Traditional phenyl phases tend to be less stable than the corresponding C8 or C18 reversed-phases. Additionally, the larger steric size of the phenyl group reduces surface coverage, leaving a greater number of exposed silanol sites. More recently introduced phenyl phases show greater stability. The use of a purer silica base, more effective and reproducible bonding procedures and the availability of a sterically protected phenylsilane all contribute to greater phase robustness and reduced column bleed.

Conventional phenyl phases are bonded to the silica through a propyl spacer. The incorporation of the longer chain hexyl spacer results in increased hydrophobic retention and aromatic selectivity. Phenyl bonded (mainly with propyl linker) and Phenyl-Hexyl bonded phases are listed in separate tables below.

Phenyl Bonded Phases

Phase	Manufacturer	Particle Size (μm)	Pore Size (\AA)	Surface Area (m^2/g)	Page
Acclaim Phenyl-1	Thermo Scientific	3	120	300	152
Accucore Phenyl-X ¹		2.6	80	130	149
ACE C18-AR ²	Advanced Chromatography Technologies (ACT)	2 ³ , 3, 5, 10	100	300	58, 60, 71, 72
ACE Phenyl		2 ³ , 3, 5, 10	100	300	58, 71, 72
CAPCELL PAK UG Phenyl	Shiseido	5	120	300	-
Chromegabond Alkyl Phenyl	ES Industries	3, 5, 10	60, 80, 100	475, 200, 190	85
Cogent Phenyl Hydride	MicroSolv	4	100	350	115, 118, 120
Develosil Phenyl-UG	Nomura	3, 5	140	300	80, 81
Genesis Phenyl	Grace	4	120	300	90
HECTOR-M Phenyl	RStech Corporation	3, 5, 10	100	320	2
Hypersil GOLD Phenyl	Thermo Scientific	1.9, 3, 5	175	220	150
Hypersil Phenyl		5	120	170	151
Hypersil Phenyl-2		5	120	170	151
Hypersil BDS Phenyl		3, 5	130	170	151
Inertsil Phenyl	GL Sciences	5	150	320	88, 89
Inertsil Phenyl-3		2, 3, 5	100	450	87, 88
InertSustain Phenyl		3, 5	100	350	87
Kromasil Phenyl	Akzo Nobel	5, 10, 16	100	320	-
NUCLEOSIL Phenyl	Macherey-Nagel	5, 7	100, 120	350, 200	103-105
PrincetonSPHER Phenyl	Princeton Chromatography	3, 5, 10	60, 100	500, 325	134, 135
ProntoSIL Phenyl	Bischoff	3, 5	120	300	-
Synchronis Phenyl	Thermo Scientific	1.7, 3, 5	100	320	151
TSKgel Super-Phenyl	Tosoh Bioscience	2.3	110	-	154
Vydac 219MS ⁴	Grace	5	300	-	90
Waters μ Bondapak Phenyl	Waters	10	125	330	-
Waters Nova-Pak Phenyl		4	60	120	-
Waters Spherisorb Phenyl		3, 5	80	220	160, 161
YMC Phenyl	YMC	3, 5	120	330	-
YMC-Triart Phenyl		1.9, 3, 5	120	-	-
ZORBAX Phenyl		5	70	330	165, 166
ZORBAX SB-Phenyl	Agilent Technologies	3.5, 5	80	180	-
ZORBAX Eclipse XDB-Phenyl		3.5, 5	80	180	-

¹ Superficially porous phase

² C18 with integral Phenyl, classed as L1

³ As ACE Excel column

⁴ Diphenyl phase

Phenyl-Hexyl Bonded Phases

Phase	Manufacturer	Particle Size (μm)	Pore Size (\AA)	Surface Area (m^2/g)	Page
Accucore Phenyl-Hexyl ¹	Thermo Scientific	2.6	80	130	149
ACE UltraCore SuperPhenylHexyl ¹	Advanced Chromatography Technologies (ACT)	2.5, 5	95	130, 100	1
Brownlee SPP Phenyl-Hexyl ¹	Perkin Elmer	2.7	90	150	-
Epic Phenyl-Hexyl	ES Industries	1.8, 3, 5, 10	120	350	85
HALO Phenyl-Hexyl ¹	Advanced Materials Technology	2.7	90	150	91
HALO-5 Phenyl-Hexyl ¹		5	90	90	91
Kromasil Eternity Phenyl-Hexyl	Akzo Nobel	2.5, 5	100	330	-
NUCLEODUR Phenyl-Hexyl	Macherey-Nagel	1.8, 3, 5	110	340	102
NUCLEOSHELL Phenyl-Hexyl ¹		2.7	90	130	102

¹ Superficially porous phase

Fluorinated stationary phases have shown novel selectivity for several classes of compounds and in many cases have proved useful as an alternative to traditional C18 and C8 phases. In particular, pentafluorophenyl (PFP) bonded phases are becoming increasingly popular when alternative selectivity is required. Details of these PFP phases are listed on this page. For other fluorinated phases please see individual manufacturer's pages (eg. Fluophase page 151, Wakopak Fluofix page 159, PrincetonSPHER Fluoropropyl and Fluorooctyl page 135).

Separation Mechanisms

PFP-bonded phases use multiple retention mechanisms for separation of challenging compounds. These interactions include hydrophobic, π - π interaction, dipole-dipole, H-bonding and shape selectivity. The predominance of each retention mechanism will be influenced by the solute's physicochemical properties, its structure and the chromatographic conditions utilised.

The electronegative fluorine atoms produce an electron deficient phenyl ring, so that the PFP phase acts as a Lewis acid or electron acceptor. This is the opposite of phenyl phases, which contain an electron rich aromatic ring. π - π interaction can occur with solutes that are rich in electrons (Lewis bases). The carbon-fluorine bonds of the PFP ring are very polar, thus enabling analytes to also be retained by dipole-dipole and H-bonding interactions, resulting in increased analyte retention.

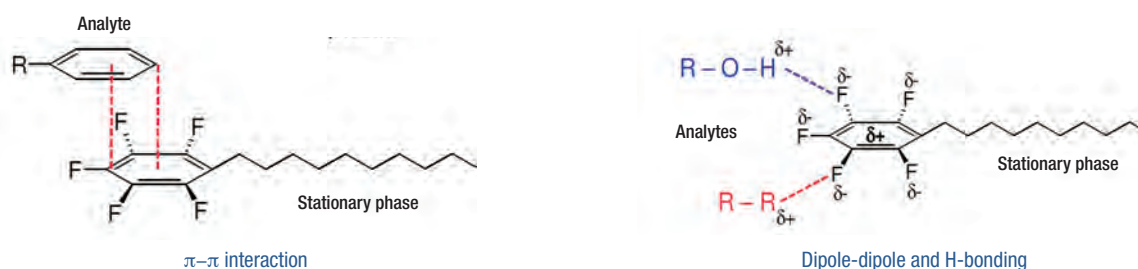

Applications

PFP phases show excellent selectivity especially for highly polar analytes, aromatic and unsaturated compounds, phenols, halogenated compounds and taxanes. In addition, positional isomers show increased separation on PFP phases.

Due to the low bleed characteristics of many of the newer PFP phases, they are ideally suited for low UV wavelength and LC-MS applications. PFP phases are generally resistant to dewetting and can be used under highly aqueous conditions.

Figure 1 illustrates the orthogonal selectivity shown by a PFP compared to a C18 phase for the separation of phenol isomers.

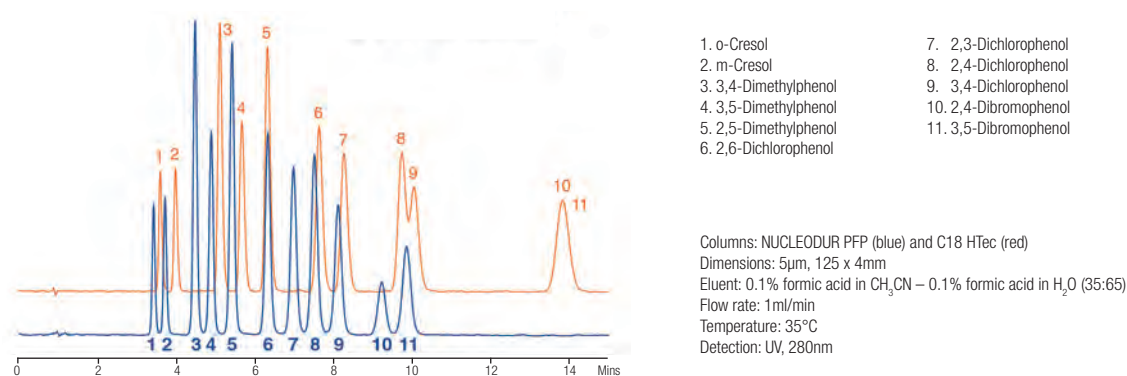

Figure 1. Separation of phenol isomers

PFP Bonded Phases

Phase	Manufacturer	Particle Size (μ m)	Pore Size (\AA)	Surface Area (m^2/g)	Page
Accucore PFP ¹	Thermo Scientific	2.6	80	130	149
ACE C18-PFP ²	ACT	2 ³ , 3, 5, 10	100	300	58, 61, 70, 71
Epic PFP-LB	ES Industries	1.8, 3, 5, 10	120	230	85
FluoroSep-RP Phenyl (FSP)		3, 5	60	350	85
HALO PFP ¹	Advanced Materials Technology	2.7	90	150	91
HALO-5 PFP ¹		5	90	90	91
Hypersil GOLD PFP	Thermo Scientific	1.9, 3, 5, 8, 12	175	220	150
NUCLEODUR PFP	Macherey-Nagel	1.8, 3, 5	110	340	102
NUCLEOSHELL PFP ¹		2.7	90	130	102
Partisphere TAC-1	Hichrom	5	-	-	122, 123
PrincetonSPHER PFP	Princeton	3, 5	60, 100	-	134, 135
YMC-Triart PFP	YMC	1.9, 3, 5	120	-	-

¹ Superficially porous phase

² C18 with integral PFP, classed as USP L1

³ As ACE Excel column

Introduction

Polar bonded silica phases offer an alternative selectivity to alkyl bonded materials (see p.31-36). In general they have a lower hydrophobicity but higher polarity. Cyano, amino and diol bonded phases can be used in both normal- and reversed-phase modes. In normal-phase they equilibrate more rapidly with the eluent than silica itself and are not deactivated by traces of water.

Availability

Cyano bonded phases show unique selectivity for polar compounds and are more suitable than bare silica for normal-phase gradient separations. The cyano functional group is a strong dipole that can interact with other dipoles or induce dipoles on solutes. These phases also exhibit moderate hydrophobicity due to the alkyl linker.

Amino bonded phases show alternative normal-phase selectivity to unbonded silica, especially for aromatics. Amino columns are also used in the HILIC mode for carbohydrate analysis and for other polar compounds. Their weak anion-exchange properties can be used in the analysis of anions and organic acids.

Diol bonded phases are a versatile alternative to unbonded silica for normal-phase separations. The hydroxyl groups provide good selectivity without excessive retention, since H-bonding with the diol layer is weaker than with silanols. Some diol bonded phases have been developed specifically for HILIC applications. Differing pore size materials are used in size-exclusion separations.

Cyano Bonded Phases

Phase	Manufacturer	Particle Size (µm)	Pore Size (Å)	Surface Area (m ² /g)	Page
ACE CN	Advanced Chromatography Technologies (ACT)	2 ¹ , 3, 5, 10	100	300	58, 71, 72
ACE CN-ES		2 ¹ , 3, 5, 10	100	300	58, 63, 71, 72
CAPCELL PAK CN UG	Shiseido	5	120	300	-
Chromegabond BAS-CN	ES Industries	3, 5, 10	120	180	85
Chromegabond CN-BD		3, 5, 10	100	475	85
Chromegabond CN-HS		3, 5, 10	60	550	85
COSMOSIL CN-MS	Nacalai Tesque	5	120	300	76
Develosil CN-UG	Nomura	5	140	300	80, 81
Develosil XG-CN		3, 5	140	300	80
Exsil CN	Grace	3, 5	100	200	86
Genesis CN		4	120	300	90
HALO ES-CN ²	Advanced Materials Technology	2.7	90	150	91
HALO-5 ES-CN ²		5	90	90	91
HECTOR-M CN	RStech Corporation	3, 5, 10	100	320	2
Hypersil GOLD CN	Thermo Scientific	1.9, 3, 5	175	220	150
Hypersil CPS		3, 5	120	170	151
Hypersil CPS-2		5	120	170	151
Hypersil BDS CPS		3, 5	130	170	151
Inertsil CN-3	GL Sciences	3, 5	100	450	87, 88
Kromasil CN	Akzo Nobel	5, 10, 16	60	540	-
LiChrosorb CN	Merck	5	100	300	111
LiChrospher CN		5	100	350	112, 113
NUCLEODUR CN and CN-RP	Macherey-Nagel	3, 5	110	340	102
NUCLEOSIL CN		5, 10	100	350	103, 104
		7	120	200	103, 105
PrincetonSPHER CN	Princeton Chromatography	3, 5, 10	60, 100	500, 325	134, 135
ProntoSIL CN	Bischoff	3, 5	120	300	-
TSKgel CN-80Ts	Tosoh Bioscience	5	80	-	-
Ultrasphere CN	Hichrom	3, 5	80	-	156, 157
Waters µBondapak CN	Waters	10	125	-	-
Waters Nova-Pak CN HP		4	60	-	-
Waters Spherisorb CN		3, 5	80	220	160, 161
YMC CN	YMC	3, 5	120	330	-
ZORBAX CN	Agilent Technologies	5	70	330	165, 166

¹ As ACE Excel column

² Superficially porous phase

Polar Bonded Phases (continued)

Amino Bonded Phases

Phase	Manufacturer	Particle Size (µm)	Pore Size (Å)	Surface Area (m ² /g)	Page
CAPCELL PAK NH ₂ UG	Shiseido	5	80	-	-
Chromegabond A/RP	ES Industries	3, 5, 10	60, 100	475, 330	-
Chromolith NH ₂	Merck	-	-	300	110
COSMOSIL NH ₂ -MS	Nacalai Tesque	5	120	300	76
Exsil NH ₂	Grace	3, 5	100	200	86
Genesis NH ₂		3	120	300	90
HECTOR-M NH ₂	RStech Corporation	3, 5, 10	100	320	2
Hypersil GOLD Amino	Thermo Scientific	1.9, 3, 5	175	220	150
Hypersil APS-2		3, 5	120	170	151
Inertsil NH ₂	GL Sciences	3, 5	100	450	87
InertSustain NH ₂		3, 5	100	350	87
Kromasil NH ₂	Akzo Nobel	3.5, 5, 7, 10	100	320	-
LiChrosorb NH ₂	Merck	5, 10	100	300	111
LiChrospher NH ₂		5	100	350	112, 113
NUCLEODUR NH ₂ and NH ₂ -RP		3, 5, 7	110	340	102
NUCLEOSIL NH ₂	Macherey-Nagel	5	100	350	103, 104
		7	120	200	103, 105
PrincetonSPHER NH ₂	Princeton Chromatography	3, 5, 10	60, 100	500, 300	134, 135
Purospher STAR NH ₂	Merck	5	120	330	110
Synchronis NH ₂	Thermo Scientific	1.7, 3, 5	100	320	151
TSKgel NH ₂ -100	Tosoh Bioscience	3	100	450	155
Waters µBondapak NH ₂	Waters	10	125	330	-
Waters Spherisorb NH ₂		3, 5, 10	80	220	160, 161
YMC NH ₂	YMC	3, 5	120	330	-
ZORBAX NH ₂	Agilent Technologies	5	70	330	165, 166

Diol Bonded Phases

Phase	Manufacturer	Particle Size (µm)	Pore Size (Å)	Surface Area (m ² /g)	Page
Chromegabond D/RP	ES Industries	3, 5	60, 100	475, 330	85
COSMOSIL Diol	Nacalai Tesque	5	120	300	76
HECTOR-M Diol	RStech Corporation	3, 5, 10	100	320	2
Inertsil Diol	GL Sciences	3, 5	100	450	88
Inertsil WP Diol		5	300	150	-
Kromasil Diol	Akzo Nobel	5, 10, 16	60	540	-
Kromasil HILIC-D		5	60	540	-
LiChrosorb Diol	Merck	5, 10	100	300	111
LiChrospher Diol		5	100	350	112, 113
NUCLEOSIL Diol	Macherey-Nagel	5, 7	100	350	103, 104
PrincetonSPHER Diol	Princeton Chromatography	3, 5, 10	60, 100	500, 325	134, 135
ProntoSIL Diol	Bischoff	3, 5	120	300	-
YMC Diol	YMC	5	120	330	-
YMC-Triart Diol-HILIC		1.9, 3, 5	120	-	-

Figures 1 and 2 show typical applications on amino and diol bonded columns respectively.

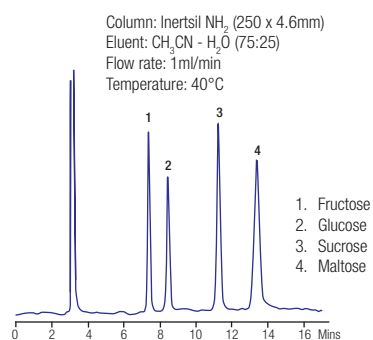

Figure 1. Separation of sugars on amino column

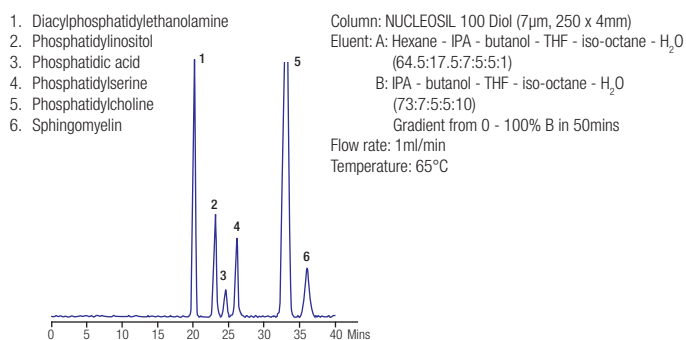

Figure 2. Separation of phospholipids on diol column

HYDROPHILIC INTERACTION CHROMATOGRAPHY (HILIC) PHASES

Introduction

Hydrophilic Interaction Chromatography (HILIC) is a variant of normal-phase chromatography which is performed using polar stationary phases with partially aqueous eluents. The technique combines the characteristics of 3 major liquid chromatography techniques – reversed-phase, normal-phase and ion chromatography. HILIC is an alternative approach to reversed-phase for the effective separation of polar compounds. Solutes elute in the order of increasing hydrophilicity (polarity), the opposite of reversed-phase, thus providing an orthogonal selectivity.

Mode of Operation

Retention in HILIC is proportional to the amount of organic solvent in the eluent. Typical HILIC eluents contain 65-90% acetonitrile or methanol. The low proportion of water in the eluent generates a water-rich layer on the surface of the polar stationary phase. This enables solutes to partition between the eluent and this water-rich layer (Figure 1). In addition, weak electrostatic interactions between solute and stationary phase contribute to overall selectivity. Gradient elution may be performed either with a decreasing organic or increasing salt gradient. Salt is not required for uncharged solutes such as carbohydrates, but typically 10mM salt is necessary with charged solutes such as peptides. Ammonium formate and acetate are suitable volatile buffers for LC-MS.

Several types of HILIC phases have been developed, including unbonded silica, neutral bonded ligands (eg. amide, diol), charged ligands (eg. amino), zwitterionic phases and mixed reversed-phase/HILIC phases. A wide selection of HILIC phases is summarised in the table below.

ERLIC, also referred to as eHILIC, is a subset of HILIC separations which employs charged interactions and their subsequent orientation effects (see PolyLC section for further details).

Aqueous normal-phase (ANP) is a further technique related to HILIC (see pages 115-120 for further details).

Applications

HILIC phases are particularly useful for compounds that are weakly retained by reversed-phase columns. Typical application areas include carbohydrates, oligonucleotides, peptides and proteins, amino acids and natural products.

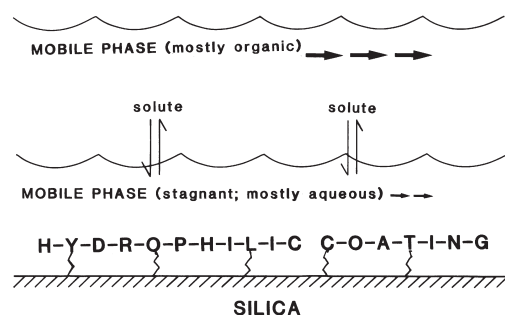
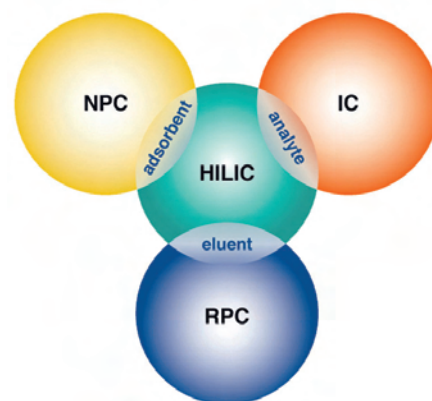

Figure 1. Hypothetical partition mechanism of hydrophilic interaction chromatography (HILIC)

HILIC Phases

Phase	Manufacturer	Functional Group	Particle Size (µm)	Pore Size (Å)	Page
Acclaim HILIC-10		Proprietary	3	120	152
Accucore HILIC ¹		Proprietary	2.6	80	149
Accucore Urea-HILIC ¹	Thermo Scientific	Urea	2.6	80	149
Accucore 150-Amide-HILIC ¹		Amide	2.6	80	149
BioBasic AX		Polyethyleneimine	5	300	153
Brownlee SPP HILIC ¹	Perkin Elmer	Unbonded silica	2.7	90	-
COSMOSIL HILIC	Nacalai Tesque	Triazole	2.5, 5	120	76, 78, 79
Epic HILIC-HC	ES Industries	Polyhydroxylated polymer	1.8, 3, 5, 10	120	85
HALO and HALO-5 HILIC ¹	Advanced Materials	Unbonded silica	2.7, 5	90	91
HALO and HALO-5 Penta-HILIC ¹	Technology	Penta-hydroxy	2.7, 5	90	91
Hypersil GOLD HILIC	Thermo Scientific	Polyethyleneimine	1.9, 3, 5	175	150
Inertsil HILIC	GL Sciences	Propyl alcohol	3, 5	100	87, 88
Kromasil HILIC-D	Akzo Nobel	Diol	5	60	-
NUCLEODUR HILIC		Zwitterionic ammonium	1.8, 3, 5	110	102
NUCLEOSHELL HILIC ¹	Macherey-Nagel	sulphonic acid	2.7	90	102
Obelisc N	SIELC	Proprietary	5	100	147
PolyGLYCOPLEX	PolyLC	-	5, 12	-	127, 128, 130
Synchronis HILIC	Thermo Scientific	Zwitterionic	1.7, 3, 5	100	151
TSKgel Amide-80	Tosoh Bioscience	Carbamoyl	3, 5	100	155
TSKgel NH2-100		Ethylamino	3	100	155
VisionHT HILIC	Grace	-	1.5, 3, 5, 10	120	90
YMC-Triart Diol-HILIC	YMC	Diol	1.9, 3, 5	120	-
ZIC-HILIC		Zwitterionic sulphobetaine	3.5, 5	100, 200	109
ZIC- <i>p</i> HILIC	Merck	Zwitterionic sulphobetaine	5	-	109
ZIC-cHILIC		Zwitterionic phosphorylcholine	3	100	109

¹ Superficially porous phase

SILICA PHASES

Introduction

Despite its porosity, spherical porous HPLC silica exhibits a high mechanical strength compared with other materials. Additionally, it is readily chemically modified. A wide range of porous silicas is available for normal-phase HPLC, characterised by surface area, pore size and particle size measurements.

The use of normal-phase HPLC has not been limited by the silica dissolution or peak tailing problems associated with reversed-phase HPLC. Hence traditional silicas are still commonly used. As an alternative to normal-phase HPLC, some unbonded silica phases are promoted for use as HILIC phases (see page 44).

Particle Size

For analytical work, as the quality and reproducibility of porous silica improves, the use of 3, 3.5 or 4µm particle size materials increases. 10µm particles are less commonly used but remain a key particle size for preparative applications. For economic reasons irregular silicas still share some of this latter market.

Physical Characteristics

The physical characteristics of the newer silica particles have been improved in several ways. However, a number of them are not readily available as they are principally used as a base material for the manufacture of new reversed-phase silicas.

• Surface Activity

A lower level of the unwanted, free and isolated silanol groups is observed. The lower metal ion contaminant level partly contributes to this drop in surface activity. Basic compounds interact less strongly with the silica surface resulting in improved chromatography.

• Physical Properties

Improved control of physical properties such as surface area, pore volume, mean pore diameter and particle size have given the new silicas better lot-to-lot reproducibility.

• Purity

The level of metal ion impurities has in some cases been reduced to cumulative figures < 10ppm. Undesirable chelation of metal ion and solute has been minimised.

Silica Phases

Phase	Manufacturer	Particle Size (µm)	Pore Size (Å)	Surface Area (m ² /g)	Page
ACE SIL	ACT	2 ¹ , 3, 5, 10	100	300	58, 71, 72
Chromolith Si	Merck	-	-	300	110
Cogent Silica-C	MicroSolv	4	100	350	115, 119, 120
COSMOSIL SL-II	Nacalai Tesque	3, 5	120	300	76, 79
Exsil Silica	Grace	5, 10	100	200	86
Genesis Silica		4, 7, 15	120	300	90
HECTOR-M Sil	RStech Corporation	3, 5, 10	100	320	2
Hypersil Silica	Thermo Scientific	3, 5	120	170	151
Hypersil GOLD Silica		1.9, 3, 5	175	220	150
Inertsil SIL	GL Sciences	3, 5	100	450	87
Kromasil Silica	Akzo Nobel	3.5, 5, 7, 10	60, 100	540, 320	-
LiChrosorb Silica	Merck	5, 10	60, 100	500, 300	111
LiChrospher Si		5	60, 100	700, 400	112, 113
NUCLEODUR Silica	Macherey-Nagel	3, 5	110	340	102
NUCLEOSIL Silica		3, 5, 7, 10	100, 120	350, 200	103-105
Partisil Silica	Hichrom	5, 10	-	-	121-125
Partisphere Silica		5	-	-	122, 123
PrincetonSPHER Silica	Princeton Chromatography	3, 5, 10	60, 100	500, 325	134, 135
ProntoSIL Si	Bischoff	3, 5, 10	120	300	-
Purospher STAR Si	Merck	5	120	330	110
Synchronis Silica	Thermo Scientific	1.7, 3, 5	100	320	151
Ultrasphere Silica	Hichrom	3, 5	80	-	156, 157
VisionHT Silica	Grace	1.5, 3, 5, 10	120	220	90
Waters Nova-Pak Silica	Waters	4	60	120	-
Waters Spherisorb Silica		3, 5, 10	80	220	160, 161
YMC Silica	YMC	3, 5	120	300	-
ZORBAX Silica	Agilent Technologies	5	70	330	165, 166

¹ As ACE Excel column

Introduction

Ion-exchange phases separate solutes on the basis of differences in ionic charge. Retention in ion-exchange chromatography is determined by the pH of the eluent, the nature and ionic strength of the buffer and temperature. Column efficiencies are lower than in reversed-phase HPLC. Eluents are normally aqueous but can contain some organic component.

Base Material

Both silica based and polymer based ion-exchangers are available. For the former, ionic species are attached to the silica surface, whereas for the latter the ion-exchange groups are distributed throughout the matrix. Silica based materials maintain a mechanical strength and higher efficiency advantage, whereas the polymer based materials have greater pH stability.

Applications

Ion-exchange is used for the analysis of small ions but the key application area of the technique is the separation of biomolecules such as peptides, proteins and oligonucleotides. Weak ion-exchangers are used for the analysis of inorganic ions, a technique more specifically termed ion chromatography (see page 48).

Ion-Exchange Capacity

The exchange capacity of an ion-exchanger is an important measure of its retentivity (typically measured in milliequivalents per gram material). For any one column the packing density of the phase must also be taken into account. Wide pore materials will typically have lower ion-exchange capacities.

Cation-exchange phases contain negatively charged functional groups and retain positively charged cations. Conversely, anion-exchange phases retain negatively charged analytes by their positively charged functional groups. In the schematics below, the ion strength of the counter ions can be adjusted to shift the equilibrium position and thus the retention times of the analytes.

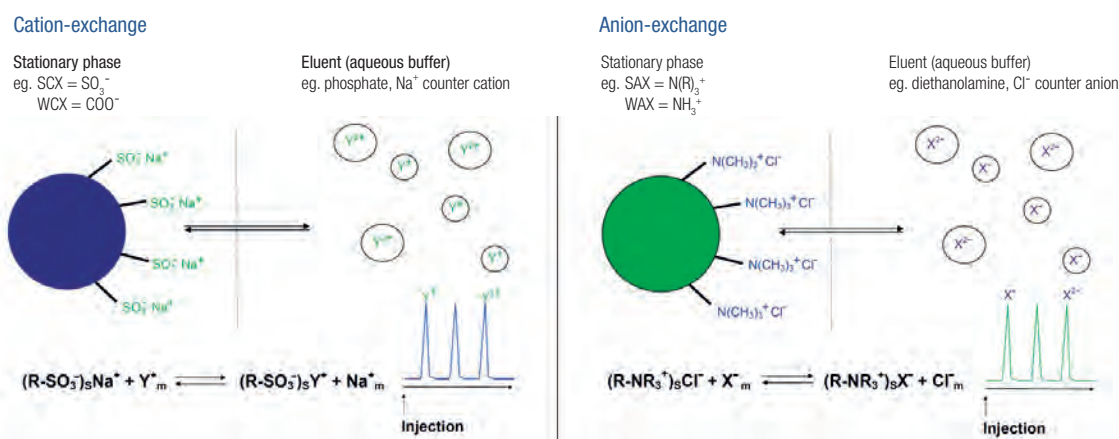

Figure 1. Mechanisms of ion-exchange

Classification

	Type	Strength	Nomenclature	Typical Functionality	pH Ionisation Range
Ion-Exchange	Anion	Weak	WAX	Amine	Ionised at specific pH
		Strong	SAX	Quaternary Ammonium	Ionised over complete pH range
	Cation	Strong	SCX	Sulphonic Acid	
		Weak	WCX	Carboxylic Acid	Ionised at specific pH

Ion-Exchange Phases

Phase	Manufacturer	Base Material	Classification	Particle Size (μm)	Pore Size (\AA)	Applications and Features	Page
BioBasic AX, SCX	Thermo Scientific	Silica	SAX, SCX	5	300	Proteins, peptides, nucleic acids	153
CAPCELL PAK UG SCX	Shiseido	Silica	SCX	5	80	Small molecules	-
COSMOGEL IEX Type Q, Type S	Nacalai Tesque	Polymer	SAX, SCX	5	1000	Proteins, DNA	79
COSMOGEL IEX Type Q-N, Type S-N			SAX, SCX	5	Non-porous		

Ion-Exchange Phases (continued)

Ion-Exchange Phases (continued)

Phase	Manufacturer	Base Material	Classification	Particle Size (µm)	Pore Size (Å)	Applications and Features	Page
Epic SCX	ES Industries	Silica	SCX	1.8, 3, 5, 10	120	Small molecules	85
Eprogen AX300, CM300	Eprogen	Silica	WAX, WCX	6	300	Small molecules	84
Eprogen Q300, S300			SAX, SCX	6	300		84
Exsil SAX, SCX	Grace	Silica	SAX, SCX	5	100	Small molecules	86
Hamilton PRP-X100, PRP-X200	Hamilton	Polymer	WAX, WCX	10	100	Inorganic ion analysis	-
Hamilton PRP-X500, PRP-X600		Polymer	SAX, WAX	7	-	Proteins, DNA oligomers	-
HECTOR-ACD WCX, SCX	RStech Corporation	Silica	WCX, SCX	3, 5, 10	100	Separation of acidic compounds	2
Hypersil GOLD AX, SAX	Thermo Scientific	Silica	WAX, SAX	1.9, 3, 5	175	AX – small proteins and peptides SAX- small molecules	150
Inertsil AX, CX	GL Sciences	Silica	SAX, SCX	5	100	Small molecules	87, 88
MCI GEL ProtEx-DEAE, -SP	Mitsubishi Chemicals	Polymer	WAX, SCX	5			-
MCI GEL CQA Series			SAX, WAX	10	-	Proteins	108
MCI GEL CQK Series			SCX, WCX	10			108
NUCLEOSIL SA, SB	Macherey-Nagel	Silica	SCX, SAX	5, 10	100	Small molecule analysis	103, 104
NUCLEOGEN DEAE			WAX	7	60, 500, 4000	Bioanalytical	102
Partisil SAX, SCX	Hichrom	Silica	SAX, SCX	5, 10	-	Small molecule analysis	121-125
Partisphere SAX, SCX			SAX, SCX	5	-		122, 123
PolyCAT A			WCX		300, 1000, 1500	Aspartic acid functionality	127, 128, 130
PolySULFOETHYL A	PolyLC	Silica	SCX	3, 5, 12	200, 300, 1000	Sulfoethylaspartamide	127, 129, 130
PolyWAX			WAX		100, 300, 1000, 1500	Proteins with isoelectric point <6.0	127-130
PL-SAX, PL-SCX	Agilent Technologies	Polymer	SAX, SCX	8, 10	1000	Protein applications	-
ProPac WCX-10, SCX-10, WAX-10, SAX-10	Thermo Scientific	Polymer	WCX, SCX, WAX, SAX	10	Non-porous	Proteins variants	153
Asahipak ES-502N, ES-502C	Shodex	Polymer	WAX, WCX	9	-	Proteins, peptides, oligonucleotides	140
Shodex IEC QA			SAX	12	-		140
Shodex IEC DEAE, SP, CM			WAX, SCX, WCX	8	-		140
TSKgel DEAE-2SW, CM-2SW	Tosoh Bioscience	Silica	WAX, WCX	5	125	Nucleotides, drug molecules, catecholamines	155
TSKgel DEAE-3SW, CM-3SW			WAX, WCX	10	250		155
TSKgel SuperQ-5PW, DEAE-5PW, SP-5PW, CM-5PW		Polymer	SAX, WAX, SCX, WCX	10, 13	1000	Enzymes, proteins, DNA, nucleic acids	155
TSKgel BioAssist Q		Polymer	SAX	10, 13	~4000	Plasmids, antibodies and other large proteins	155
TSKgel BioAssist S		Polymer	SCX	7, 13	~1300		155
TSKgel Q-STAT, CM-STAT, SP-STAT		Non-porous resin	SAX, WCX, SCX	7, 10	Non-porous	Nucleic acids, mAb variants, protein aggregates	155
TSKgel DNA-STAT		SAX	5				155
Waters Spherisorb SAX, SCX	Waters	Silica	SAX, SCX	5	80	Small molecules	160, 161
YMC-BioPro QA, SP	YMC	Hydrophilic polymer	SAX, SCX	5	1000	Peptides, proteins, nucleic acids, other biomolecules	-
YMC-BioPro QA-F, SP-F			SAX, SCX	5	Non-porous		-
ZirChrom SAX, WAX	ZirChrom Separations	Zirconia	SAX, WAX	3, 5	300	Inorganic and organic anions, biomolecules	162-164
ZirChrom SHAX, WCX			SAX, WCX				Proteins

Introduction

Ion chromatography (IC) is a special form of ion-exchange chromatography developed as a means of separating the ions of strong acids and bases. The most important form of ion chromatography involves a combination of specific ion-exchange phases with conductivity detection. It is a sensitive technique, in some cases being able to detect ppb levels of ions.

Suppressed or Non-Suppressed Detection

Eluents used in IC contain a relatively high level of salt ions and therefore exhibit high conductivity. This leads to a high background signal which could inhibit the detection of low level analytes. Suppression of eluent conductivity post column is necessary for efficient detection of sample ions and is the most common method for anion analyses. Although isocratic elution is more commonly used, the use of suppressors enables gradient elution to be used for complex samples.

Phases

Silica and polymer based phases are available for anion and cation analyses. Silica based columns, although showing better efficiency, have a limited pH range. As a result, they are not compatible with anion IC methods requiring suppressed detection, due to the high pH of the eluents required. Polymer based materials are stable over a wider pH range and have higher capacities.

Tables 1 and 2 show typical base materials and bonding for anion and cation chromatography phases respectively. The majority of phases for anion chromatography are bonded with quaternary ammonium groups, with a permanent cationic charge. For cation chromatography phases, sulphonate is the most common functionality. Columns optimised for non-suppressed IC generally have lower capacity than those for suppressed detection, in order to achieve a relatively low background conductivity. They are therefore not suitable for suppressed detection.

Eluents

The choice of eluent for IC depends on whether the method is suppressed or non-suppressed. For suppressed anion IC, carbonate/bicarbonate or hydroxide are the most common eluents. Hydroxide eluents have the advantage of producing water only in the suppressor and thereby giving a very low background conductivity. However, some phases are not stable at the high pH (12) of this eluent. For non-suppressed anion IC analyses, typical eluents include p-hydroxybenzoic acid and phthalic acid. Typical eluents for suppressed and non-suppressed cation IC include HCl, HNO₃, tartaric acid and succinic acid.

Applications

High sensitivity ion analyses are important in a wide spectrum of industries including pharmaceutical, food, water, semiconductor etc. In addition to the common inorganic anions eg. F⁻, Cl⁻, NO₂⁻, NO₃⁻, SO₄²⁻, acid salts can also be analysed by IC eg. formate, acetate. Quantitative analysis of anions at the ppb level can be achieved. Cation chromatography is used for the separation and detection of Group I and II metal ions, in addition to some transition metal ions, ammonium ions and ethanolamines. Small ions are generally eluted before larger ions and monovalent ions before di- and trivalent ions.

Table 1. Anion Chromatography Phases

Base Material	Functional Group	Typical pH Range
Silica	Quaternary ammonium	2 – 5.5
Polystyrene-divinylbenzene	Quaternary ammonium	2 – 12
Polymethacrylate	Quaternary ammonium	2 – 10
Polyvinyl alcohol	Quaternary ammonium	3 – 12

Table 2. Cation Chromatography Phases

Base Material	Functional Group	Typical pH Range
Silica	Carboxylate, sulphonate	2 – 7
Silica	Polybutadiene/maleic acid coating	2 – 7
Polystyrene-divinylbenzene	Sulphonate	2 – 12

A selection of ion chromatography columns can be found in the following sections:

MCI GEL page 107
Shodex page 140

Please contact Hichrom for advice on further IC column selection.

SIZE EXCLUSION CHROMATOGRAPHY (SEC) PHASES

Introduction

SEC columns separate components according to their molecular size in solution, larger molecules eluting first. Separation is achieved by the differential exclusion or inclusion of components within the packing material particles. In addition to the separation of discrete components, the technique is used for characterising the molecular weight distribution of polymers.

Base Material

Silica based SEC materials generally exhibit higher resolving power than polymer based materials. However, polymer based materials show greater stability for use with high pH eluents. Polymeric packing materials are generally available in larger particle sizes, which may be more practical for large-scale preparative separations.

Modes of Operation

Gel permeation chromatography (GPC) refers to the SEC separation of organic soluble polymers using an organic solvent as the eluent. Gel filtration chromatography (GFC) refers to the SEC separation of water soluble polymers in aqueous eluents. SEC separations exhibit lower resolving power and capacity compared with adsorptive HPLC techniques.

Applications

SEC analyses do not normally result in the denaturation of samples, making the technique a suitable choice for biological samples where activity must be retained. A wide range of biomolecules and organic polymers are separated by SEC. For samples of wide molecular weight distribution, it can be useful to use a mixed pore size phase or to couple columns of one or more pore sizes in series.

Size Exclusion Chromatography Phases

Phase / Series	Manufacturer	Base Material / Bonding	Mode	Pore Sizes (Å)	Typical Applications	Page
GPC PEPTIDE	Eprogen	Glycerol bonded silica	GFC	50	Small peptides	84
GPC100, 300, 500, 1000, 4000			GFC	100, 300, 500, 1000, 4000	Proteins, carbohydrates, nucleic acids, water soluble polymers	84
GPC LINEAR			GFC	100-1000	Organic polymers, denatured proteins	84
CATSEC		Silica with polymerised polyamine coating	GFC	100, 300, 1000	Cationic polymers	84
MCI GEL CQP	Mitsubishi Chemical Corp.	Polyhydroxymethacrylate	GFC	120, 200, 600	Proteins, peptides, enzymes and other biomolecules	108
PLgel	Agilent Technologies	Polystyrene-divinylbenzene	GPC	50, 100, 500, 1000, 10,000, 100,000, MIXED	Oils, oligomers, high MW synthetic polymers, starches, polystyrenes, resins	-
PL aquagel-OH 30, 40, 50, 60, MIXED		Polystyrene-divinylbenzene with polyhydroxyl functionality	GFC	-	Surfactants, polysaccharides, polyacrylamides, starches, gum	-
PolyHYDROXYETHYL A	PolyLC	Silica with hydroxyethylaspartamide coating	GFC	60, 100, 200, 300, 500, 1000, 1500	Peptides, proteins, carbohydrates, small molecules	127, 130
Asahipak GF	Showa Denko	Polyvinyl alcohol	GFC/ GPC	400, 2000, 10000	Hydrophilic and hydrophobic compounds	142
Shodex GPC		Styrene-divinylbenzene	GPC	Various	Polymers, plastics	142
Shodex OHpak SB		Polyhydroxymethacrylate	GFC	Various	Water soluble samples	141
Shodex PROTEIN KW		Silica	GFC	400, 1000, 1500	Proteins	141
Acclaim SEC		Hydrophilic polymethacrylate	GFC	300, 1000	Water soluble polymers	-
BioBasic SEC	Thermo Scientific	Silica	GFC	60, 120, 300, 1000	Peptides and proteins	153
MABPac SEC-1		Silica	GFC	300	Monoclonal antibodies and aggregates	153
TSKgel SW		Silica	GFC	125, 250, 450	Proteins, antibodies, enzymes, nucleic acids	154
TSKgel PW	Tosoh Bioscience	Polymethacrylate	GFC	<100, 125, <200, 200, 500, 1000, >1000	Water soluble organic polymers, polysaccharides, DNA	154
TSKgel H		Polystyrene-divinylbenzene	GPC	-	Oligomers, polymers and polymer additives	154
TSKgel Alpha and SuperAW		Hydrophilic polyvinyl	GFC/ GPC	-	Organic and water soluble polymers	154
ZORBAX GF Series	Agilent Technologies	Zirconia-clad silica	GFC	150, 300	Proteins, peptides	-

Introduction

Affinity chromatography offers the highest specificity and selectivity in biomolecular separations and purifications. Purifications up to several orders of magnitude can be achieved in a single step. Affinity separations can often remove contaminants difficult to eliminate using conventional chromatographic procedures.

Mechanism

The basis of affinity chromatography is a 'lock and key' type mechanism. An affinity ligand, specific for a binding site on the target molecule, is coupled to an inert chromatography matrix. Using suitable binding conditions, target molecules are bound to the affinity ligand according to its specificity. Unbound solutes are washed through the column. The adsorbed target molecules are then desorbed and eluted from the column. Purification of several thousand-fold may be obtained due to the high selectivity of the affinity interactions.

Group specific affinity resins (eg. Tosoh Bioscience) bind molecules sharing specific structural features. Alternatively, if greater specificity is required, ligands with precise specificity for the target molecule can be used. For example, the Protein A phase has specific affinity for the Fc region of immunoglobulins.

Immunoaffinity Chromatography

Immunoaffinity chromatography is a specialised form of affinity chromatography, utilising an antibody or antibody fragment as the ligand immobilised on to a solid support in such a manner that its binding capacity is retained.

Figure 1 shows a schematic diagram of the stages involved in a typical immunoaffinity analysis: loading the sample, washing the column to remove matrix components and impurities and eluting the target compound.

Applications

Affinity and immunoaffinity chromatography techniques are applicable in a variety of disciplines including biochemistry, immunochemistry, virology and molecular biology. Due to the increasing availability of a variety of antibodies, separations based on immunoaffinity techniques are being increasingly used in a wide range of applications involving the purification of complex biological samples.

The main application areas of immunoaffinity chromatography are proteins and enzymes. Method selectivity can be enhanced by combining the pre-concentration and pre-treatment of samples offered by immunoaffinity phases, with the separation capabilities of reversed-phase HPLC. The technique can also be used prior to MS analyses in proteomics.

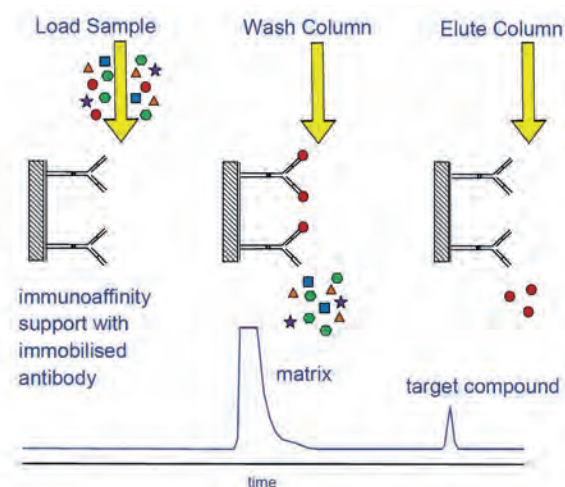

Figure 1. Typical Immunoaffinity Analysis

Affinity and Immunoaffinity Phases

Phase Range	Manufacturer	Base Material	Particle Size (µm)	Features	Page
AFpak	Shodex	Polyhydroxymethacrylate	18	6 different ligands available	142
ProPac IMAC-10	Thermo Scientific	Non-porous polystyrene-divinylbenzene	10	Used for separation of proteins and peptides by immobilised metal affinity chromatography	153
ProSwift ConA-1S	Thermo Scientific	Polymethacrylate monolith	-	Used for purification of Concanavalin A binding glycans, glycopeptides and glycoproteins	153
TSKgel	Tosoh Bioscience	Polymethacrylate	10	Group specific affinity phases for analysis of peptides, proteins and nucleic acids	155
TOYOPEARL	Tosoh Bioscience	Polymethacrylate	40 – 90 (30 – 60 for Protein A)	Various ligands. Bulk media	155

In many biological processes, the activity of one member of an enantiomeric pair can be contrasted with the inactivity or even harmful activity of the other. The successful development of chiral stationary phases (CSPs) for HPLC and SFC now allows us to monitor the optical purity of a bulk drug and its presence in formulations or biological fluids. Further applications can be found within the agrochemical and related industries. The main types of HPLC/SFC CSPs are discussed below, with examples listed on pages 52-53. Please contact us for information on GC chiral phases.

Immobilised Polysaccharide CSPs

Coated polysaccharide CSPs are limited in the solvents that may be used in the eluent and as sample diluents. Newer immobilised CSPs allow the use of a more robust and expanded range of solvents and bring new selectivity and higher sample solubility relative to conventionally coated CSPs.

Cellulose and Amylose Bound

Cellulose and amylose are linear polymers of optically active glucose units with molecular weights of 250,000 to 1,000,000. Cross-linked derivatives of these materials coated onto silica give unique chiral selectivity. Their chiral recognition properties depend on the 'steric fit' of guest enantiomers into the material's cavities. Choice of eluent is the key factor affecting chiral recognition.

'Brush-Type'

Although 'brush-type' (Pirkle) chiral selectors are relatively simple molecules, their well defined structure contains three types of functional groups capable of participating in charge transfer (π - π bonding), hydrogen bonding ('dipole stacking' interactions) and steric effects. The monolayer of chiral selector covalently bound to the silica surface usually gives a column of relatively high capacity and efficiency but often with limited chiral discrimination ability. Since the synthesis of the popular D-3,5-dinitrobenzoylphenylglycine phase, significant numbers of these multiple interaction CSPs have been synthesised. Polyaromatic hydrocarbon derivative CSPs are the most recent additions to the range. All 'brush-type' phases are typically used with normal-phase eluents.

Protein Bound

Proteins are high molecular weight polymers containing chiral sub-units. When bound to silica they act as very effective CSPs. The binding or complexation of small enantiomeric molecules is often stereospecific, especially for serum proteins such as α_2 -acid glycoprotein (AGP) or human serum albumin (HSA). The additional stability of the Ultron ES-OVM and ES-Pepsin columns enable them to be used with high organic content eluents. Immobilised enzymes can similarly be used. Protein immobilised CSPs are typically used in buffered aqueous eluents compatible with many biological samples. They offer good selectivity. Enantiomer retention and stereoselectivity can often be significantly altered by changes in eluent pH or modifier concentration. Their low capacity makes them unsuitable for preparative applications.

Cyclodextrin Inclusion

Cyclodextrins are a class of oligosaccharides containing six to twelve optically active glucose units. They are covalently bound to silica to form the corresponding CSP. The physical shape of these molecules is that of a truncated cone, the internal diameter of which is proportional to the number of glucose units. The interior of the cavity is relatively hydrophobic. Secondary hydroxyl groups at the entrance to the cavity contribute to the separation process. The relative stability of the inclusion complexes formed by the enantiomers of the guest molecule at the edge of the cyclodextrin cavity dictates the degree of separation. β -Cyclodextrin and its derivatives are the most commonly used CSPs of this type. Cyclodextrin CSPs are used in reversed-phase and are suitable for preparative separations.

Crown Ether

Chiral recognition with crown ether phases is achieved when a complex is formed between the crown ether and an ammonium ion from the analyte. These phases are used for solutes with a primary amino group at or near its chiral centre, such as amino acids and amino alcohols.

Ligand Exchange

Ligand exchange chiral phases are characterised by the attachment of a chiral chelating ligand to the stationary support. In the presence of an appropriate transition metal cation such as copper (II), a molecular complex is formed with the chiral stationary phase ligand and the analyte. Compounds that are suitable for chiral ligand exchange are α -amino acids, hydroxy acids and small peptides.

Network Polymeric

In a network polymeric CSP the chiral selector is anchored into a network polymer by a cross-linking reaction which simultaneously bonds it to the silica. The aim is to combine in one CSP the efficiency and capacity of 'brush-type' structures with the chiral recognition power of those phases based on chiral polymers.

Chiral Phases (continued)

Chiral Phases

Phase	Manufacturer	Chiral Type	Chiral Selector	Particle Size (μm)	Features	Page	
CHIRA-chrom-1	Hichrom	Brush	D-Phenylglycine	5	High efficiency and capacity. Low cost	100	
			L-Phenylglycine	5		100	
			L-Leucine	5		100	
CHIRA-chrom-2			Dinitrophenyltartramide	5		100	
ChiraDex	Merck	Cyclodextrin	β -Cyclodextrin	5	Forms inclusion complexes	110	
CHIRALPAK AGP		Protein	α_1 -Acid glycoprotein	5	Widely used. pH variation a useful tool	75	
CHIRALPAK CBH		Enzyme	Cellobiohydrolase	5		75	
CHIRALPAK HSA		Protein	Human serum albumin	5		75	
CHIRALPAK IA		Amylose	Immobilised amylose derivative	3, 5	Broad application range	74	
CHIRALPAK IB		Cellulose	Immobilised cellulose derivative	3, 5		74	
CHIRALPAK IC		Cellulose	Cellulose derivative	3, 5		74	
CHIRALPAK ID		Amylose		3, 5		74	
CHIRALPAK IE	Chiral Technologies ²	Amylose	Immobilised amylose derivative	3, 5		74	
CHIRALPAK IF		Amylose		3, 5		74	
CHIRALPAK AD		Amylose	Amylose derivative	3, 5, 10		Unique separation applications. Very versatile	74
CHIRALPAK AS				3, 5, 10			74
CHIRALCEL OD		Cellulose	Cellulose derivative	3, 5, 10			74
CHIRALCEL OJ				3, 5, 10			74
CHIRALPAK QD-AX		Anion-exchange	Quinidine derivative	5	Useful for chiral acids	75	
CHIRALPAK QN-AX			Quinine derivative	5		75	
CROWNPAK		Crown ether	18-crown-6 type crown ether	5	Suitable for amino acids and primary amines	75	
Chirobiotic R	Supelco ¹	Macrocyclic glycopeptide	Ristocetin A	5	Broad selectivity	-	
Chirobiotic T			Teicoplanin	5		-	
Chirobiotic V			Vancomycin	5		-	
Cyclobond I		Cyclodextrin	β -Cyclodextrin	5	Forms inclusion complexes	-	
Cyclobond II			γ -Cyclodextrin	5		-	
ChiroSil	Regis/RStech	Crown ether	(18-crown-6)-tetracarboxylic acid	5, 10	Suitable for primary amines and amino acids	137	
DACH-DNB				5	π -electron acceptor/donor. Widely used	136	
ULMO				5		136	
Whelk-01/Whelk-02				5, 10		136	
α -Burke 2		Brush	3,5-Dinitrobenzoyl derivatives	5		136	
β -GEM 1				5		136	
Leucine				5		136	
Phenylglycine	Regis			5	π -electron acceptor	136	
Pirkle-1J			β -Lactam derivative	5		136	
RegisCell		Cellulose	Cellulose derivative	5, 10	Broad application range	137	
RegisPack		Amylose	Amylose derivative	5, 10		137	
RegisPack CLA-1		Amylose	Chlorinated amylose derivative	10	Complementary selectivity to RegisCell and RegisPack	137	
Kromasil AmyCoat	Akzo Nobel	Amylose	Amylose derivative	3, 5, 10	Broad application range	-	
Kromasil CelluCoat		Cellulose	Cellulose derivative			-	
Kromasil DMB		Network polymer	Acylated N,N'-diallyl-L-tartardiamide	5, 10	High stability and capacity. Suitable for preparative applications	-	
Kromasil TBB				5, 10		-	

¹ Please contact Hichrom for ordering information² CHIRALPAK ZWIX phases also available – see page 75

Chiral Phases (continued)

Chiral Phases (continued)

Phase	Manufacturer	Chiral Type	Chiral Selector	Particle Size (μm)	Features	Page	
NUCLEODEX β -OH	Macherey-Nagel	Cyclodextrin	β -Cyclodextrin	5	Reversed-phase applications	102	
NUCLEODEX α -PM			Permethyated α -, β - and γ -cyclodextrins respectively	5		102	
NUCLEODEX β -PM				5		102	
NUCLEODEX γ -PM				5		102	
NUCLEOSIL CHIRAL-1			Ligand exchange	L-Hydroxyproline- Cu^{2+} complex		5	α -Amino acid applications
RESOLVOSIL BSA-7	Protein	Bovine serum albumin	7		102		
NUCLEOCEL DELTA		Cellulose	Cellulose derivative	5	Broad application range	102	
ORpak CDA	Shodex	Cyclodextrin	α -Cyclodextrin	6	Polyhydroxymethacrylate base material	142	
ORpak CDB			β -Cyclodextrin	6		142	
ORpak CDC			γ -Cyclodextrin	6		142	
ORpak CDBS			β -Cyclodextrin	3		Silica base	142
ORpak CRX			Ligand exchange	L-Amino acid derivative		6	Suitable for underivatized amino acids
Ultron ES-OVM	Shinwa Chemical Industries	Protein	Ovomucoid	5, 10	USP L57 column	158	
Ultron ES-Pepsin			Pepsin	5	Suitable for basic compounds	158	
Ultron ES-CD		Cyclodextrin	β -Cyclodextrin	5	Suitable for hydrophobic cyclic compounds	158	
Ultron ES-PhCD			Phenylcarbamated β -cyclodextrin	5		158	
YMC Chiral CD BR	YMC ³	Cyclodextrin	Bromide derivatives of cyclodextrin (α , β or γ)	5	Separates wide range of polar compounds	-	
YMC Chiral NEA		Brush	α -Naphthylethylamine	5	NP or RP applications	-	
YMC Sumichiral OA series		Various	Various	5	17 different phases	-	
ZirChrom Chiral LEU	ZirChrom	Brush	Leucine derivative	3, 5	Zirconia base material	163	
ZirChrom Chiral NESAs			Naphthylethylsuccinamic acid derivative	3, 5		163	
ZirChrom Chiral PG			Phenylglycine derivative	3, 5		163	
ZirChrom CelluloZe			Cellulose	Cellulose derivative		3, 5	163

³ YMC CHIRAL polysaccharide phases also available – please enquire

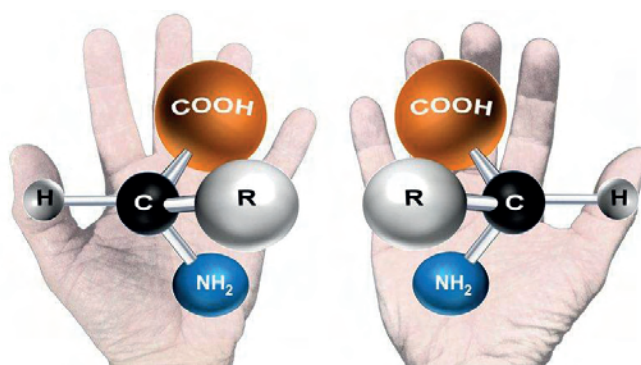

The following list of USP (United States Pharmacopoeia) column specifications (USP 35) includes a selection of recommended columns within each category. In most cases there are several columns available within a given category, but in a few indicated instances a packing very closely fitting the specification has been included. Please contact us for further advice and assistance on selecting a suitable column by USP specification. Please also contact us for advice on column selection by EP (European Pharmacopoeia) specification. The USP monographs allow chromatographers flexibility to make method adjustments within specified limits in order to meet system suitability requirements. Please see page 57 for further details.



L1	Octadecylsilane chemically bonded to porous or non-porous silica or ceramic microparticles, 1.5 to 10µm in diameter, or a monolithic rod <i>Widely available</i>
L2	Octadecylsilane chemically bonded to silica gel of a controlled surface porosity that has been bonded to a solid spherical core, 30 to 50µm in diameter <i>Pellicular ODS</i>
L3	Porous silica particles, 1.5 to 10µm in diameter, or a monolithic silica rod <i>Widely available</i>
L4	Silica gel of controlled surface porosity bonded to a solid spherical core, 30 to 50µm in diameter <i>Pellicular silica</i>
L5	Alumina of controlled surface porosity bonded to a solid spherical core, 30 to 50µm in diameter <i>Please enquire</i>
L6	Strong cation-exchange packing – sulphonated fluorocarbon polymer coated on a solid spherical core, 30 to 50µm in diameter <i>Please enquire</i>
L7	Octylsilane chemically bonded to totally or superficially porous silica particles, 1.5 to 10µm in diameter, or a monolithic silica rod <i>Widely available</i>
L8	An essentially monomolecular layer of aminopropylsilane chemically bonded to totally porous silica gel support, 1.5 to 10µm in diameter <i>Widely available</i>
L9	Irregular or spherical, totally porous silica gel having a chemically bonded, strongly acidic cation-exchange coating, 3 to 10µm in diameter <i>Partisil SCX NUCLEOSIL SA</i>
L10	Nitrile groups chemically bonded to porous silica particles, 1.5 to 10µm in diameter <i>Widely available</i>
L11	Phenyl groups chemically bonded to porous silica particles, 1.5 to 10µm in diameter <i>Widely available</i>
L12	A strong anion-exchange packing made by chemically bonding a quaternary amine to a solid silica spherical core, 30 to 50µm in diameter <i>Please enquire</i>
L13	Trimethylsilane chemically bonded to porous silica particles, 3 to 10µm in diameter <i>YMC TMS Exsil C1 Develosil TMS-UG</i>
L14	Silica gel having a chemically bonded, strongly basic quaternary ammonium anion-exchange coating, 5 to 10µm in diameter <i>NUCLEOSIL SB Exsil SAX Partisil SAX</i>
L15	Hexylsilane chemically bonded to totally porous silica particles, 3 to 10µm in diameter <i>Spherisorb C6 Chromegabond C6</i>
L16	Dimethylsilane chemically bonded to porous silica particles, 5 to 10µm in diameter <i>NUCLEOSIL C2 Chromegabond C2</i>
L17	Strong cation-exchange resin consisting of sulphonated cross-linked styrene-divinylbenzene copolymer in the hydrogen form, 6 to 12µm in diameter <i>Hamilton HC-75 H⁺ Shodex SUGAR SH1011 NUCLEOGEL Sugar 810H</i>
L18	Amino and cyano groups chemically bonded to porous silica particles, 3 to 10µm in diameter <i>Partisil PAC Partisphere PAC</i>
L19	Strong cation-exchange resin consisting of sulphonated cross-linked styrene-divinylbenzene copolymer in the calcium form, about 9µm in diameter <i>Hamilton HC-75 Ca²⁺ NUCLEOGEL Sugar 810 Ca Shodex SUGAR SC1011</i>
L20	Dihydroxypropane groups chemically bonded to porous silica or hybrid particles, 1.5 to 10µm in diameter <i>LiChrospher Diol NUCLEOSIL Diol PrincetonSPHER Diol</i>
L21	A rigid, spherical styrene-divinylbenzene copolymer, 3 to 30µm in diameter <i>Hamilton PRP-1 PLRP-S Shodex RSpak RP18</i>
L22	A cation-exchange resin made of porous polystyrene gel with sulphonic acid groups, about 10µm in size <i>Hamilton PRP-X200 Shodex SUGAR SH1011</i>
L23	An anion-exchange resin made of porous polymethacrylate or polyacrylate gel with quaternary ammonium groups, 7 to 12µm in size <i>TSKgel BioAssist Q COSMOGEL QA Shodex IEC QA-825</i>

HPLC Column Selection by USP Specifications (continued)

L24	Polyvinyl alcohol chemically bonded to porous silica particles, 5µm in diameter <i>YMC-Pack PVA-Sil</i>
L25	Packing having the capacity to separate compounds with a molecular weight range from 100-5000 (as determined by polyethylene oxide), applied to neutral, anionic, and cationic water-soluble polymers. A polymethacrylate resin base, cross-linked with polyhydroxylated ether (surface contained some residual carboxyl functional groups) was found suitable <i>TSKgel G2500PW_{XL} Shodex OHpak SB-802HQ</i>
L26	Butylsilane chemically bonded to totally porous silica particles, 1.5 to 10µm in diameter <i>Widely available</i>
L27	Porous silica particles, 30 to 50µm in diameter <i>YMC Silica LiChroprep Silica Develosil Silica NUCLEODUR Silica</i>
L28	A multifunctional support, which consists of a high purity, 100Å, spherical silica substrate that has been bonded with anionic exchanger, amine functionality in addition to a conventional reversed-phase C8 functionality <i>Alltech Mixed-Mode C8/Anion</i>
L29	Gamma alumina, reversed-phase, low carbon percentage by weight, alumina-based polybutadiene spherical particles, 5µm in diameter with a pore volume of 80Å units <i>GammaBond RP1</i>
L30	Ethylsilane chemically bonded to totally porous silica particles, 3 to 10µm in diameter <i>As for L16¹</i>
L31	A hydroxide-selective, strong anion-exchange resin-quaternary amine bonded on latex particles attached to a core of 8.5µm macroporous particles having a pore size of 2000Å units and consisting of ethylvinylbenzene cross-linked with 55% divinylbenzene <i>IonPac AS11-HC</i>
L32	A chiral ligand-exchange resin packing - L-proline copper complex covalently bonded to irregularly shaped silica particles, 5 to 10µm in diameter <i>NUCLEOSIL Chiral-1 CHIRALCEL WH</i>
L33	Packing having the capacity to separate dextrans by molecular size over a range of 4,000 to 500,000 Da. It is spherical, silica-based, and processed to provide pH stability <i>TSKgel G4000SW_{XL} Shodex PROTEIN KW-800 series</i>
L34	Strong cation-exchange resin consisting of sulphonated cross-linked styrene-divinylbenzene copolymer in the lead form, about 7 to 9µm in diameter <i>Hamilton HC-75 Pb²⁺ Shodex SUGAR SP0810</i>
L35	A zirconium-stabilised spherical silica packing with a hydrophilic (diol-type) molecular monolayer bonded phase having a pore size of 150Å <i>ZORBAX GF-250</i>
L36	A 3,5-dinitrobenzoyl derivative of L-phenylglycine covalently bonded to 5µm aminopropyl silica <i>Hichrom CHIRA-chrom-1</i>
L37	Packing having the capacity to separate proteins by molecular size over a range of 2,000 to 40,000 Da. It is a polymethacrylate gel <i>TSKgel G3000PW_{XL} Shodex OHpak SB-803HQ</i>
L38	A methacrylate-based size-exclusion packing for water-soluble samples <i>TSKgel G1000-G6000PW_{XL} Shodex OHpak SB-800HQ Series</i>
L39	A hydrophilic polyhydroxymethacrylate gel of totally porous spherical resin <i>TSKgel G1000-G6000PW_{XL} Shodex OHpak SB-800HQ Series</i>
L40	Cellulose tris-3,5-dimethylphenylcarbamate coated porous silica particles, 5µm to 20µm in diameter <i>CHIRALCEL OD-H RegisCell NUCLEOCEL DELTA</i>
L41	Immobilised α ₁ -acid glycoprotein on spherical silica particles, 5µm in diameter <i>CHIRALPAK AGP</i>
L42	Octylsilane and octadecylsilane groups chemically bonded to porous silica particles, 5µm in diameter <i>Hichrom RPB</i>
L43	Pentafluorophenyl groups chemically bonded to silica particles by a propyl spacer, 1.5 to 10µm in diameter <i>HALO PFP Hypersil GOLD PFP Partisphere TAC-1</i>
L44	A multifunctional support, which consists of a high purity, 60Å, spherical silica substrate that has been bonded with a cationic exchanger, sulphonic acid functionality in addition to a conventional reversed phase C ₈ functionality <i>Chromegabond RP-SCX</i>
L45	Beta cyclodextrin, R,S-hydroxypropyl ether derivative, bonded to porous silica particles, 5 to 10µm in diameter <i>ChiraDex NUCLEODEX β-OH Ultron ES-CD</i>
L46	Polystyrene/divinylbenzene substrate agglomerated with quaternary amine functionalised latex beads, about 9µm to 11µm in diameter <i>CarboPac PA1</i>
L47	High capacity anion-exchange microporous substrate, fully functionalised with a trimethylamine group, 8µm in diameter <i>CarboPac MA1</i>

¹ Column represents the closest match to USP specifications

HPLC Column Selection by USP Specifications (continued)

L48	Sulphonated, cross-linked polystyrene with an outer layer of sub-micron, porous, anion-exchange microbeads, 5 to 15µm in diameter <i>IonPac AS5</i>
L49	A reversed-phase packing made by coating a thin layer of polybutadiene on to spherical porous zirconia particles, 3 to 10µm in diameter <i>ZirChrom PBD</i>
L50	Multi-function resin with reversed-phase retention and strong anion-exchange functionalities. The resin consists of ethylvinylbenzene, 55% cross-linked with divinylbenzene copolymer, 3 to 15µm in diameter, and a surface area of not less than 350 m ² /g. Substrate is coated with quaternary ammonium functionalised latex particles consisting of styrene cross-linked with divinylbenzene <i>OmniPac PAX-500</i>
L51	Amylose tris-3,5-dimethylphenylcarbamate-coated, porous, spherical, silica particles, 5 to 10µm in diameter <i>CHIRALPAK AD RegisPack</i>
L52	A strong cation-exchange resin made of porous silica with sulphopropyl groups, 5 to 10µm in diameter <i>BioBasic SCX TSKgel SP-2SW</i>
L53	Weak cation-exchange resin consisting of ethylvinylbenzene, 55% cross-linked with divinylbenzene copolymer, 3 to 15µm diameter. Substrate is surface grafted with carboxylic acid and/or phosphoric acid functionalised monomers. Capacity not less than 500 µEq/column <i>IonPac CS14</i>
L54	A size exclusion medium made of covalent bonding of dextran to highly cross-linked porous agarose beads, about 13µm in diameter <i>Please enquire</i>
L55	A strong cation-exchange resin made of porous silica coated with polybutadiene-maleic acid copolymer, about 5µm in diameter <i>Universal Cation</i>
L56	Propyl silane chemically bonded to totally porous silica particles, 3 to 10µm in diameter <i>Zorbax SB-C3</i>
L57	A chiral-recognition protein, ovomucoid, chemically bonded to silica particles, about 5µm in diameter, with a pore size of 120Å <i>Ultron ES-OVM</i>
L58	Strong cation-exchange resin consisting of sulphonated cross-linked styrene-divinylbenzene copolymer in the sodium form, about 6 to 30µm in diameter <i>PL Hi-Plex Na Shodex SUGAR KS series</i>
L59	Packing for the size exclusion separations of proteins (separation by molecular weight) over the range of 5 to 7000 kDa. It is spherical (1.5 to 10µm), silica or hybrid packing with a hydrophilic coating <i>TSKgel G3000SW_{XL} Shodex PROTEIN KW-803</i>
L60	Spherical, porous silica gel, 10µm or less in diameter, the surface of which has been covalently modified with alkyl amide groups and endcapped <i>HALO RP-Amide Discovery RP-Amide</i>
L61	A hydroxide-selective, strong anion-exchange resin consisting of a highly cross-linked core of 13µm microporous particles having a pore size less than 10Å units and consisting of ethylvinylbenzene cross-linked with 55% divinylbenzene with a latex coating composed of 85nm diameter microbeads bonded with alkanol quaternary ammonium ions (6%) <i>IonPac AS11</i>
L62	C30 silane bonded phase on a fully porous spherical silica, 3 to 15µm in diameter. <i>PrincetonSPHER C30 Develosil C30 Cogent C30</i>
L63	Glycopeptide teicoplanin linked through multiple covalent bonds to a 100Å units spherical silica <i>CHIROBIOTIC T</i>
L64	Strongly basic anion-exchange resin consisting of 8% crosslinked styrene-divinylbenzene copolymer with a quaternary ammonium group in the chloride form, 45 to 180µm in diameter <i>AG 1-X8</i>
L65	Strongly acidic cation-exchange resin consisting of 8% sulphonated crosslinked styrene-divinylbenzene copolymer with a sulphonic acid group in the hydrogen form, 63 to 250µm in diameter <i>AG 50W-X2</i>
L66	A crown ether coated on a 5µm particle size silica gel substrate. The active site is (S)-18-crown-6-ether <i>CROWNPAK CR(+)</i>
L67	Porous vinyl alcohol copolymer with a C18 alkyl group attached to the hydroxyl group of the polymer, 2 to 10µm in diameter <i>Asahipak ODP-50 apHera C18</i>
L68	Spherical, porous silica, 10µm or less in diameter, the surface of which has been covalently modified with alkyl amide groups and not endcapped <i>Suplex pKb-100</i>
L69	Ethylvinylbenzene/divinylbenzene substrate agglomerated with quaternary amine functionalised 130nm latex beads, about 6.5µm in diameter <i>CarboPac PA20</i>
L70	Cellulose tris(phenyl carbamate) coated on 5µm silica <i>CHIRALCEL OC-H</i>
L71	A rigid, spherical polymethacrylate, 4 to 6µm in diameter <i>Shodex RSpak DE</i>

HPLC Column Selection by USP Specifications (continued)

L72	(S)-phenylglycine and 3,5-dinitroaniline urea linkage covalently bonded to silica <i>Sumichiral OA-3300 S</i>
L73	A rigid, spherical polydivinylbenzene particle, 5 to 10µm in diameter <i>Jordi-Gel DVB</i>
L74	A strong anion-exchange resin consisting of a highly cross-linked core of 7µm macroporous particles having a 100Å average pore size and consisting of ethylvinylbenzene cross-linked with 55% divinylbenzene and an anion-exchange layer grafted to the surface, which is functionalised with alkyl quaternary ammonium ions <i>IonPac AS14A</i>
L75	A chiral-recognition protein, bovine serum albumin (BSA), chemically bonded to silica particles, about 7µm in diameter, with a pore size of 300Å <i>RESOLVOSIL BSA</i>
L76	Silica based weak cation-exchange material, 5µm in diameter. Substrate is surface polymerised polybutadiene-maleic acid to provide carboxylic acid functionalities. Capacity not less than 29 µEq/column <i>IonPac SCS-1</i>
L77	Weak cation-exchange resin consisting of ethylvinylbenzene, 55% cross-linked with divinylbenzene copolymer, 6 to 9µm diameter. Substrate is surface grafted with carboxylic acid functionalised groups. Capacity not less than 500 µEq/column (4mm x 25cm) <i>IonPac CS17</i>
L78	A silane ligand that consists of both reversed-phase (an alkyl chain longer than C8) and anion-exchange (primary, secondary, tertiary or quaternary amino) functional groups chemically bonded to porous, non-porous or ceramic microparticles, 1.0 to 50µm in diameter or a monolithic rod <i>Acclaim Mixed-Mode WAX-1</i>
L79	A chiral-recognition protein, human serum albumin (HSA), chemically bonded to silica particles, about 5µm in diameter <i>CHIRALPAK HSA</i>
L80	Cellulose tris(4-methylbenzoate)-coated, porous spherical silica particles, 5µm in diameter <i>CHIRALCEL OJ-H</i>
L81	A hydroxide-selective, strong anion-exchange resin consisting of a highly cross-linked core of 9µm porous particles having a pore size of 2000Å and consisting of ethylvinylbenzene cross-linked with 55% divinylbenzene with a latex coating composed of 70nm diameter microbeads (6% cross-linked) bonded with alkanol quaternary ammonium ions <i>IonPac AS11-HC</i>
L82	Polyamine chemically bonded to cross-linked polyvinyl alcohol polymer, 4-5µm in diameter <i>Asahipak NH2P-40 Asahipak NH2P-50</i>
L83	A hydroxide-selective, strong anion-exchange resin, quaternary amine bonded on latex particles attached to a core of 10.5µm microporous particles having a pore size of 10Å and consisting of ethylvinylbenzene cross-linked with 55% divinylbenzene <i>IonPac AS17-C</i>
L84	Weak cation-exchange resin consisting of ethylvinylbenzene, 55% cross-linked with divinylbenzene copolymer, 5µm diameter. Substrate is surface grafted with carboxylic acid functionalised groups. Capacity not less than 8400 µEq/column (5mm x 25cm) <i>IonPac CS16</i>

USP and EP Allowable Adjustments

Allowable adjustments that can be made to a USP or EP (European Pharmacopoeia) method, without the method requiring revalidation, are summarised in the table below. Please contact us for further advice and assistance.

Parameter	USP ¹ Allowable Adjustment	EP ² Allowable Adjustment
Column Length	±70%	±70%
Column i.d.	±25%	±25%
Particle Size	-50%	-50%
Column Temperature	±10°C	±10°C
Flow Rate	±50%	±50%
Eluent pH	±0.2 units	±0.2 units
Concentration of Buffer Salts	±10%	±10%
Solvent A:B Ratio	Minor ±30% relative, but ≤±10% absolute	Minor ±30% relative or ±2% absolute, ≤ ±10% absolute for other
Injection Volume	Any reduction	Any reduction
Change of UV Detector Wavelength	0, but ±3nm between detectors	No change

¹ United States Pharmacopoeia 34 (2011) Section 621

² European Pharmacopoeia 6.0 (2010) Section 2.2.4.6

- ACE HPLC and ACE Excel® UHPLC options
- Ultra high purity base deactivated silica
- 2, 3, 5, 10 and 15µm particle sizes
- Unique selectivity phases
- Exceptional reproducibility
- Capillary to preparative dimensions

The ACE® range of ultra pure silica phases is manufactured by Advanced Chromatography Technologies Ltd (ACT). A wide range of particle sizes, pore sizes, bonded chemistries and column dimensions are available. Excellent performance and reproducible chromatography with basic, acidic and neutral molecules are ensured by the most stringent of validation protocols. ACE Excel® columns (see page 65), with increased pressure rating, are available for UHPLC applications in 2, 3 and 5µm particle sizes.

ACE Phases

Phase	Functional Group	Endcapped	Particle Size (µm)	Pore Size (Å)	Surface Area (m ² /g)	Carbon Load (%)	USP Listing
SuperC18	Octadecyl encapsulated	Yes	2, 3, 5, 10	90	400	14.8	L1
C18-AR	Octadecyl with integral Phenyl	Yes	2, 3, 5, 10	100	300	15.5	L1
C18-PFP	Octadecyl with integral PFP	Yes	2, 3, 5, 10	100	300	14.3	L1
C18-Amide	Octadecyl with integral amide polar group	Yes	2, 3, 5, 10	100	300	16.4	L1/L60
C18-HL	Octadecyl	Yes	3, 5, 10, 15	90	400	20.0	L1
C18	Octadecyl	Yes	2, 3, 5, 10	100	300	15.5	L1
C8	Octyl	Yes	2, 3, 5, 10	100	300	9.0	L7
C4	Butyl	Yes	2, 3, 5, 10	100	300	5.5	L26
CN-ES	Cyano with proprietary extended alkyl spacer	Yes	2, 3, 5, 10	100	300	12.6	L10
CN	Cyano	Yes	2, 3, 5, 10	100	300	5.5	L10
Ph	Phenyl	Yes	2, 3, 5, 10	100	300	9.5	L11
AQ	Proprietary	Yes	2, 3, 5, 10	100	300	14.0	L1
SIL	Unbonded	-	2, 3, 5, 10	100	300	-	L3
C18-300	Octadecyl	Yes	3, 5, 10	300	100	9.0	L1
C8-300	Octyl	Yes	3, 5, 10	300	100	5.0	L7
C4-300	Butyl	Yes	3, 5, 10	300	100	2.6	L26
CN-300	Cyano	Yes	3, 5, 10	300	100	2.6	L10
Ph-300	Phenyl	Yes	3, 5, 10	300	100	5.3	L11

Wide Range of Stationary Phase Selectivities

Selectivity is an important consideration for method development. Although changing organic modifier, buffer pH, gradient time etc. will all change retention times and therefore compound resolution, the column stationary phase is the feature which affects selectivity the greatest. In order to successfully separate compounds with wide variations in hydrophobicity and polarity, a number of phases with significantly different selectivity and which separate according to very different interaction mechanisms, are required.

The ACE range of phases, which now includes several novel chemistry phases, was developed in order to offer the chromatographer a wider choice of interaction mechanisms for method development. For instance, the unique ACE C18-AR and ACE C18-PFP phases offer C18, combined with Phenyl or PFP selectivities respectively, but exhibit the ultra low bleed and excellent temperature and pH stability characteristics of C18 phases.

Figure 1 demonstrates the power of selectivity in developing a method for the separation of a mixture of 7 components. In this case, using the combination of hydrophobic, π - π , dipole-dipole and shape selectivity interactions of the ACE C18-PFP column, all 7 components were fully resolved. In addition, comparing the results obtained with columns of significantly different selectivity for an unknown sample, can give confidence that all components which may be present in the mixture are detected.

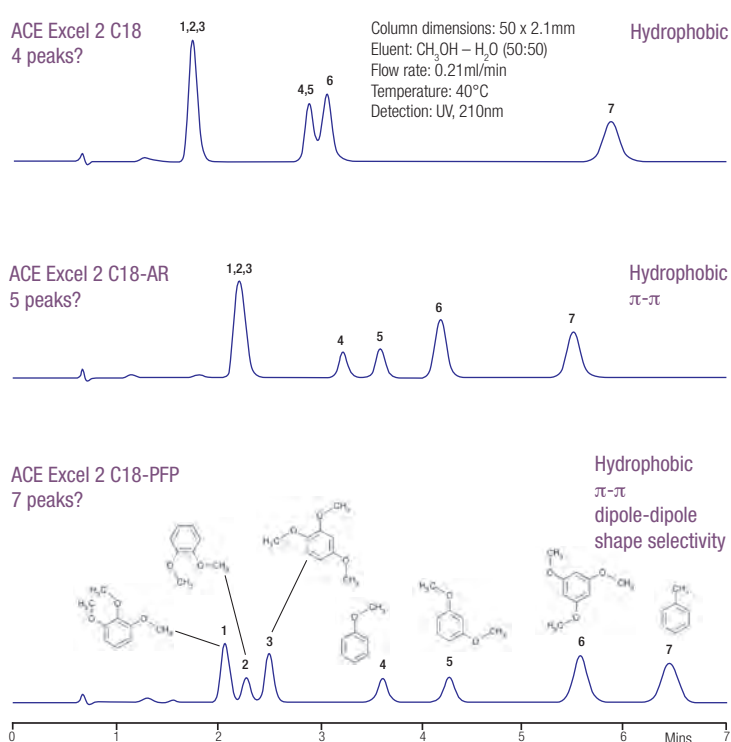
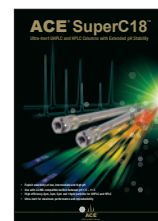

Figure 1. The power of stationary phase selectivity

ACE® SuperC18™

- Exploit selectivity at low, intermediate and high pH
- Use with LC-MS compatible buffers between pH 1.5 and 11.5
- Ultra low bleed for LC-MS compatibility
- Encapsulated Bonding Technology (EBT™) for improved stability
- Ideal for method development and screening
- Useful for preparative separations at high pH



Please request your copy of the ACE SuperC18 brochure

ACE® SuperC18™ is a new highly inert stationary phase developed by Advanced Chromatography Technologies Ltd. It is ideal for investigating selectivity at low, intermediate and high pH due to its excellent robustness and extended pH range. This phase can be used in both methanol and acetonitrile containing eluents, offers rapid re-equilibration and is ideal for method development and screening systems. ACE SuperC18 is also an ideal phase for purification and isolation work at high eluent pH. All ACE SuperC18 analytical dimension columns are supplied in the dual compatible UHPLC/HPLC Excel hardware (see page 65).

Encapsulated Bonding Technology

The unique Encapsulated Bonding Technology (EBT) developed for ACE SuperC18 columns considerably increases ligand coverage of the silica surface and effectively eliminates the effect of unbonded silanol groups from separations. This higher ligand coverage results in improved inertness, chromatographic performance and stability.

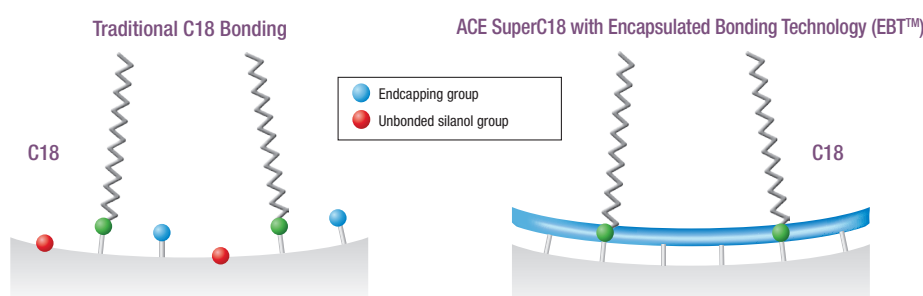

Under aggressive acidic conditions ACE SuperC18 is highly resistant to ligand cleavage, due to a combination of the Encapsulated Bonding Technology and ultra-inert ACE silica. Many C18 bonded columns however, will exhibit ligand cleavage under such acidic conditions, resulting in retention shifts and/or peak tailing.

Under basic conditions with LC-MS compatible eluents, the Encapsulated Bonding Technology shields the ACE SuperC18 from dissolution, whilst maintaining excellent chromatographic performance. Traditional C18 bonded silica columns however, are prone to silica dissolution under such aggressive conditions, which can result in premature column deterioration.

Exploiting Selectivity by Adjusting pH

Figure 2 illustrates the differences in selectivity that can be obtained for a mixture of compounds when using the ACE SuperC18 at low pH (3.0) and high pH (10.7). Changes in retention and elution order were observed. In addition to offering a powerful tool for method development, analysis at high and low pH on the same column allows the chromatographer to ensure that all components in a mixture are observed, with no coelution occurring.

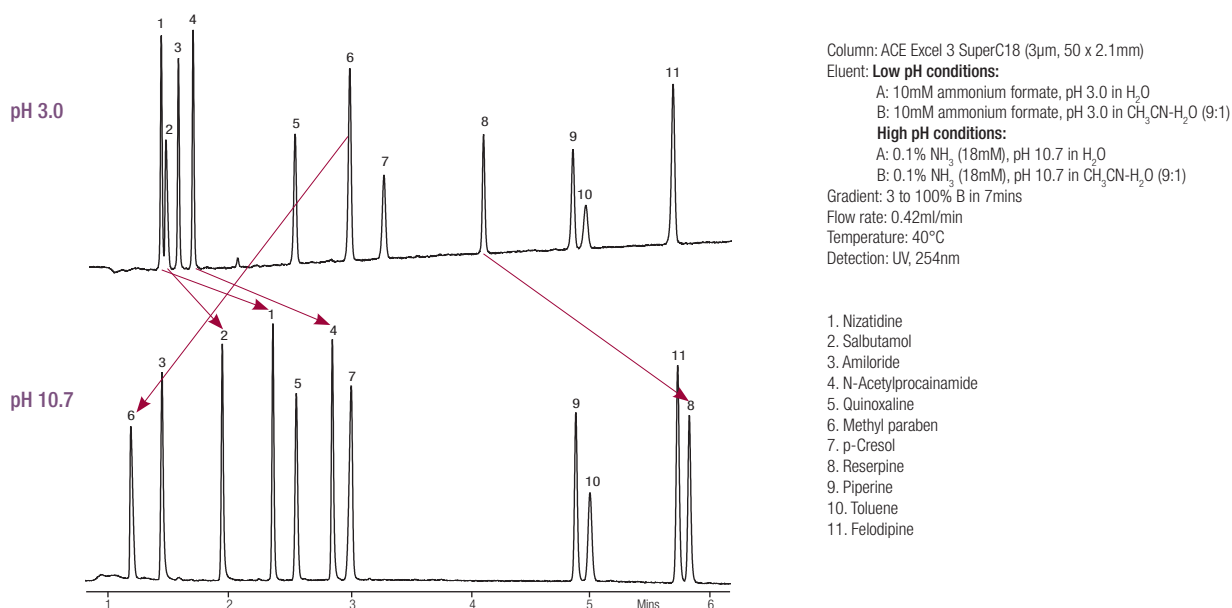
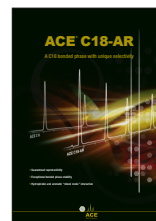

Figure 2. Selectivity at low and high pH

Please see pages 71-72 for ordering information for ACE SuperC18 columns.

ACE® C18-AR

- C18 bonded phase with integral phenyl (AR) selectivity
- Provides alternative selectivity to standard C18 columns
- Compatible with highly aqueous eluents
- Ultra low bleed phase for UV and LC-MS compatibility
- Exceptional bonded phase stability for elevated temperature applications
- USP L1 designation



Please request your copy of the ACE C18-AR brochure

Alternative Selectivity

C18 columns manufactured from high purity silicas show near identical selectivity. Therefore, simply changing from one leading C18 brand to another will not significantly improve a problematic separation. ACE® C18-AR, however, is a C18 phase that has been specifically developed to provide alternative selectivity to other C18 columns.

The ACE C18-AR phase utilises a specially developed ligand combining a C18 chain with integral phenyl functionality, thus combining the benefits of both C18 and phenyl characteristics into a single phase. ACE C18-AR can be used for 'standard' C18 column separations, but is additionally recommended for separations that involve compounds containing aromatic functionality.

In addition to strong hydrophobic interactions, ACE C18-AR exhibits strong π - π and moderate dipole-dipole interactions, with a moderate degree of shape selectivity. This makes the phase particularly suitable for the analysis of analytes containing π -bonding, different dipole moments or electron delocalization and electron withdrawing groups, such as halogens, nitro groups, ketones, esters and acids.

Figure 3 compares the selectivity offered by ACE 3 C18 (typical of conventional C18 phases) and ACE 3 C18-AR for a mixture containing aromatic nitrobenzene compounds. Hydrophobic retention of a neutral molecule marker is the same on both columns. However, selectivity towards the aromatic compounds is significantly enhanced, with increased retention and a complete reversal of elution order.

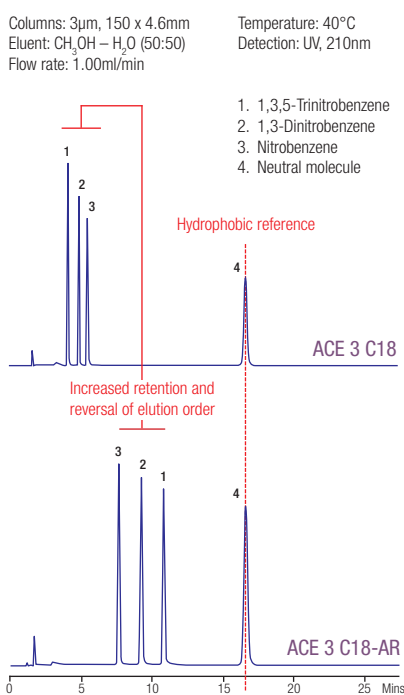

Figure 3. Aromatic nitrobenzenes

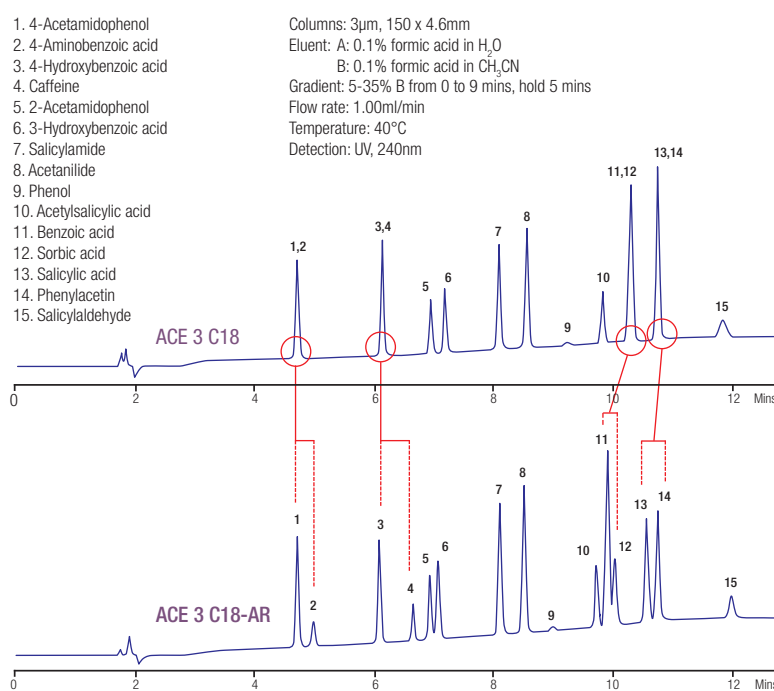

Figure 4. Analgesics separation

Figure 4 compares the separation of a mixture of 15 analgesics on ACE 3 C18 and ACE 3 C18-AR columns, under the same analytical conditions. Whereas on the ACE C18 column, 4 pairs of co-eluting peaks were observed, with ACE C18-AR all 15 components were resolved. This demonstrates the alternative selectivity offered by the ACE C18-AR phase, due to the presence of strong π - π and moderate dipole-dipole interactions, in addition to the hydrophobic interactions due to the C18 ligand.

Compatibility with High Aqueous Conditions

The integral phenyl functionality of the ACE C18-AR phase protects against de-wetting and subsequent retention loss, which may occur with conventional C18 phases when separating very polar, water-soluble compounds under highly aqueous (>95%) eluent conditions. As a result, ACE C18-AR produces highly reproducible chromatography even under highly aqueous conditions.

Very Low Bleed for UV and LC-MS Compatibility

Whereas most high purity C18 bonded phases show low bleed characteristics, alternative bonded phases such as phenyl and polar embedded phases, can exhibit significantly higher bleed, which is particularly evident at low UV wavelengths or by LC-MS. In contrast, ACE C18-AR shows very low column bleed, comparable to that observed for C18 phases.

Please see pages 71-72 for ordering information for ACE C18-AR columns.

ACE® C18-PFP

- Combines C18 and PFP separation mechanisms
- Improved retention of polar basic compounds
- Compatible with highly aqueous eluents
- Ultra low bleed phase for UV and LC-MS compatibility
- Exceptional bonded phase stability for elevated temperature applications
- USP L1 designation

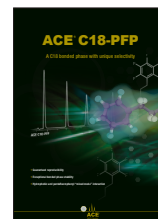

Please request your copy of the ACE C18-PFP brochure

ACE® C18-PFP is the second of the unique selectivity phases developed by ACT as an alternative to conventional C18 phases. In recent years the use of PFP bonded phases (see page 41) has grown significantly due to the alternative selectivity offered. However, compared to C18 phases, PFP phases have traditionally been compromised with reduced hydrophobicity, reduced stability and significant column bleed. The ACE C18-PFP phase utilises a specially developed ligand combining a C18 chain with integral PFP functionality. This results in a phase that maintains the hydrophobic, stability and low bleed characteristics of leading C18 phases, yet provides the multiple retention mechanisms of a PFP phase.

ACE C18-PFP Separation Mechanisms

The ACE C18-PFP phase exhibits multiple retention mechanisms including hydrophobic, π - π interactions, dipole-dipole interactions, hydrogen bonding and shape selectivity. Whilst approximations of relative strengths are shown in the table adjacent, the predominance of each retention mechanism is dictated by the solute's physico-chemical properties, its structure and the chromatographic conditions employed.

Separation Mechanism	C18	PFP	ACE C18-PFP
Hydrophobicity	++++	+ / ++	++++
π - π Interaction	-	+++	+++
Dipole-Dipole Interaction	-	++++	++++
Hydrogen Bonding	-	+++	+++
Shape Selectivity	++	+++	++++

Very Low Bleed for UV and LC-MS Compatibility

Whereas most high purity C18 bonded phases show low bleed characteristics, alternative bonded phases including PFP exhibit significantly higher bleed. This is particularly evident at low UV wavelengths or by LC-MS. ACE C18-PFP combines a low bleed level (typical of leading C18 brands) with an alternative selectivity, thus providing a valuable method development tool. Figure 5 shows the TIC trace obtained for ACE C18-PFP compared with a blank run, demonstrating that the ACE C18-PFP column has very low bleed and is therefore highly suitable for LC-MS analyses.

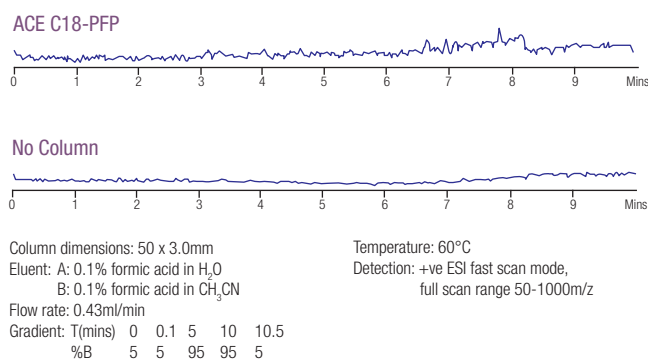

Figure 5. Low column bleed for LC-MS

Applications of ACE C18-PFP

Due to their similar hydrophobic characteristics, ACE C18-PFP columns may be used for applications in which 'standard' C18 columns would normally be considered. However, due to its integral pentafluorophenyl functionality, ACE C18-PFP is additionally recommended for separations that involve halogenated aromatic compounds, regioisomers and those analytes with differing shape constraints. Figure 6 demonstrates excellent resolution of all components in a mixture of methoxybenzene isomers when using an ACE C18-PFP column. Analysed on an ACE C18 column (typical of conventional C18 phases), two pairs of components coeluted, but on an ACE C18-PFP column all peaks were resolved. The neutral molecule marker had the same retention time on both columns due to hydrophobic interactions.

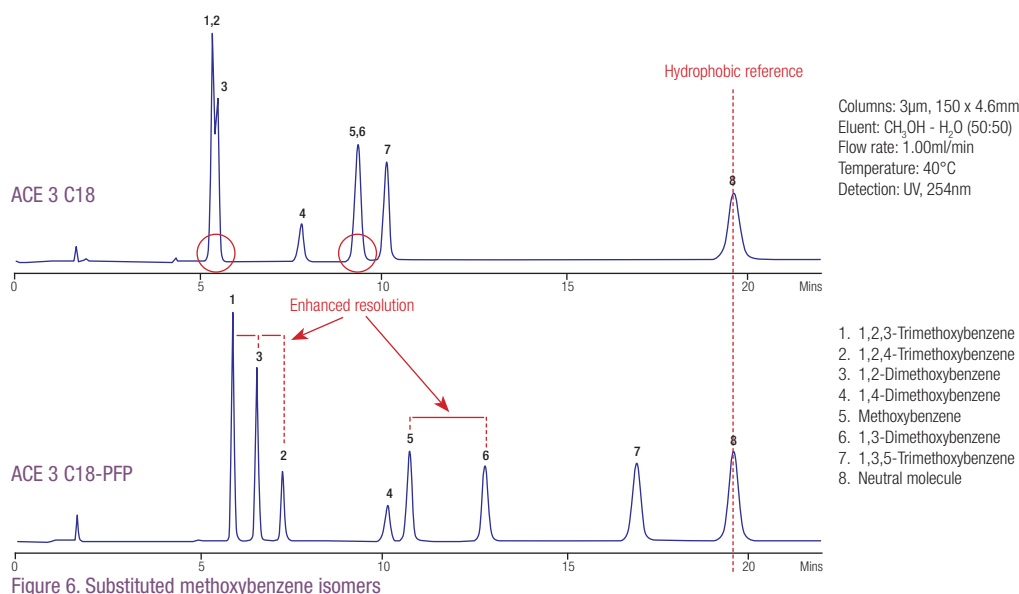

Figure 6. Substituted methoxybenzene isomers

Please see pages 71-72 for ordering information for ACE C18-PFP columns.

ACE® C18-Amide

- Offers combined C18 and Amide separation mechanisms
- Alternative selectivity to C18 for method development
- Improved separations of polar, acidic, basic and phenolic compounds
- Compatible with 100% aqueous eluents
- Low bleed for UV and LC-MS compatibility



Please request your copy of the ACE C18-Amide brochure

ACE® C18-Amide combines a C18 with a polar amide group on a single ligand. The extended spacer technology leads to increased column lifetime and stability. The ACE C18-Amide phase offers complementary selectivity to C18 columns due to multiple modes of interaction from the unique C18-Amide ligand, leading to increased polar retention. Figure 7 illustrates the difference between two ACE bonded phases, C18-Amide and C18. Although both phases offer the possibility of strong hydrophobic interaction with their respective C18 chains, the embedded amide group of the C18-Amide phase introduces additional modes of interaction, which results in increased retention for polar compounds and alternative selectivity.

ACE Excel 3 C18-Amide

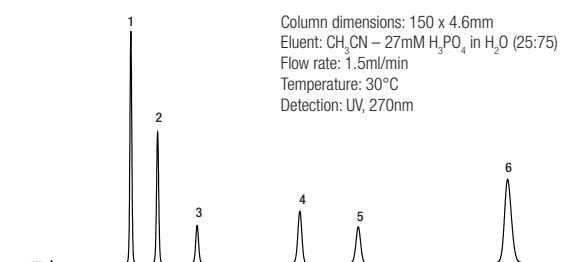

Column: ACE Excel 3 C18-Amide (3µm, 250 x 2.1mm)
Eluent: 40mM NH₄H₂PO₄ in H₂O, pH 2.5
Flow rate: 0.21ml/min
Temperature: 25°C
Detection: UV, 214nm

1. Oxalic acid
2. Tartaric acid
3. Malic acid
4. Lactic acid
5. Ascorbic acid
6. Citric acid

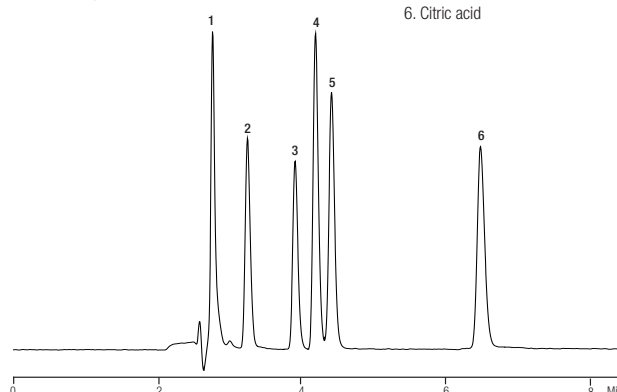

ACE Excel 3 C18

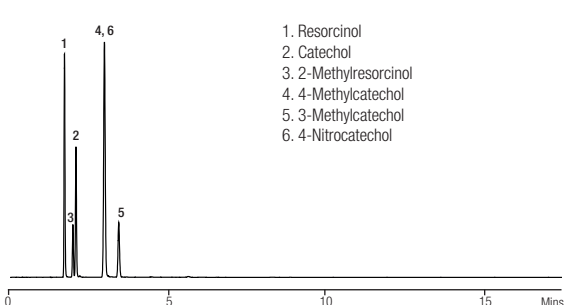

Figure 7. Enhanced selectivity with ACE C18-Amide

Figure 8. Separation of organic wine acids

Figure 8 demonstrates the separation of polar organic wine acids on ACE C18-Amide using a 100% aqueous eluent.

Figure 9 shows an example of the alternative selectivity obtained for vanillins using ACE C18-Amide compared with ACE C18.

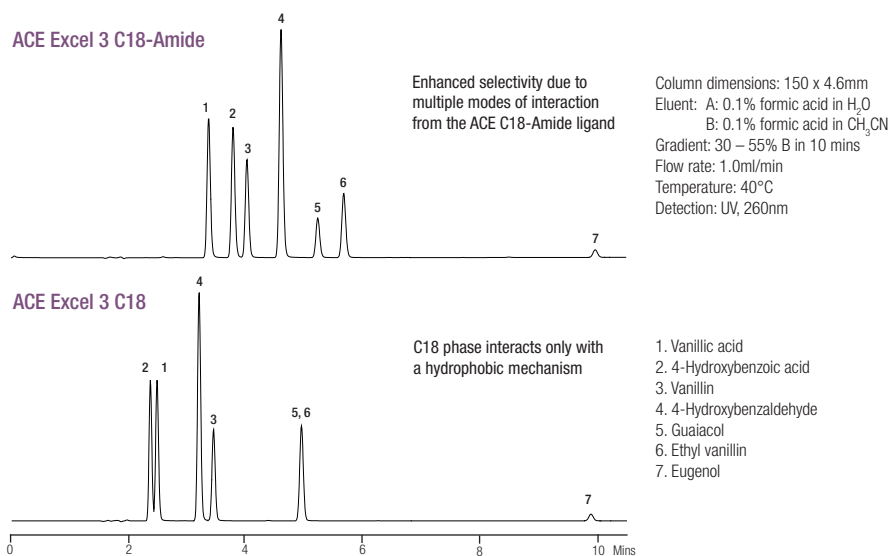

Figure 9. Separation of vanillins

All ACE C18-Amide analytical dimension columns are supplied in the dual compatible UHPLC/HPLC Excel hardware (see page 65).

Please see pages 71-72 for ordering information for ACE C18-Amide columns.

ACE® CN-ES

- Combines CN polar selectivity with enhanced hydrophobicity
- Alternative polar selectivity for method development
- Separations due to hydrophobic and dipole-dipole interactions
- Suitable for RP and NP separations
- Compatible with 100% aqueous eluents

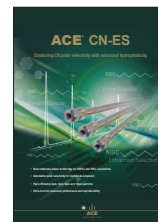

Please request your copy of the ACE CN-ES brochure

ACE® CN-ES combines a polar CN group with an extended spacer that provides increased hydrophobic retention. Separations are achieved by a combination of strong dipole-dipole interactions and hydrophobic binding interactions. The extended spacer technology additionally provides increased column lifetime and stability, compared to traditional CN bonded phases.

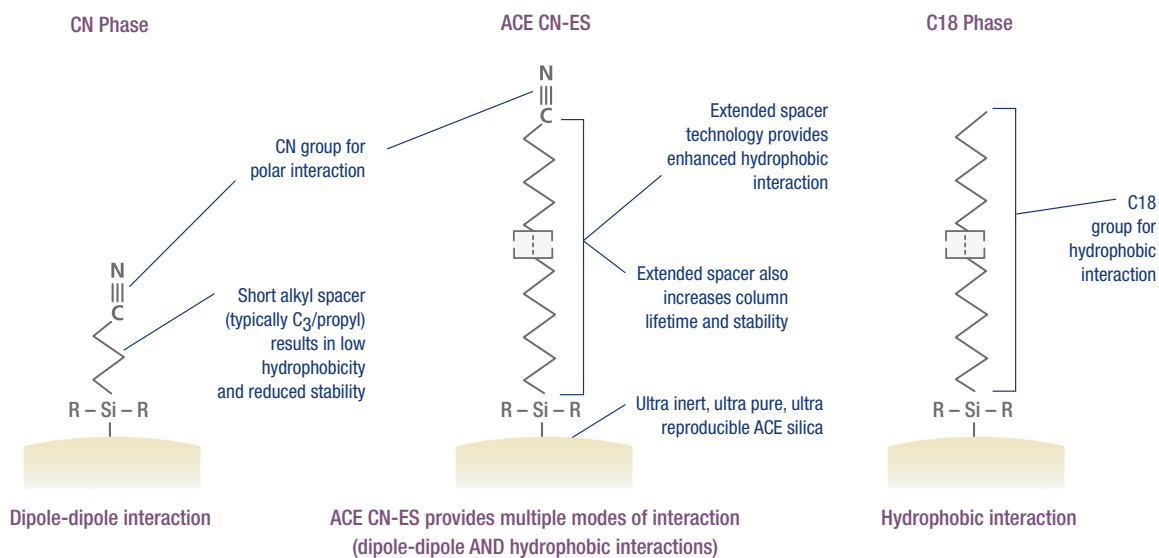

ACE CN-ES is recommended for separations where traditional CN bonded phases show insufficient stability or column lifetime or for applications where a typical C18 column does not provide adequate separation. ACE CN-ES also shows good selectivity for the separation of analytes with double and triple bonds and for mixtures of polar and non-polar analytes. Figure 10 shows how alternative selectivity can be exploited for the UHPLC separation of steroids. Whereas both the ACE Excel 2 C18 and the ACE Excel 2 CN columns fail to separate all nine components of this mixture, the ACE Excel 2 CN-ES column shows complete resolution of all compounds.

All ACE CN-ES analytical dimension columns are supplied in the dual compatible UHPLC/HPLC Excel hardware (see page 65).

Please see pages 71-72 for ordering information for ACE CN-ES columns.

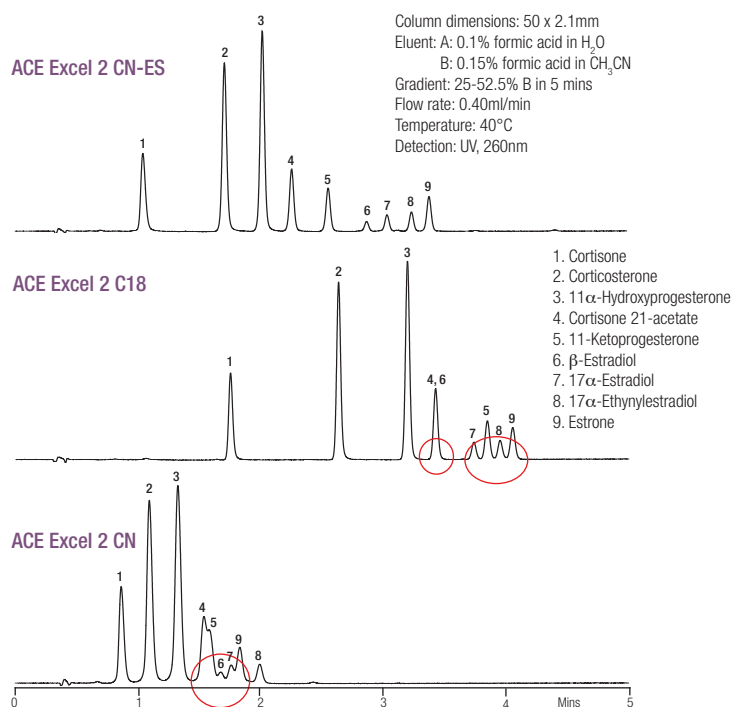

Figure 10. Selectivity comparison for UHPLC of Steroids

ACE® AQ

- Retains polar compounds in 100% aqueous eluent
- C18 bonded phase with integral polar functionality
- Resistant to retention loss in 100% aqueous eluent
- Rapid gradient re-equilibration
- Excellent peak shape with acidic, basic and neutral molecules
- Ideal for LC-MS applications

ACE® AQ is an ultra-inert phase designed for the reversed-phase separation of very polar compounds with up to 100% aqueous eluent. ACE AQ is ideal for use with fast gradients due to its rapid re-equilibration properties and resistance to retention loss.

Maximum Reproducibility in High Aqueous Eluents

When separating very polar, water-soluble compounds, highly aqueous (>95%) eluents are often required to achieve sufficient retention. However, operating a C18 column under such conditions can lead to dewetting or 'phase collapse' which can result in poor chromatographic reproducibility. Over time peaks will elute with shorter and shorter retention times and resolution between peaks will deteriorate. ACE AQ columns introduce an integral polar functionality, which prevents this retention loss when using highly aqueous eluents.

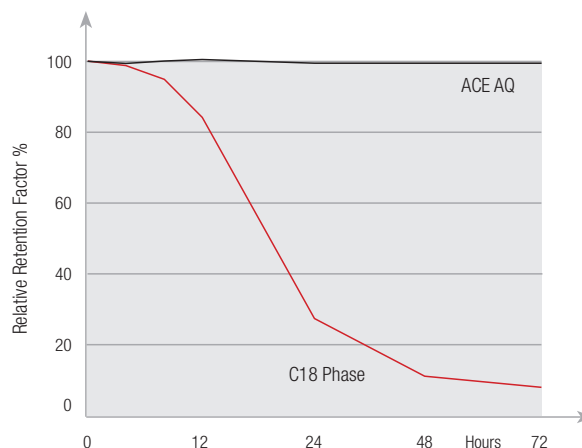

Figure 11. Change in retention with 100% aqueous eluent.*

*The comparative data presented here may not be representative for all applications.

ACE C18-HL (Hi-Load)

- High surface area, high carbon load phase
- Increased loading and retention
- Optimised for preparative and process scale applications

The increased retention characteristics of ACE C18-HL make it an ideal selection for LC-MS applications. Retention can be maintained whilst reducing the aqueous content of the eluent, thus increasing sensitivity. For preparative applications, the higher surface area leads to increased loading capacity. Available in 3, 5, 10 and 15µm particle sizes and a wide range of column dimensions, ACE C18-HL columns show reproducible scale-up from LC-MS to preparative scale dimensions.

ACE Guard Cartridges

- Protection of columns from 1.0 to 50mm i.d.
- No loss in column performance or selectivity
- Significantly extends column lifetime
- Available for all phases and dimensions

ACE guard cartridges are available for every ACE HPLC phase and column dimension to ensure maximum column protection for all applications. ACE analytical columns (2.1 to 4.6mm i.d.) are available with an integral zero dead volume guard holder, which also allows simple cartridge replacement. Compared to conventional 'stand alone' designs, this zero dead volume holder provides improved system efficiency, especially with 2.1mm i.d. columns.

Please note that these integral holders cannot be used with ACE Excel UHPLC columns. For protection of ACE Excel UHPLC columns, ACE UHPLC pre-column filters (see page 66) are recommended.

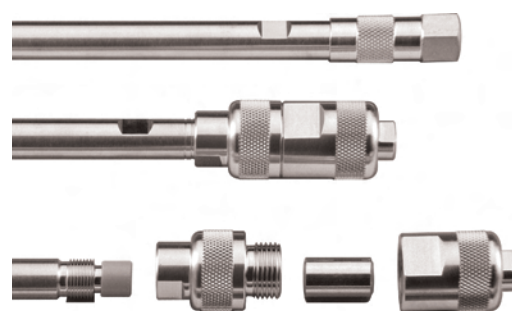

ACE integral zero dead volume guard holder (H0005) attached to a 4.6mm i.d. column



Please contact Hichrom to request a copy of the ACE Application Guide containing over 100 applications

ACE® Excel® UHPLC Columns

- 2, 3 and 5µm particle size columns available
- Unique phases for rapid method development
- Compatible with UHPLC and HPLC systems
- HSC™ (High Stability Columns): ultra robust up to 1,000 bar (15,000psi)
- Optimised UHPLC hardware

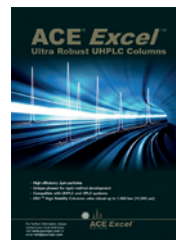

Please request your copy of the ACE Excel UHPLC columns brochure

ACE® Excel® 2µm particle size columns offer all the advantages of ACE HPLC columns but in a format suitable for UHPLC. Selectivity is unchanged from existing 3, 5 and 10µm ACE HPLC phases, enabling excellent scale-up of methods. Excellent peak shape, great column-to-column reproducibility and exceptional column ruggedness is now available for UPLC® and UHPLC users. All ACE Excel UHPLC columns are manufactured using a proprietary HSC™ (High Stability Column) manufacturing process that results in ultra robust UHPLC columns. ACE Excel columns utilize specially developed low dispersion hardware which enables high efficiency UHPLC separations up to a maximum pressure limit of 1,000 bar (15,000psi).

Compatible with all UPLC and UHPLC Systems

ACE Excel UHPLC columns are designed to be fully compatible with all commercial UPLC and UHPLC instruments and have been engineered to benefit from the high flow rate, ultra-high pressure and low dispersion of these systems.

Owing to the optimal 2µm particle size and a rigorous classification protocol, column back pressure is significantly lower than for traditional UPLC and UHPLC columns packed with <2µm particles. Therefore ACE Excel 2µm columns may also be used on HPLC systems to provide a performance boost compared to standard HPLC columns, subject to HPLC system pressure limitations.

Figure 12 illustrates the excellent peak shapes and resolution obtained during rapid UHPLC screening of 16 pharmaceuticals and related compounds on an ACE Excel 2µm C18 column in less than 5 minutes.

Reusable UHPLC column connectors EXL-CC (see page 66) are recommended for UHPLC connections and offer ultra low dead volume connections.

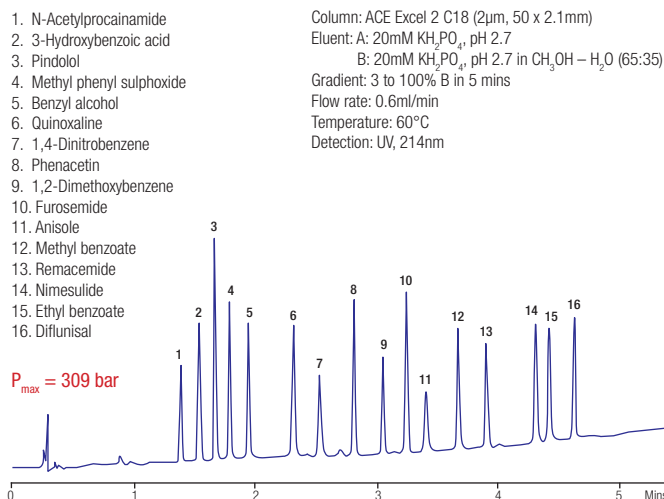

Figure 12. Rapid UHPLC screening

Unique Selectivity Phases

In addition to the wide range of standard ACE phases (C18, C8, C4, CN, Phenyl, AQ and SIL), the benefits of the extra selectivity offered by the unique phases ACE C18-AR, ACE C18-PFP, ACE C18-Amide, ACE CN-ES and ACE SuperC18 (see pages 59-63), are now also available for UHPLC applications. These alternative selectivity 2µm phases complement the standard ACE Excel phases, providing chromatographers with increased choice for method development. Figure 13 shows the different selectivity obtained using three ACE Excel columns (C18, C18-AR and C18-PFP) for a mixture of pharmaceuticals and related compounds. Whereas the ACE Excel 2µm C18 column (typical of other leading UHPLC C18 columns) fails to resolve all the components under these conditions, the unique selectivity of both the ACE Excel C18-AR and C18-PFP phases enable improved separations. In total ACE Excel columns are now available in 12 phases.

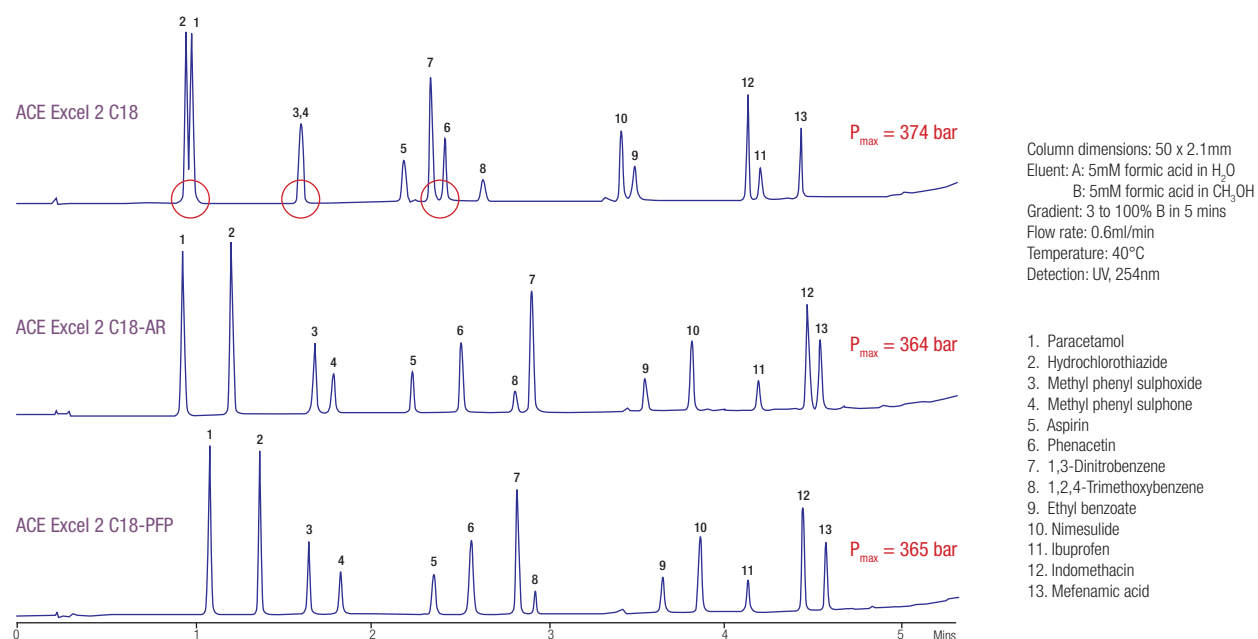

Figure 13. Alternative selectivity for UHPLC separations*

*The comparative separations presented here may not be representative for all applications.

Please see pages 71-72 for ordering information for ACE Excel columns.

ACE® Excel® UHPLC Columns (continued)

Column-to-Column Reproducibility

Like all ACE columns, ACE® Excel UHPLC columns are subjected to extensive controls at each stage of the manufacturing process. In addition to the HSC™ packing technology used to manufacture ACE Excel® UHPLC columns, they incorporate an inlet frit design that reduces the risk of plugging. It is still recommended that you filter samples and eluents as you would with any UHPLC column, but ACE Excel columns provide the same levels of durability and lifetime that you would expect from HPLC columns.

Figure 14 illustrates the excellent lifetime and reproducibility provided by an ACE Excel C18 column under searching fast gradient UHPLC conditions. After over 2,000 gradient cycles incorporating a P_{max} of 1,000 bar (15,000psi), the column efficiency, peak shape and retention times were essentially unchanged.

Easy scalability from UHPLC to HPLC to preparative HPLC

All ACE Excel columns are available in larger particle size equivalents and larger non-analytical dimensions. The consistent selectivity inherent in all ACE stationary phases, regardless of particle size, permits easier transfer of methods from UHPLC to HPLC or HPLC to UHPLC. It also makes scale-up from analytical to preparative applications easier.

ACE Excel 2 C18 – Start

Column: ACE Excel 2 C18 (2 μ m, 100 x 2.1mm)
 Eluent: A: 0.1% formic acid in H₂O
 B: 0.1% formic acid in CH₃OH
 Gradient: 20% to 90% B in 6 mins, 1 min hold,
 90% to 20% B in 1 min, 2 mins re-equilibration hold
 Flow rate: 0.73ml/min
 P_{max} : 1,000 bar (15,000psi)

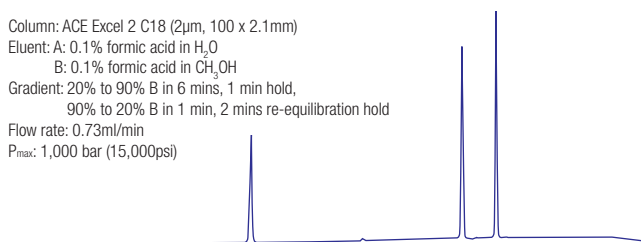

ACE Excel 2 C18 – After 2,000 fast gradient cycles

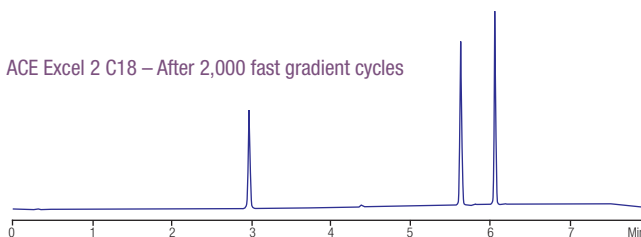
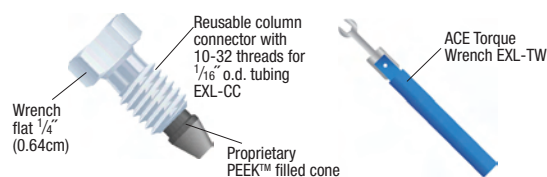

Figure 14. Exceptional durability of ACE Excel UHPLC columns

ACE UHPLC Reusable Column Connector

- Pressure rating >1700 bar (>25,000psi)
- Compatible with all UHPLC systems
- Compatible with all UHPLC column brands
- Eliminates poor connections
- Unique reusable design

ACE UHPLC column connectors are reusable and enable UHPLC columns to be correctly installed every time. Their unique design ensures that they maintain pressure rating with repeated use, yet do not permanently swage onto the inlet tubing. This has the advantage of avoiding the introduction of extra column volume to the system and minimising leaks at the inlet fitting connection. To maximize the lifetime of the fitting, the use of an ACE Torque Wrench (EXL-TW) is required. Standard ACE HPLC PEEK fingertight connectors (ACE-CC, pressure rated to 350 bar/5,000psi) may be used at the outlet end of the UHPLC column, where pressure demands are lower but a correct connection remains important.



Please contact Hichrom for your copy of the 'Making Good Connections' flyer

ACE Pre-column Filters

Pre-column filters may be used to protect the column inlet frit from blockage and extend column lifetime. Due to their ultra-low dispersion design, column performance and retention remain unaffected.



ACE UHPLC Pre-column filter

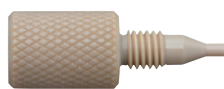

ACE Microbore HPLC Pre-column filter



ACE Analytical HPLC Pre-column filter

ACE UHPLC Pre-column Filters

ACE UHPLC Pre-column filters are designed for use in UHPLC separations requiring high eluent velocities and ultra-high pressure. ACE UHPLC Pre-column filters (p/n EXL-PCF10, 10/pk) can be installed on any UHPLC column in seconds and are leak tight to 1000 bar. Simply finger tighten initially, then wrench tighten a further 1/4 turn. For connection to a Waters Acquity system, the use of a pre-column filter incorporating the Waters Acquity column port profile is alternatively recommended (p/n EXL-PCF10/ACQ, 10/pk).

ACE HPLC Pre-column Filters

ACE HPLC Pre-column filters utilise a PEEK fingertight design that connects directly into any 1/16" 10-32 internal thread column inlet, and are thus compatible with all HPLC brands.

For 2.1mm i.d. HPLC columns, the use of ACE Microbore HPLC Pre-column filters is recommended. For 3.0 - 4.6mm i.d. HPLC columns, the use of ACE Analytical HPLC Pre-column filters is recommended.

ACE HPLC Pre-column filters are simply hand tightened into the column inlet to achieve a pressure rating of 350 bar (5000psi). If higher pressure rating is required, ACE UHPLC Pre-column filters are alternatively recommended.

Please see page 71 for ordering information for ACE Excel columns and ACE UHPLC column connectors, and page 73 for ACE Pre-column filters

ACE® 300Å Columns for Biotechnology

- 300Å ultra high purity silica
- Ultimate protein and peptide application column
- C18, C8, C4, CN and Phenyl chemistries
- 3, 5 and 10µm particle sizes
- Exceptional chemical stability

ACE® 300Å pore size columns produce high efficiency, reproducible separations for a wide range of peptides, proteins and other high molecular weight biomolecules. They are available in an extensive range of dimensions and particle sizes for use in micro-scale separations, LC-MS analyses and analytical and preparative scale analyses.

Increased Sensitivity

TFA is typically used as an eluent additive to improve both peak shape and resolution of complex mixtures of peptides and proteins. However, although TFA complexation with polypeptides can enhance selectivity, mass spectral sensitivity is decreased. ACE 300Å phases maintain good separation characteristics even when using reduced levels of TFA, leading to increased sensitivity of detection. Figure 15 demonstrates that for the separation of a peptide mixture, with an ACE 5 C18-300 column, performance is maintained when TFA concentration is decreased down to 0.005%.

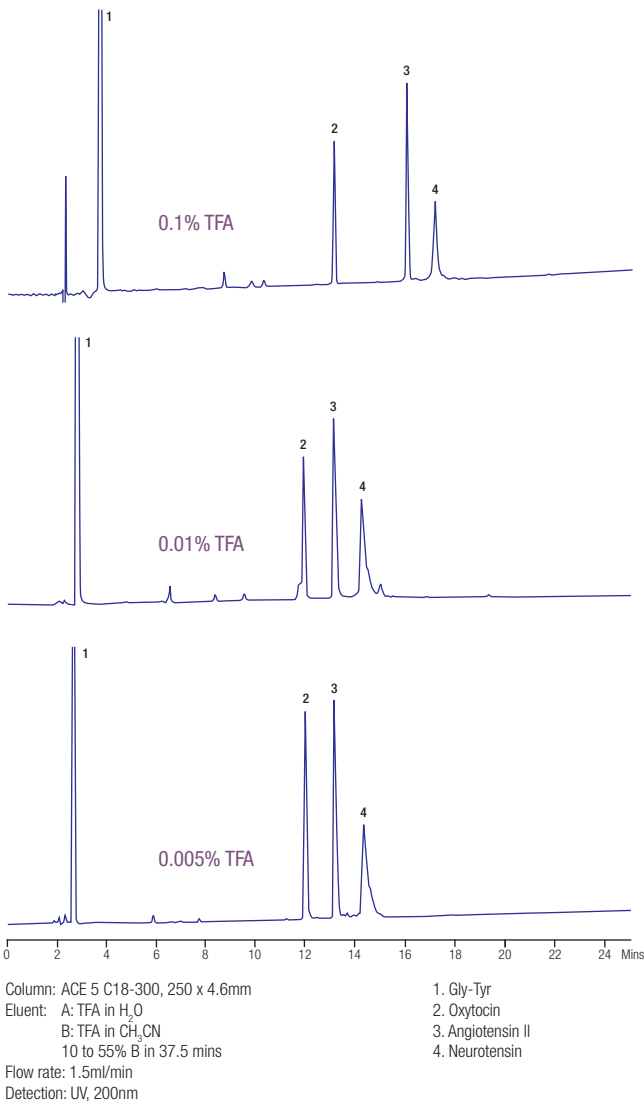

Figure 15. Separation of peptide mix

Optimising Selectivity

The ability of TFA and other eluent additives to complex with peptides and proteins can be used to adjust selectivity and improve resolution. As shown in Figure 16, lowering TFA concentration from 0.1% to 0.01% enabled the resolution of angiotensin II and III on an ACE 5 C18-300 column.

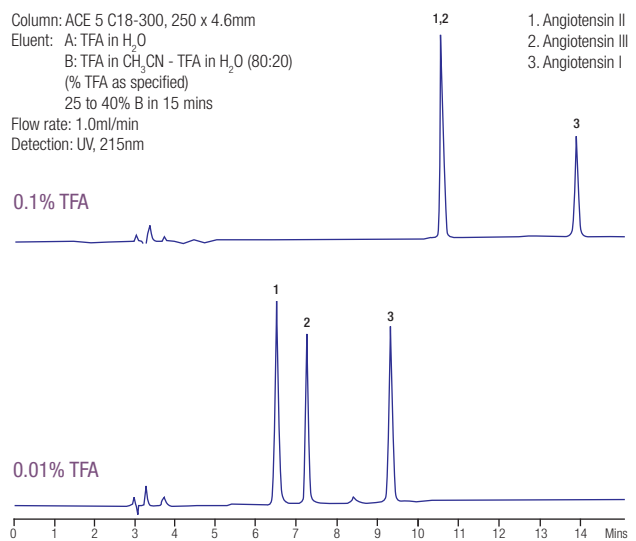

Figure 16. Selectivity as a function of TFA concentration

Figure 17 shows the separation of whey proteins from milk on an ACE C4-300 column.

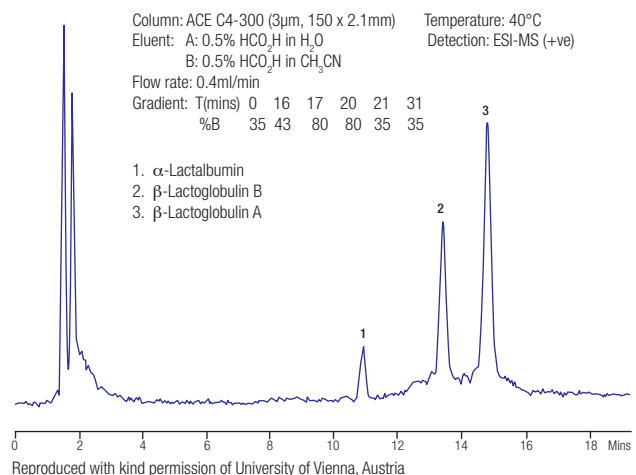

Figure 17. Whey proteins from whole milk

Part numbers for ACE 300Å columns are listed on pages 72-73.

ACE® LC-MS Columns

- High performance – excellent peak shape for higher sensitivity
- Wide range of bonded phases available
- Ultra-inert silica enables MS compatible buffers to be used
- 20, 30, 35 and 50mm column lengths

The use of truly ultra-inert base deactivated HPLC columns is imperative for high-throughput analysis or LC-MS. Even subtle differences in silanol activity between columns can markedly affect the chromatography in the very short, fast columns typically used. Any peak tailing due to silanol activity can have a profound effect on detection limits in high sensitivity assays. ACE® ultra-inert base deactivated HPLC columns virtually eliminate the negative effects of silanols in HPLC separations and are ideal for LC-MS applications.

In Figure 18, the chromatograms show the LC-MS signal intensity obtained for equivalent injections on an ultra-inert ACE 30 x 4.6mm i.d. C8 column and a C8 column with less inert silica. The expanded chromatograms show that there is almost perfect symmetry (virtually no baseline tailing) with the ACE column.

Increased Column Robustness

ACE LC-MS and rapid analysis columns are manufactured by a unique process which results in increased column bed stability, thus increasing column lifetime.

LC-MS Buffer Compatibility

ACE columns, by virtue of their high bonding density and ultra-inert characteristics, can be used with eluent conditions that are optimal for LC-MS applications. ACE LC-MS columns have an extremely low requirement for buffer salts or modifiers in order to achieve good peak shape. ACE columns have been demonstrated to be extremely robust at high and low pH. For maximum LC-MS compatibility under acidic conditions, organic acids such as formic and acetic are recommended. Under basic conditions ammonium bicarbonate, ammonium acetate and ammonium hydroxide buffers are recommended. Figure 19 demonstrates the resolution obtained with 2 basic compounds at different eluent pHs on an ACE 3 C18 column. For extra high and low pH conditions ACE SuperC18 columns are recommended (see page 59).

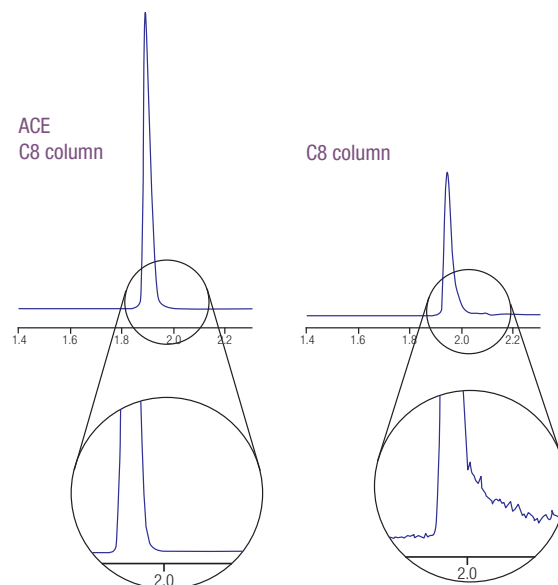

Figure 18. Effect of peak tailing on signal strength in LC-MS*

*The comparative separations presented here may not be representative for all applications.

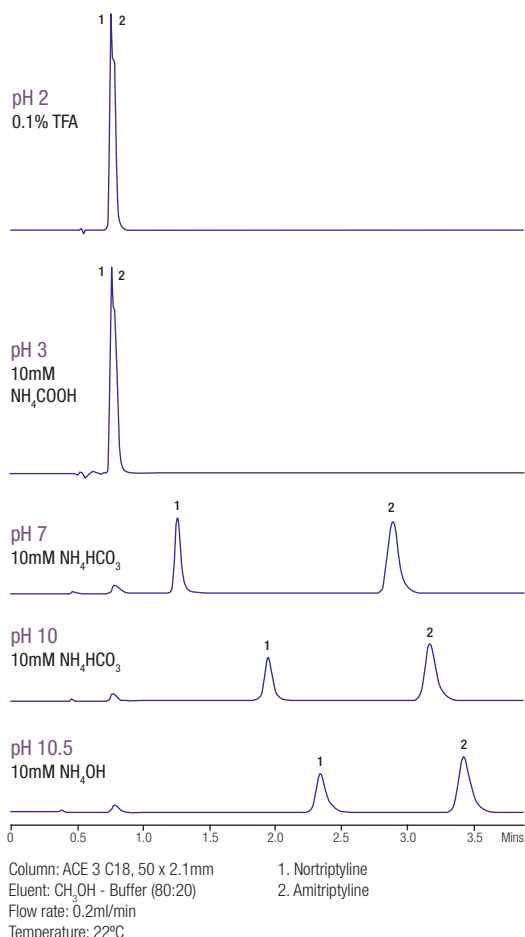
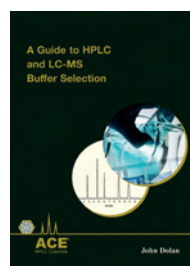

Figure 19. pH investigation with LC-MS buffers



Please contact Hichrom
for a copy of the
LC-MS Buffer Guide

ACE® Capillary and Nano Columns

- Capillary (500 and 300µm) and nano (100 and 75µm) dimensions
- Wide range of bonded phases available
- 100Å and 300Å pore sizes
- High efficiency, long lifetime and guaranteed reproducibility
- LC-MS and LC-MS/MS applications

In addition to the extensive range of analytical (1.0 – 4.6mm i.d.) through to preparative (21.2 – 50mm i.d.) columns, ACE® columns are available in capillary (500 and 300µm) and nano (100 and 75µm) dimensions. ACE capillary and nano columns are available with all ACE bonded phase chemistries in 90Å, 100Å and 300Å pore sizes.

Improved Mass Limit of Detection

Capillary and nano HPLC are advantageous for applications where limited sample amounts lead to problems in detection sensitivity. This is relevant in the areas of pharmacokinetics, trace analysis and in particular the expanding fields of bioanalytical and proteomic analysis. ACE capillary and nano columns are ideal for use with detectors requiring very low flow rates, such as electrospray LC-MS.

ACE capillary and nano HPLC columns offer high sensitivity due to their low dispersion characteristics. Table 1 shows the theoretical sensitivity increase of each i.d. column compared with a 4.6mm i.d. analytical column and 1.0mm i.d. microbore column. This high sensitivity can be important for accurate quantitation of sample limited applications.

For maximum performance, these columns should be used with fully optimised HPLC systems (e.g. minimise system dead volume by using short lengths of <75µm i.d. connection tubing).

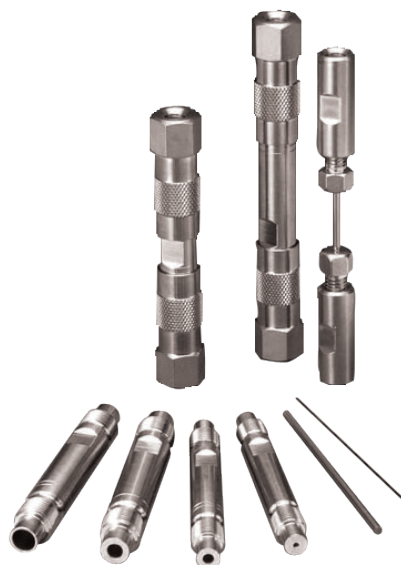

Table 1. Sensitivity Increase

Column i.d. (mm)	Typical Flow Rate (µl/min)	Theoretical Sensitivity Increase ¹
4.6	1000	1
1.0	40	21
0.5	10	85
0.3	3	235
0.1	0.5	2100
0.075	0.3	3760

¹ For same sample mass

ACE Trace Enrichment/Guard Columns

Capillary HPLC guard columns (5mm x 300µm or 500µm i.d.) prolong the lifetime of the capillary column. They are also suitable for trace enrichment and column switching applications, particularly for concentration of low abundance analytes or desalting of biological samples. These short columns can be used to separate analyte from matrix prior to analysis with detectors such as ESI-MS, where baseline resolution is not required. Figure 20 shows the connection of an ACE capillary column to a guard cartridge using a capillary column coupler.

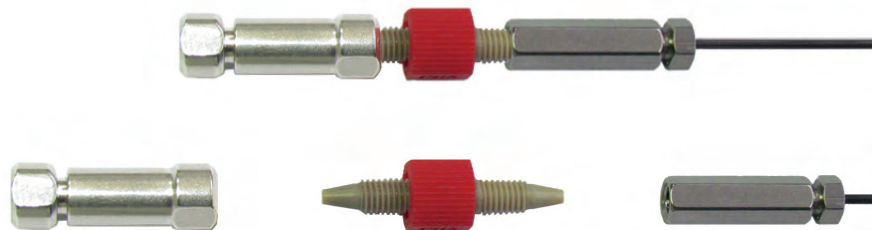

Figure 20. ACE capillary column, guard and connector (C0003)

ACE Capillary and Nano Column Availability

ACE capillary and nano columns are available with all bonded phase chemistries, 90Å, 100Å or 300Å pore sizes and 3, 5 or 10µm particle sizes.

Please see pages 71 and 72 for ordering information.

ACE® Preparative HPLC Columns

- Ultra high purity base deactivated silica
- 5, 10 and 15µm particle sizes available
- Fully validated columns
- Exceptional reproducibility
- Excellent efficiencies
- High sample recovery
- Excellent column lifetime
- 90Å, 100Å and 300Å pore sizes

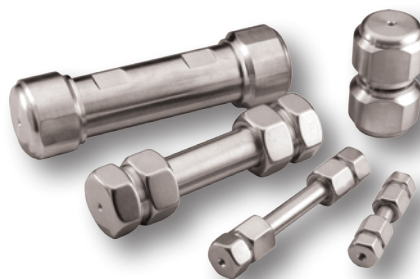

Achieve Reproducible High Performance Preparative Separations

For preparative HPLC, resolution and loadability are of the utmost importance. The greater the resolution, the higher the sample load and the faster pure compound is obtained. The ability to optimise resolution at the preparative scale means starting with high performance separations at the analytical scale. The same features that make ACE® ultra-inert base deactivated analytical columns the choice of method development chemists, also make them the ideal choice for scale-up and process methods.

ACE preparative HPLC columns offer the following benefits:

- 1) **Loadability** – high surface area and carbon load for maximum sample capacity
- 2) **Selectivity** – available in unbonded and 12 bonded phases, including ACE SuperC18 and all ACE 'extra selectivity' phases, to optimise resolution and maximise sample capacity
- 3) **Rugged** – reliable, long-term performance
- 4) **Guaranteed reproducibility** – complete column/batch validation as for ACE analytical columns
- 5) **Guard cartridges** – available for maximum column protection

Get High Purity Product Fast

ACE preparative HPLC columns are available in a wide range of column dimensions and particle sizes. For maximum loadability, choose 30mm i.d. columns. Use a 50mm length column with a 5µm particle size to optimise the speed of your separation. To maximise resolution, choose a 250mm length column with a 5µm particle size.

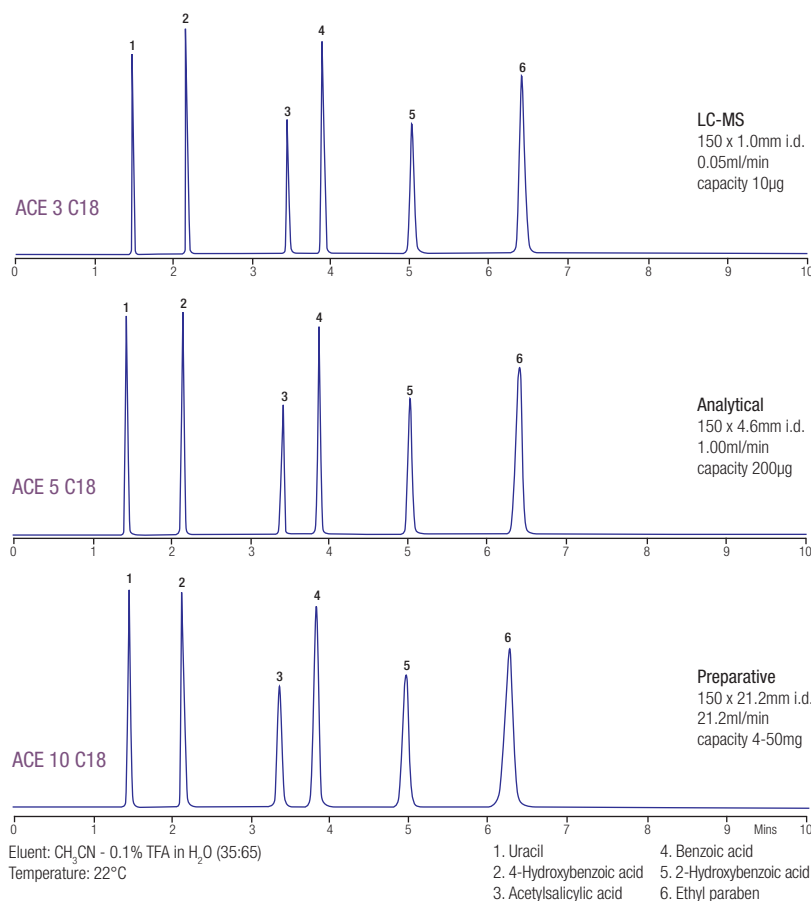

Figure 21. Reproducible scale-up with ACE C18 columns

Part numbers for ACE preparative columns are listed on pages 71-73.

Ordering Information – ACE® Columns

ACE Excel 2µm UHPLC Columns - when ordering please replace 'X' with the appropriate material code.

ACE Excel UHPLC columns also available with 3 and 5µm particle size – please enquire for further details

ACE Excel 2µm Phase	C18	C8	C4	CN	Phenyl	AQ
X	EXL-101	EXL-102	EXL-103	EXL-104	EXL-105	EXL-106
ACE Excel 2µm Phase	SIL	C18-AR	C18-PFP	SuperC18	C18-Amide	CN-ES
X	EXL-107	EXL-109	EXL-1010	EXL-1011	EXL-1012	EXL-1013

Example: For a 50 x 2.1mm i.d. ACE Excel 2µm C18 UHPLC column – Catalogue No. = EXL-101-0502U

Column Diameter	Column Length (mm)								UHPLC Reusable Connector ^{1,2,3}
	20	30	35	50	75	100	125	150	
2.1mm	X -0202U	X -0302U	X -3502U	X -0502U	X -7502U	X -1002U	X -1202U	X -1502U	EXL-CC
3.0mm	X -0203U	X -0303U	X -3503U	X -0503U	X -7503U	X -1003U	X -1203U	X -1503U	EXL-CC
4.6mm	X -0246U	X -0346U	X -3546U	X -0546U	X -7546U	X -1046U	X -1246U	X -1546U	EXL-CC

¹ Also available as 10/pk - EXL-CC10

² Torque Wrench (EXL-TW) is recommended

³ Starter kit available (EXL-CCSK) containing 4x EXL-CC plus 1x EXL-TW

ACE 3µm 100Å HPLC Columns - when ordering, please replace 'X' with the appropriate material code.

ACE Excel 3µm UHPLC columns also available – please enquire for details

ACE 3µm Phase	C18	C8	C4	CN	Phenyl	AQ	SIL
X	ACE-111	ACE-112	ACE-113	ACE-114	ACE-115	ACE-116	ACE-117
ACE 3µm Phase	C18-AR	C18-PFP	SuperC18	C18-Amide	CN-ES	C18-HL	-
X	ACE-119	ACE-1110	ACE-1111	ACE-1112	ACE-1113	ACE-311	-

Example: For a 150 x 4.6mm i.d. ACE 3 C18 HPLC column – Catalogue No. = ACE-111-1546

Column Diameter	Column Length (mm)									Guard Cartridges
	20	30	35	50	75	100	125	150	250	
75µm	-	-	-	-	-	X -1000075	-	X -1500075	-	-
100µm	-	-	-	-	-	X -10001	-	X -15001	-	-
300µm	-	X -03003	X -35003	X -05003	X -75003	X -10003	X -12003	X -15003	X -25003	X -005003GD ¹
500µm	-	X -03005	X -35005	X -05005	X -75005	X -10005	X -12005	X -15005	X -25005	X -005005GD ¹
1.0mm	-	X -0301	X -3501	X -0501	X -7501	X -1001	X -1201	X -1501	X -2501 ^a	X -0101GD ²
2.1mm	X -0202 ²	X -0302	X -3502	X -0502	X -7502	X -1002	X -1202	X -1502	X -2502 ^a	X -0102GD ³
3.0mm	X -0203 ²	X -0303	X -3503	X -0503	X -7503	X -1003	X -1203	X -1503	X -2503 ^a	X -0103GD ⁴
4.0mm	-	-	X -3504	X -0504	X -7504	X -1004	X -1204	X -1504	X -2504 ^a	X -0103GD ⁴
4.6mm	X -0246 ²	X -0346	X -3546	X -0546	X -7546	X -1046	X -1246	X -1546	X -2546 ^a	X -0103GD ⁴

¹ 1/pk – use with capillary column coupler C0003 – no holder required

² 5/pk – guards for 20mm length and 1.0mm i.d. columns require cartridge holder H0001 and coupler C0001

³ 5/pk – use with integral microbore cartridge holder H0004

⁴ 5/pk – use with integral analytical cartridge holder H0005

^a Available to special order - consider operating pressure limitations for maximum column lifetime

ACE 5µm 100Å HPLC Columns - when ordering please replace 'X' with the appropriate material code.

ACE Excel 5µm UHPLC columns also available – please enquire for details

ACE 5µm Phase	C18	C8	C4	CN	Phenyl	AQ	SIL
X	ACE-121	ACE-122	ACE-123	ACE-124	ACE-125	ACE-126	ACE-127
ACE 5µm Phase	C18-AR	C18-PFP	SuperC18	C18-Amide	CN-ES	C18-HL	-
X	ACE-129	ACE-1210	ACE-1211	ACE-1212	ACE-1213	ACE-321	-

Column Diameter	Column Length (mm)										Guard Cartridges
	20	30	35	50	75	100	125	150	250	300	
75µm	-	-	-	-	-	X -1000075	-	X -1500075	X -2500075	-	-
100µm	-	-	-	-	-	X -10001	-	X -15001	X -25001	-	-
300µm	-	X -03003	X -35003	X -05003	X -75003	X -10003	X -12003	X -15003	X -25003	X -30003	X -005003GD ¹
500µm	-	X -03005	X -35005	X -05005	X -75005	X -10005	X -12005	X -15005	X -25005	X -30005	X -005005GD ¹
1.0mm	-	X -0301	X -3501	X -0501	X -7501	X -1001	X -1201	X -1501	X -2501	-	X -0101GD ²
2.1mm	X -0202 ²	X -0302	X -3502	X -0502	X -7502	X -1002	X -1202	X -1502	X -2502	X -3002	X -0102GD ³
3.0mm	X -0203 ²	X -0303	X -3503	X -0503	X -7503	X -1003	X -1203	X -1503	X -2503	X -3003	X -0103GD ⁴
4.0mm	-	-	X -3504	X -0504	X -7504	X -1004	X -1204	X -1504	X -2504	X -3004	X -0103GD ⁴
4.6mm	X -0246 ²	X -0346	X -3546	X -0546	X -7546	X -1046	X -1246	X -1546	X -2546	X -3046	X -0103GD ⁴
7.75mm	-	-	-	X -0508	X -7508	X -1008	X -1208	X -1508	X -2508	X -3008	X -0110GD ⁵
10.0mm	-	-	-	X -0510	X -7510	X -1010	X -1210	X -1510	X -2510	X -3010	X -0110GD ⁵
21.2mm	-	-	-	X -0520	X -7520	X -1020	X -1220	X -1520	X -2520	X -3020	X -0110GD ⁵
30.0mm	-	-	-	X -0530	X -7530	X -1030	-	X -1530	X -2530	X -3030	X -0220GD ⁶

¹ 1/pk – use with capillary column coupler C0003 – no holder required

² 5/pk – guards for 20mm length and 1.0mm i.d. columns require cartridge holder H0001 and coupler C0001

³ 5/pk – use with integral microbore cartridge holder H0004

⁴ 5/pk – use with integral analytical cartridge holder H0005

⁵ 3/pk – use with semi-prep cartridge holder H0002 and column coupler C0001

⁶ 1/pk – use with prep cartridge holder H0006 and column coupler C0002

Ordering Information – ACE® Columns (continued)

ACE 10µm 100Å HPLC Columns - when ordering please replace 'X' with the appropriate material code.

ACE 10µm Phase	C18	C8	C4	CN	Phenyl	AQ	SIL
X	ACE-131	ACE-132	ACE-133	ACE-134	ACE-135	ACE-136	ACE-137
ACE 10µm Phase	C18-AR	C18-PFP	SuperC18	C18-Amide	CN-ES	C18-HL	-
X	ACE-139	ACE-1310	ACE-1311	ACE-1312	ACE-1313	ACE-331	-

Column Diameter	Column Length (mm)										Guard Cartridges
	20	30	50	75	100	125	150	250	300	500	
4.6mm	X-0246 ²	X-0346	X-0546	X-7546	X-1046	X-1246	X-1546	X-2546	X-3046	X-5046	X-0103GD ⁴
7.75mm	-	-	X-0508	X-7508	X-1008	X-1208	X-1508	X-2508	X-3008	X-5008	X-0110GD ⁵
10.0mm	-	-	X-0510	X-7510	X-1010	X-1210	X-1510	X-2510	X-3010	X-5010	X-0110GD ⁵
21.2mm	-	-	X-0520	X-7520	X-1020	X-1220	X-1520	X-2520	X-3020	X-5020	X-0110GD ⁵
30.0mm	-	-	X-0530	X-7530	X-1030	-	X-1530	X-2530	X-3030	X-5030	X-0220GD ⁶
50.0mm	-	-	-	X-7550	X-1050	-	X-1550	X-2550	-	-	X-0220GD ⁶

² 5/pk – Guards for 20mm length and 1.0mm i.d. columns require cartridge holder H0001 and coupler C0001

⁴ 5/pk – Use with integral analytical cartridge holder H0005

⁵ 3/pk – Use with semi-prep cartridge holder H0002 and column coupler C0001

⁶ 1/pk – Use with prep cartridge holder H0006 and column coupler C0002

ACE 3µm 300Å HPLC Columns - when ordering please replace 'X' with the appropriate material code.

Phase Required	ACE 3 C18-300	ACE 3 C8-300	ACE 3 C4-300	ACE 3 CN-300	ACE 3 Phenyl-300
X	ACE-211	ACE-212	ACE-213	ACE-214	ACE-215

Column Diameter	Column Length (mm)										Guard Cartridges
	20	30	35	50	75	100	125	150	250		
75µm	-	-	-	-	-	X-1000075	-	X-1500075	-	-	
100µm	-	-	-	-	-	X-10001	-	X-15001	-	-	
300µm	-	X-03003	X-35003	X-05003	X-75003	X-10003	X-12003	X-15003	X-25003	X-005003GD ¹	
500µm	-	X-03005	X-35005	X-05005	X-75005	X-10005	X-12005	X-15005	X-25005	X-005005GD ¹	
1.0mm	-	X-0301	X-3501	X-0501	X-7501	X-1001	X-1201	X-1501	-	X-0101GD ²	
2.1mm	X-0202 ²	X-0302	X-3502	X-0502	X-7502	X-1002	X-1202	X-1502	-	X-0102GD ³	
3.0mm	X-0203 ²	X-0303	X-3503	X-0503	X-7503	X-1003	X-1203	X-1503	-	X-0103GD ⁴	
4.0mm	-	-	X-3504	X-0504	X-7504	X-1004	X-1204	X-1504	-	X-0103GD ⁴	
4.6mm	X-0246 ²	X-0346	X-3546	X-0546	X-7546	X-1046	X-1246	X-1546	-	X-0103GD ⁴	

¹ 1/pk – Use with capillary column coupler C0003 – no holder required

² 5/pk – Guards for 20mm length and 1.0mm i.d. columns require cartridge holder H0001 and coupler C0001

³ 5/pk – Use with integral microbore cartridge holder H0004

⁴ 5/pk – Use with integral analytical cartridge holder H0005

ACE 5µm 300Å HPLC Columns - when ordering please replace 'X' with the appropriate material code.

Phase Required	ACE 5 C18-300	ACE 5 C8-300	ACE 5 C4-300	ACE 5 CN-300	ACE 5 Phenyl-300
X	ACE-221	ACE-222	ACE-223	ACE-224	ACE-225

Column Diameter	Column Length (mm)										Guard Cartridges
	20	30	35	50	75	100	125	150	250		
75µm	-	-	-	-	-	X-1000075	-	X-1500075	X-2500075	-	
100µm	-	-	-	-	-	X-10001	-	X-15001	X-25001	-	
300µm	-	X-03003	X-35003	X-05003	X-75003	X-10003	X-12003	X-15003	X-25003	X-005003GD ¹	
500µm	-	X-03005	X-35005	X-05005	X-75005	X-10005	X-12005	X-15005	X-25005	X-005005GD ¹	
1.0mm	-	X-0301	X-3501	X-0501	X-7501	X-1001	X-1201	X-1501	X-2501	X-0101GD ²	
2.1mm	X-0202 ²	X-0302	X-3502	X-0502	X-7502	X-1002	X-1202	X-1502	X-2502	X-0102GD ³	
3.0mm	X-0203 ²	X-0303	X-3503	X-0503	X-7503	X-1003	X-1203	X-1503	X-2503	X-0103GD ⁴	
4.0mm	-	-	X-3504	X-0504	X-7504	X-1004	X-1204	X-1504	X-2504	X-0103GD ⁴	
4.6mm	X-0246 ²	X-0346	X-3546	X-0546	X-7546	X-1046	X-1246	X-1546	X-2546	X-0103GD ⁴	
7.75mm	-	-	-	X-0508	X-7508	X-1008	X-1208	X-1508	X-2508	X-0110GD ⁵	
10.0mm	-	-	-	X-0510	X-7510	X-1010	X-1210	X-1510	X-2510	X-0110GD ⁵	
21.2mm	-	-	-	X-0520	X-7520	X-1020	X-1220	X-1520	X-2520	X-0110GD ⁵	
30.0mm	-	-	-	X-0530	X-7530	X-1030	-	X-1530	X-2530	X-0220GD ⁶	

¹ 1/pk – Use with capillary column coupler C0003 – no holder required

² 5/pk – Guards for 20mm length and 1.0mm i.d. columns require cartridge holder H0001 and coupler C0001

³ 5/pk – Use with integral microbore cartridge holder H0004

⁴ 5/pk – Use with integral analytical cartridge holder H0005

⁵ 3/pk – Use with semi-prep cartridge holder H0002 and column coupler C0001

⁶ 1/pk – Use with prep cartridge holder H0006 and column coupler C0002

Ordering Information – ACE® Columns (continued)

ACE 10µm 300Å HPLC Columns - when ordering please replace 'X' with the appropriate material code.

Phase Required	ACE 10 C18-300	ACE 10 C8-300	ACE 10 C4-300	ACE 10 CN-300	ACE 10 Phenyl-300
X	ACE-231	ACE-232	ACE-233	ACE-234	ACE-235

Column Diameter	Column Length (mm)									Guard Cartridges
	20	30	35	50	75	100	125	150	250	
4.6mm	X -0246 ²	X -0346	X -3546	X -0546	X -7546	X -1046	X -1246	X -1546	X -2546	X -0103GD ⁴
7.75mm	-	-	-	X -0508	X -7508	X -1008	X -1208	X -1508	X -2508	X -0110GD ⁵
10.0mm	-	-	-	X -0510	X -7510	X -1010	X -1210	X -1510	X -2510	X -0110GD ⁵
21.2mm	-	-	-	X -0520	X -7520	X -1020	X -1220	X -1520	X -2520	X -0110GD ⁵
30.0mm	-	-	-	X -0530	X -7530	X -1030	-	X -1530	X -2530	X -0220GD ⁶

² Guards for 20mm columns require cartridge holder H0001 and column coupler C0001

⁴ 5/pk – Use with integral analytical cartridge holder H0005

⁵ 3/pk – Use with semi-prep cartridge holder H0002 and column coupler C0001

⁶ 1/pk – Use with prep cartridge holder H0006 and column coupler C0002

ACE UHPLC and HPLC Pre-column Filters

Description	Maximum Pressure	Pack Size	Part No.
ACE UHPLC Pre-column filter	1000 bar	1	EXL-PCF01
		10	EXL-PCF10
ACE Waters compatible UHPLC Pre-column filter	1000 bar	1	EXL-PCF01/ACQ
		10	EXL-PCF10/ACQ
ACE Microbore HPLC Pre-column filter for 2.1mm i.d. columns	350 bar	5	ACE-HP205
		10	ACE-HP210
ACE Analytical HPLC Pre-column filter for more typical standard bore (3.0 to 4.6mm i.d.) columns	350 bar	5	ACE-CS205
		10	ACE-CS210

ACE UHPLC and HPLC Method Development Kits

Method development kits enable the optimum bonded phase for an application to be identified. ACE columns are available with a unique range of highly selective phases in 2, 3, 5 and 10µm particle sizes, specially developed for challenging UHPLC and HPLC applications. The availability of a range of phases offering complementary selectivity enables resolution to be maximised, improves the chances of impurity detection and increases the speed at which methods can be systematically developed.

Please enquire for further details.



Please contact Hichrom
for a free copy of any ACE
technical guide

Daicel chiral HPLC columns are the most widely referenced chiral columns. Chiral Technologies, a subsidiary of Daicel Corporation, offers the complete range of Daicel chiral columns and has the largest portfolio of chiral stationary phases for the separation of racemic mixtures. This includes the CHIRALPAK®, CHIRALCEL® and CROWNPAK® trademarks. The wide range of polysaccharide chiral stationary phases (CSPs) can be divided into two distinct groups - modern immobilized phases and traditional, coated phases.

CHIRALPAK® Immobilized Phases

CHIRALPAK IA, IB, IC, ID, IE and IF HPLC and SFC columns are a newer generation of CSPs, in which the polysaccharide chiral selector has been immobilized on to a wide pore silica matrix. This confers universal solvent compatibility on these highly selective chiral phases, without compromising phase stability. In addition, the phases show increased robustness compared with traditional coated polysaccharide phases. Analytical and preparative dimension columns are available for each of these phases.

Chiral Selectors

CHIRALPAK IA - based on amylose *tris*(3,5-dimethylphenyl)carbamate (as in CHIRALPAK AD)
 CHIRALPAK IB - based on cellulose *tris*(3,5-dimethylphenyl)carbamate (as in CHIRALCEL OD)
 CHIRALPAK IC - based on cellulose *tris*(3,5-dichlorophenyl)carbamate
 CHIRALPAK ID - based on amylose *tris*(3-chlorophenyl)carbamate
 CHIRALPAK IE - based on amylose *tris*(3,5-dichlorophenyl)carbamate
 CHIRALPAK IF - based on amylose *tris*(3-chloro, 4-methylphenyl)carbamate

Column: CHIRALPAK IB (5µm, 250 x 4.6mm)
 Eluent: n-hexane - THF - EDA (70:30:0.1)
 Flow rate: 1ml/min

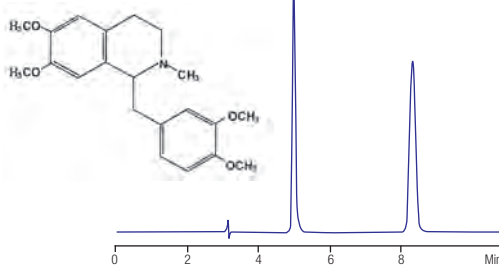

Figure 1. Analysis of laudanosine on CHIRALPAK IB

Features of Immobilized Phases

1) Wide Solvent Compatibility – The immobilization of the selector confers a wide solvent compatibility to these highly selective chiral stationary phases, without compromising phase stability. This is in contrast to traditional, coated polysaccharide phases which have restricted solvent compatibility due to solubility of the polymer coating in certain solvents, including chloroform, methylene chloride, ethyl acetate, acetone, THF and DMF.

2) Column Regeneration – CHIRALPAK immobilized columns are more robust than their coated analogues. If columns have been used with additives or with multiple solvent changes, a regeneration procedure may be implemented to eliminate any change in chiral recognition.

3) Screening Strategies – Column screening is simpler, faster and more successful using the four main Daicel immobilized phases (IA, IB, IC and ID). When used in alkane/alcohol solvents, the immobilized columns can separate a significant number of small molecules, combined with the advantage of speed and ease of injecting in any suitable solvent.

Polysaccharide Coated Phases

The original Daicel CSPs were formed by coating the chiral polymer from the derivatization of the amylose and cellulose on to 10µm silica. Subsequently, these CHIRALPAK AD and AS and CHIRALCEL OD and OJ phases were superseded by products made with higher efficiency 5µm particles. These CSPs are designated CHIRALPAK AD-H and AS-H and CHIRALCEL OD-H and OJ-H.

Reversed-phase versions of these 5µm normal-phase are also available. These include CHIRALPAK AD-RH and AS-RH and CHIRALCEL OD-RH and OJ-RH. These were specifically developed for use with aqueous-organic eluents. They are suited for applications where the sample is in aqueous media (eg. biological samples) or for samples that require flexibility in terms of pH range. More recently, 3µm particle size NP and RP phases have been introduced for higher resolution, fast analyses (CHIRALPAK AD-3, AD-3R, AS-3, AS-3R and CHIRALCEL OD-3, OD-3R, OJ-3, OJ-3R). These phases enable enhanced chromatographic separations to be achieved using conventional HPLC systems. Figure 2 demonstrates that enantiomer separation can be achieved in less than 30 seconds.

Column: CHIRALPAK AD-3
 (3µm, 50 x 4.6mm)
 Eluent: n-Hexane – 2-propanol – diethylamine
 (90:10:0.1)
 Flow rate: 5.0ml/min
 Detection: UV, 235nm

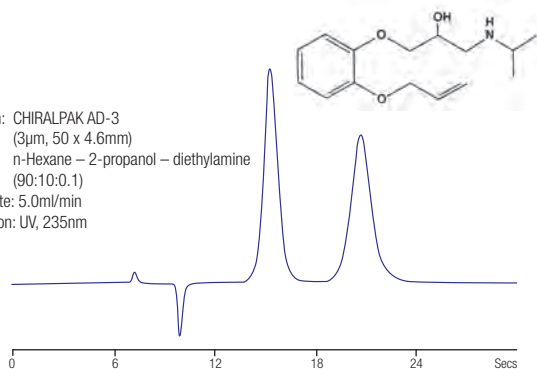

Figure 2. Fast analysis of oxprenolol on CHIRALPAK AD-3

Blue trace
 Column: CHIRALCEL OD-3 (2 x 150 x 4.6mm)
 Eluent: Hexane – IPA (97.5:2.5)
 Flow rate: 0.5ml/min

Red trace
 Column: CHIRALPAK AY-H (250 x 4.6mm)
 Eluent: Hexane – ethanol (95:5)
 Flow rate: 1ml/min

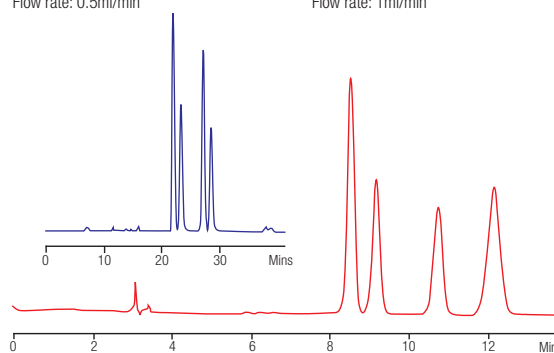

Figure 3. Separation of metolachlor diastereomers

Please contact us for ordering information on all Chiral Technologies products.

Newer Polysaccharide Coated Phases

CHIRALPAK® AY-H, AZ-H and CHIRALCEL® OZ-H, OX-H 5µm and CHIRALPAK AY-3, AZ-3 and CHIRALCEL OZ-3, OX-3 3µm HPLC and SFC columns contain significantly different chiral selectors to the immobilized and coated polysaccharide phases discussed on the previous page. They show new recognition profiles, allowing effective method development for compounds not fully resolved on other Daicel columns. Figure 3 (page 74) shows a comparison of the separation of the four diastereomers of the herbicide metolachlor using CHIRALPAK AY-H and CHIRALCEL OD-3.

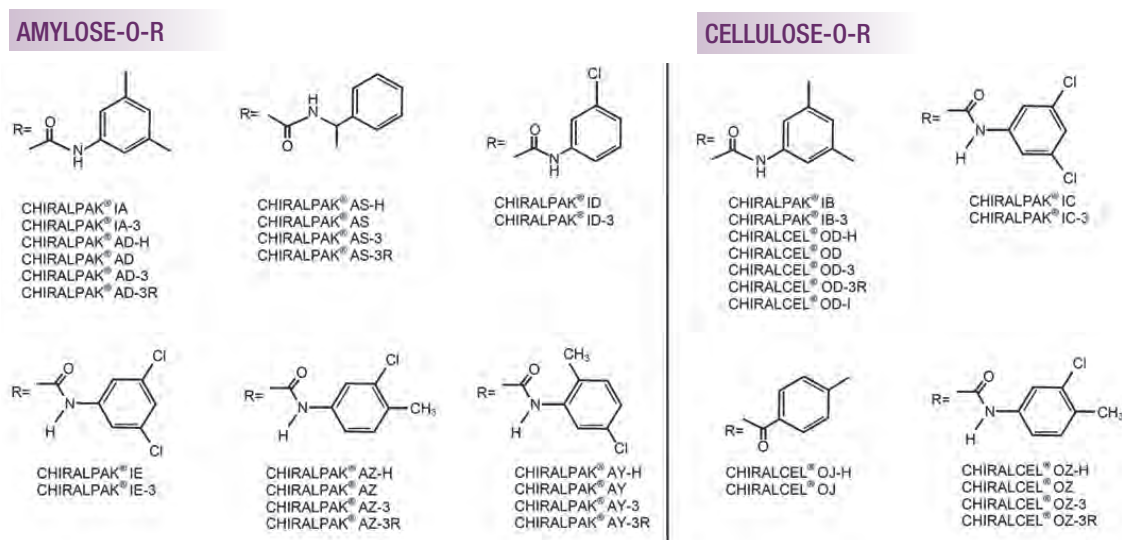

Figure 4. Structures of polysaccharide CSPs

Daicel Columns for SFC

Daicel polysaccharide columns are well established for use in SFC separations. In addition to the benefits of speed of separation, speed of method development and improved column efficiency, green SFC technology reduces the use of organic solvents. Columns packed specifically for SFC are available in both the immobilized and coated polysaccharide product lines.

CHIRALPAK Ion-Exchange Columns

A. CHIRALPAK QN-AX and QD-AX Anion-Exchange Columns

CHIRALPAK QN-AX and QD-AX are enantioselective weak anion-exchange (AX) columns. They are based on complementary stereoisomeric quinine (QN) and quinidine (QD) derivatives. Due to their pseudo enantiomeric character they usually reveal reversed elution order for opposite enantiomers. These phases are designed specifically for enantioselective HPLC of chiral acids and show exceptional separation capabilities for acidic chiral compounds containing carboxylic, phosphonic, phosphinic, phosphoric or sulphonic acid groups.

B. CHIRALPAK ZWIX™

The zwitterionic CHIRALPAK ZWIX(+) and ZWIX(-) stationary phases are quinine- and quinidine-derived chiral supports respectively that incorporate both anion- and cation-exchange functional groups. These novel selectors exhibit enantioselective separation capabilities toward zwitterionic molecules such as underivatized amino acids and peptides.

CHIRALPAK Protein Phase Columns

Protein stationary phases were originally developed and manufactured by ChromTech Ltd, but are now manufactured by Chiral Technologies Europe. The range consists of three protein-based columns – CHIRALPAK AGP, CHIRALPAK CBH and CHIRALPAK HSA (previously called CHIRAL-AGP, CHIRAL-CBH and CHIRAL-HSA), where the protein is immobilized on 5µm porous spherical silica particles. These columns are used with reversed-phase solvents, using buffers with low organic content and at moderate pH.

CHIRALPAK AGP has the broadest applicability of the three chiral phases, separating a wide range of compound types.

CHIRALPAK CBH has a narrower applicability, preferentially separating compounds containing one or more nitrogen atoms together with one or more hydrogen accepting or donating groups, and is particularly suited for the analysis of very hydrophilic amines.

CHIRALPAK HSA is also more suitable for specific applications, particularly very hydrophilic acids.

Crown Ether Chiral Columns

The CROWNPAK® CR(+) and CR(-) phases contain a chiral crown ether as chiral selector, which is coated on to a 5µm silica support. They can be used for the enantiomeric separation of amino acids and other small molecules containing a primary amino group near the chiral centre. The CR(-) column gives the reversed elution order compared to the CR(+) column. Acidic eluents such as perchloric acid at pH 1 to 2 are used as standard with these columns.

Ligand Exchange Chiral Columns

The ligand exchange phases, CHIRALPAK MA(+) and CHIRALPAK WH consist of amino acids and their derivatives coated on to silica supports. They are used in conjunction with an aqueous CuSO₄ eluent (0.1 to 2mM) and are useful for the separation of amino acids and their derivatives.

Please contact us for ordering information on all Chiral Technologies products.

- Spherical porous silica
- Monomeric and polymeric bonded C18
- Unique speciality bonded phases

Nacalai Tesque of Kyoto, Japan manufactures the COSMOSIL® range of columns. Their products include four C18 bonded phases and a number of unique speciality phases.

COSMOSIL Phases

Phase ²	Functional Group	Bonding	Particle Size (µm)	Pore Size (Å)	Surface Area (m ² /g)	Carbon Load (%)	Endcapping
SL-II	-	-	3, 5	120	300	-	-
C18-MS-II	Octadecyl	Monomeric	2.5 ¹ , 3, 5	120	300	16	Yes
C18-AR-II	Octadecyl	Polymeric	3, 5, 15	120	300	17	Yes
C18-PAQ	Octadecyl	Polymeric	5	120	300	11	Yes
Protein-R	Octadecyl	Polymeric	5	300	150	Proprietary	Yes
PYE	2-(1-Pyrenyl)ethyl	-	5	120	300	18	Yes
NPE	Nitrophenylether	-	5	120	300	9	Yes
PBB	Pentabromobenzyl	-	5	120	300	8	Yes
HIC	Diol	-	5	300	150	7	Proprietary
Sugar-D	Proprietary	-	5	Proprietary	Proprietary	Proprietary	Proprietary
Cholester	Cholesteryl	Monomeric	2.5 ¹ , 5	120	300	20	Yes
HILIC	Triazole	-	2.5 ¹ , 5	120	300	Proprietary	-
πNAP	Naphthylethyl	Monomeric	2.5 ¹ , 5	120	300	11	Yes

¹ Pore size 130Å, surface area 330m²/g

² Additional bonded phases available – see below and also page p.79

COSMOSIL C18 Phases

The availability of a range of C18 phases allows the chromatographer to select the most appropriate phase for a specific application.

1) COSMOSIL C18-MS-II is a monomerically bonded C18 phase. A new endcapping treatment with polar groups has extended the pH range of the material (2-10) and improved peak shape for basic compounds. This phase is recommended for the separation of low molecular weight organic compounds.

2) COSMOSIL C18-AR-II is a polymerically bonded C18 phase exhibiting strong acid resistance (down to pH 1.5). It is particularly effective for the separation of chelating compounds as well as both acidic and basic compounds, including biopolymers. Compared with the monomeric COSMOSIL C18-MS-II, the polymeric C18-AR-II shows superior molecular shape selectivity.

3) COSMOSIL C18-PAQ maintains stable retention time even in 100% aqueous eluents, due to partial coverage of the silica with C18 chains. A new mode of polymeric linkage gives the phase a strong acidic resistance and provides good separation for hydrophilic compounds.

4) COSMOSIL Protein-R is a polymerically bonded wide pore phase, designed specifically for the separation of large peptides and proteins. High recovery is observed for a variety of proteins.

Figures 1 and 2 show the application of COSMOSIL 5C18-AR-II and 5C18-MS-II phases for the analysis of isoflavones and antipyretics respectively.

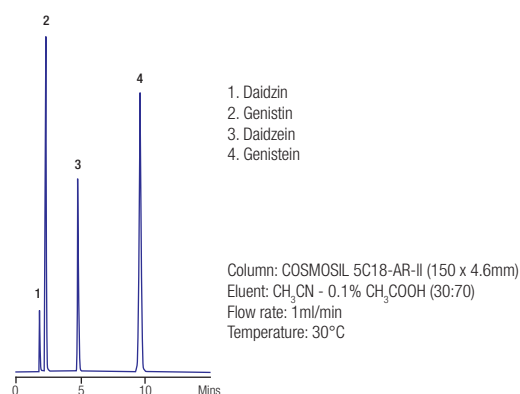

Figure 1. Separation of isoflavones on COSMOSIL 5C18-AR-II

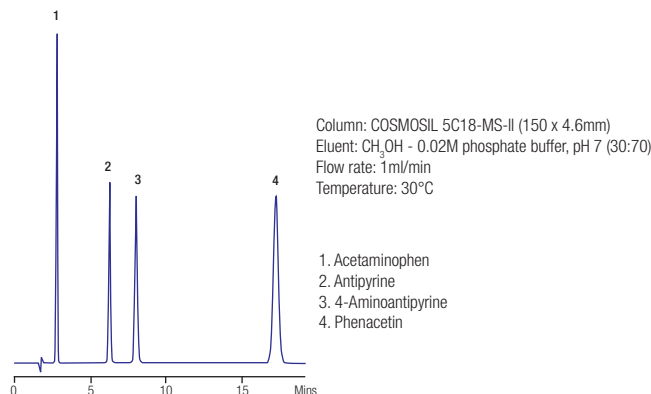

Figure 2. Separation of antipyretics on COSMOSIL 5C18-MS-II

Additional Bonded Phases

Alternative alkyl chain length columns, COSMOSIL C22-AR-II, 5C8-MS, 5C4-MS, and 5TMS-MS, and COSMOSIL 5NH2-MS, 5CN-MS and 5Diol columns are also available. Please contact Hichrom for further details.

Speciality Phases

Bonding and Main Interactions

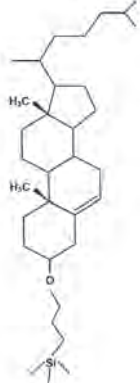
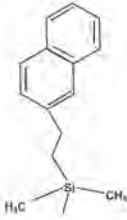
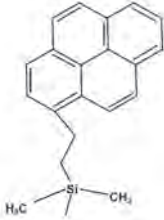
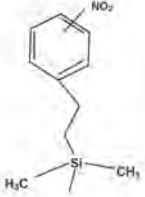
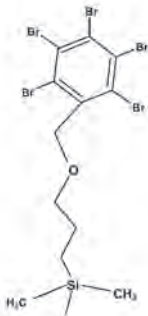
Cholester	π NAP	PYE	NPE	PBB-R
				
Cholesteryl group	Naphthylethyl group	Pyrenylethyl group	Nitrophenylethyl group	Pentabromobenzyl group
Hydrophobic Interaction Molecular Shape Selectivity	Hydrophobic Interaction π - π Interaction	Hydrophobic Interaction π - π Interaction Charge-transfer Interaction Dispersion Force	Hydrophobic Interaction π - π Interaction Dipole-dipole Interaction	Hydrophobic Interaction Dispersion Force

COSMOSIL® Cholester is a novel 3-[(cholesteryl)oxy]propylsilyl bonded silica phase. It shows the same hydrophobicity as C18 bonded phases, so can be used under similar reversed-phase conditions. However, a slightly different selectivity may be obtained. In particular, the rigid structure of the cholesterol imparts greater separation capabilities for isomeric, double-bonded and polyaromatic compounds. Figure 3 shows a comparison of stereoselectivity of Cholester and C18 phases for o-terphenyl and triphenylene.

COSMOSIL π NAP is a naphthylethyl bonded silica phase. The presence of two aromatic rings leads to stronger π - π interactions than with phenyl phases. COSMOSIL π NAP columns offer improved separation of positional isomers that are difficult to separate with alkyl bonded materials.

COSMOSIL PYE is a reversed-phase column with 2-(1-pyrenyl)ethyl groups bonded to the silica material. This column utilises π - π interactions originating from the planar pyrene ring structure to separate structural isomers (see Figure 4). Symmetrical isomers are retained more strongly. COSMOSIL PYE shows the strongest π - π interactions of all the speciality phases.

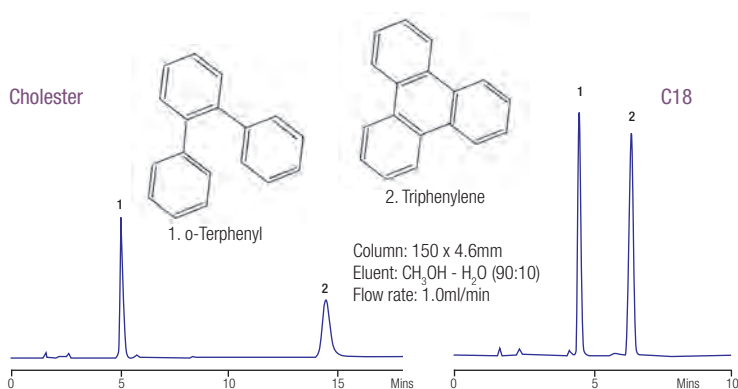

Figure 3. Comparison of stereoselectivity

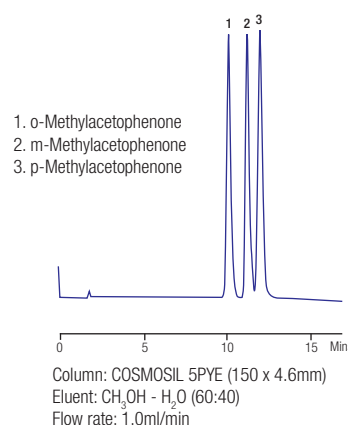

Figure 4. Separation of di-substituted benzenes

COSMOSIL NPE provides unique retention characteristics, utilising both dipole-dipole and π - π interactions. This is illustrated (Figure 5 on page 78) by the separation of a mixture of polychlorodibenzo-p-dioxins (pCDDs). Isomers with a strong dipole moment exhibit greater retention.

COSMOSIL PBB-R provides unique selectivity for structurally similar compounds utilising dispersion force interactions, and can separate structural isomers which differ by only a double bond. Figure 6 on page 78 shows the separation by dispersion force of Triton X-100 components on COSMOSIL PBB-R. Using a C18 column no separation was achieved, due to the poor hydrophobicity of the (-OCH₂CH₂-) group.

Speciality Phases (continued)

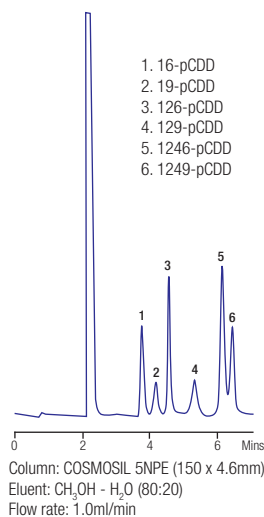

Figure 5. Polychlorodibenzo-p-dioxins (pCDDs)

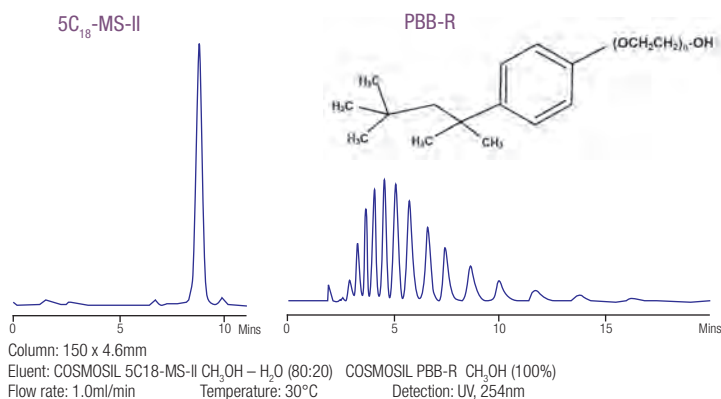

Figure 6. Analysis of Triton X-100 on COSMOSIL PBB-R

COSMOSIL® HILIC

- Novel triazole bonded phase
- Strong retention for acidic compounds
- Enhanced sensitivity in LC-MS
- Good retention of polar compounds

COSMOSIL® HILIC is a triazole bonded silica phase. It has a higher polarity than non-bonded silica commonly used for HILIC, resulting in stronger hydrophilic interactions. The positively charged triazole stationary phase also shows an anion-exchange mechanism, enabling acidic compounds to be strongly retained. The two separation modes – HILIC and ionic interaction – can be controlled by varying key eluent parameters such as pH, concentration of organic solvent and buffer ionic strength.

Figure 7 shows the advantage of using a triazole-bonded silica over non-bonded silica for the HILIC separation of trimethylene glycol and ethylene glycol.

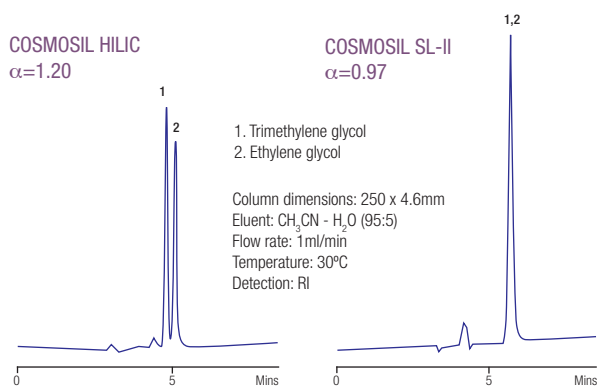

Figure 7. Hydrophilic interactions



COSMOSIL HILIC
Applications Guide
available on request

COSMOSIL Sugar-D

- Novel amino column for saccharides
- Improved column lifetime
- Useful for hydrophilic compounds

COSMOSIL Sugar-D is a novel phase designed for the analysis of saccharides. According to Nacal Tesque it shows improved column durability compared to standard aminopropyl bonded phases, due to a new 'defence shield' bonding technology. This protection also minimises undesirable adsorption of certain saccharides. Figure 8 shows the separation of polyols on COSMOSIL Sugar-D. In addition, COSMOSIL Sugar-D is useful for separating highly hydrophilic compounds which are not retained on conventional C18 phases.

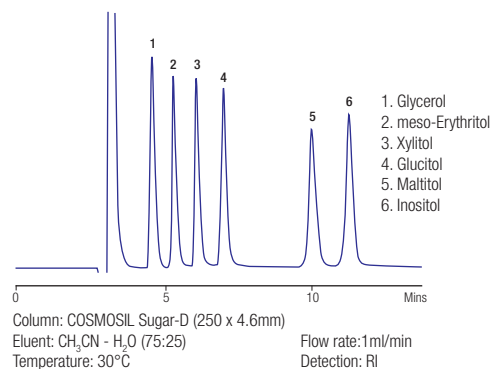

Figure 8. Analysis of polyols on COSMOSIL Sugar-D phase

Other Phases

COSMOSIL® Wide Pore Phases

The COSMOSIL® AR-300 series of packed columns are designed for the analysis of proteins and peptides and show good reproducibility and stability when used with TFA. Four phases are available: 5C18-AR-300, 5C8-AR-300, 5C4-AR-300 and 5Ph-AR-300.

COSMOSIL HIC

COSMOSIL 5HIC is a wide pore diol-bonded column for hydrophobic interaction chromatography. It is designed for the one-step desalting and separation of proteins, without denaturation. It has a higher loading capacity than ODS columns.

Special Columns for Fullerenes

The COSMOSIL range offers a variety of columns designed for the preparative scale separation of fullerenes and metallofullerenes. These include COSMOSIL Buckyprep and COSMOSIL PBB.

COSMOGEL IEX Series

The COSMOGEL IEX Series consists of anion-exchange, cation-exchange and amphoteric ion-exchange phase types (see table below). These are useful for the separation of biopolymers including proteins and nucleic acids.

Ion Exchange Mode	Anion-exchange Type		Cation-exchange Type		Amphoteric Ion-exchange Type	
	Type Q	Type Q-N	Type S	Type S-N	Type M	Type M-N
Packing Material	Hydrophilic Polymer / 5µm		Hydrophilic Polymer / 5µm		Hydrophilic Polymer / 5µm	
Gel / Average Particle Size	1000Å		1000Å		1000Å	
Average Pore Size	Non-porous		Non-porous		Non-porous	
Functional Group	-CH ₃ N ⁺ (CH ₃) ₃		-(CH ₂) ₃ SO ₃ ⁻		-CH ₃ N ⁺ (CH ₂) ₃ + -(CH ₂) ₃ SO ₃ ⁻	
Target Sample	Acidic proteins and DNA		Basic proteins		All proteins	

COSMOSIL SFC Columns

Two bonded phases have been developed to enhance the capability of SFC separations - COSMOSIL 3-Hydroxyphenyl and COSMOSIL Quinoline. COSMOSIL Quinoline shows improved separations of structural isomers of polar lipids, such as cholesterol, used as potential biomarkers. Please contact Hichrom for further information.

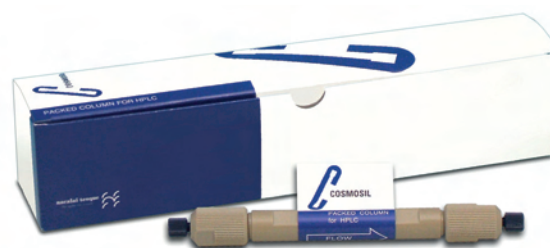

Ordering Information

5µm COSMOSIL Phase	Column Dimensions ¹ (mm)						Guard Column (10 x 4.6mm, 1/pk)
	150 x 2.0	250 x 2.0	50 x 4.6	100 x 4.6	150 x 4.6	250 x 4.6	
SL-II	-	-	37999-81	38000-01	38001-91	38002-81	37997-01
C18-AR-II	37992-51	05272-71	38142-51	38143-41	38144-31	38145-21	38141-61 ²
C18-MS-II	38025-91	05761-61	38017-01	38018-91	38019-81	38020-41	38014-31 ²
C18-PAQ	34449-71	05795-31	34451-21	05799-91	02486-71	02485-81	02484-91
Protein-R	06514-71	-	06525-31	-	06526-21	06527-11	06518-31
PYE	38042-61	34450-31	38043-51	-	37837-91	37989-11	37903-11
NPE	34328-51	34379-91	-	-	37902-21	37990-71	37904-01
PBB-R	05900-31	-	-	-	05697-21	05698-11	05704-11
HIC	-	-	04263-21	-	-	-	-
Sugar-D	05688-41	05689-31	07975-11	-	05395-71	05397-51	05394-81
Cholesterol	05971-11	05972-01	-	06591-61	05976-61	05977-51	05975-71
HILIC	07054-71	-	-	-	07056-51	07057-41	07055-61
πNAP	08078-41	08079-31	08083-61	08084-51	08085-41	08086-31	08082-71

¹ Other dimensions available, including preparative columns

² Guard cartridges (3/pk) also available – please enquire

Please contact Hichrom for further details and ordering information on COSMOSIL and COSMOGEL phases not listed above.

- Spherical porous silica
- Range of C18 phases for different selectivity
- Range of C30 phases for high aqueous eluents and polar selectivity

Develosil® columns are manufactured by Nomura Chemical Co. Ltd, Japan. Six different C18 phases are offered: ODS-UG, ODS-HG, ODS-MG, ODS-SR, XG-C18 and the speciality PAHS. Each phase offers slightly different selectivity, enabling the chromatographer to fine-tune difficult separations. A series of C30 bonded columns provide added retention for polar compounds using 100% aqueous eluents. Develosil wide pore (300Å) C4-HG, C8-HG and ODS-HG can also be supplied.

Develosil Phases³

Develosil Phase ¹	Functional Group	Endcapped	Particle Size (µm)	Pore Size (Å)	Surface Area (m ² /g)	Carbon Load (%)	Bonding Type
TMS-UG	C1	Yes	3, 5	140	300	4.5	Monomeric, monofunctional
C8-UG	C8	Yes	3, 5	140	300	11	Monomeric, monofunctional
ODS-UG	C18	Yes	3, 5	140	300	18	Monomeric, monofunctional
Phenyl-UG	Phenyl	Yes	3, 5	140	300	8	Monomeric, monofunctional
CN-UG	CN	Yes	5	140	300	7	Monomeric, monofunctional
RPAQUEOUS (C30-UG) ²	C30	Yes	3, 5	140	300	18	Monomeric, monofunctional
RPAQUEOUS-AR	C30	Yes	3, 5	140	300	18	Monomeric, trifunctional
ODS-MG	C18	Yes	3, 5	100	450	15	Monomeric, difunctional
ODS-HG	C18	Yes	3, 5	140	300	18	Monomeric, trifunctional
ODS-SR	C18	Yes	3, 5	80	-	18	Monomeric, difunctional
PAHS	C18	No	3, 5	120	350	23	Polymeric, trifunctional
XG-C18	C18	Yes	3, 5	140	300	19	Monomeric, monofunctional
XG-C30	C30	Yes	3, 5	140	300	19.5	Monomeric, monofunctional
XG-CN	CN	Yes	3, 5	140	300	7.5	Monomeric, monofunctional

¹ Develosil wide pore (300Å) phases C4-HG, C8-HG and ODS-HG also available

² The Combi-RP phase (see p. 81) is identical to the RPAQUEOUS (C30-UG) phase

³ Please enquire for phases not listed

Comparison of ODS (C18) Columns

Develosil ODS-UG is the most stable Develosil phase under alkaline conditions and can be used at pH 1 – 10.

Develosil ODS-HG is the most stable under acidic conditions (pH 1 – 9) and can be used with up to 0.5% TFA.

Develosil ODS-MG equilibrates quickly and shows higher retention of polar compounds.

Develosil ODS-SR (Super Retentive) is the most retentive of the C18 phases and is ideal for LC-MS, as the higher organic solvent content required leads to higher sensitivity. Figure 1 shows a comparison of retention times for oxine-copper and caffeine on ODS-SR-5 and ODS-UG-5.

Develosil PAHS is an ODS bonded non-endcapped phase with polymeric bonding and shows the greatest steric selectivity. Figure 2 shows the separation of the 16 priority pollutant polyaromatic hydrocarbons.

Develosil XG-C18 is the newest addition to the C18 range and is based on high purity silica. The recommended pH range is 1.5 – 8.

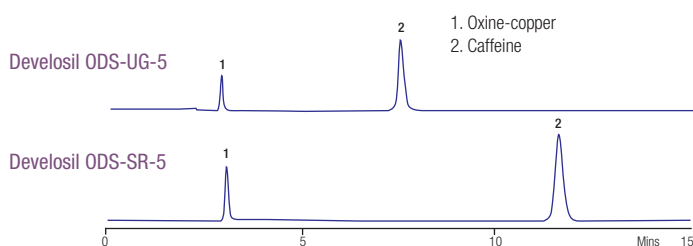

Figure 1. Comparison of retention times for ODS-SR-5 and ODS-UG-5

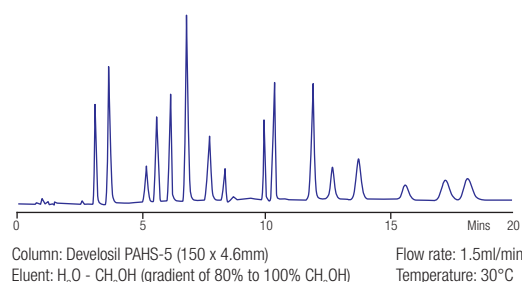

Figure 2. Analysis of 16 PAHs on Develosil PAHS-5

Bulk Preparative Develosil

Bulk preparative scale Develosil material can be supplied. Please contact Hichrom for further details of Develosil bulk material.

RPAQUEOUS*

Develosil® RPAQUEOUS is a C30 bonded phase that can be used under 100% aqueous conditions. In Figure 3 it is shown to be water stable for >150 hours, whereas the ODS-UG phase showed considerable loss of retention. It is believed that the C30 ligands remain in the solid state at a typical HPLC operating temperature of 30°C under these eluent conditions.

Combi-RP*

The Combi-RP phase is the same C30 material as the RPAQUEOUS phase. However, whereas RPAQUEOUS columns are intended for general purpose and LC-MS applications, Combi-RP is specially aimed at high throughput applications requiring 100% aqueous eluents (pH 2-8). Figure 4 shows the separation of five nucleic acid bases in under a minute.

RPAQUEOUS-AR

RPAQUEOUS-AR is an alternative C30 phase which shows increased stability under acidic conditions due to the nature of the trifunctional bonding. It is suitable for polar compounds such as sugars and nucleotides and also fat soluble compounds such as tocopherols and carotenoids.

* RPAQUEOUS, C30-UG and Combi-RP are the same material

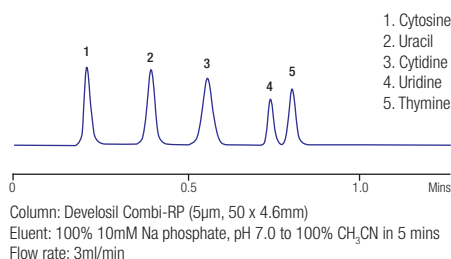

Figure 4. Separation of nucleic acid bases on Combi-RP

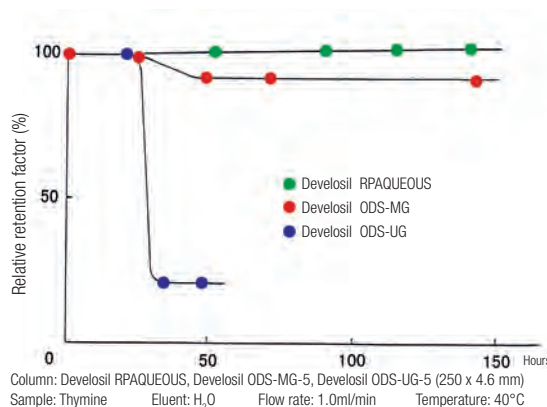

Figure 3. Effect of aqueous eluent on Develosil RPAQUEOUS, ODS-MG and ODS-UG phases

Ordering Information

Develosil 3µm Phase	Column Dimensions ¹ (mm)		
	50 x 4.6	100 x 4.6	150 x 4.6
ODS-UG-3	UG11346050W	UG11346100W	UG11346150W
ODS-MG-3	MG11346050W	MG11346100W	MG11346150W
ODS-HG-3	HG11346050W	HG11346100W	HG11346150W
ODS-SR-3	SR11346050W	SR11346100W	SR11346150W
PAHS-3	PAHS346050W	PAHS346100W	PAHS346150W
RPAQUEOUS-3	RPAQ346050W	RPAQ346100W	RPAQ346150W
RPAQUEOUS-AR-3	RPAR346050W	RPAR346100W	RPAR346150W

¹ Other dimensions available

Develosil 5µm Phase	Column Dimensions ¹ (mm)			Guard Cartridges ² (1/pk, 10 x 4.0mm)
	100 x 4.6	150 x 4.6	250 x 4.6	
ODS-UG-5	UG11546100W	UG11546150W	UG11546250W	UG11540010W
ODS-MG-5	MG11546100W	MG11546150W	MG11546250W	MG11540010W
ODS-HG-5	HG11546100W	HG11546150W	HG11546250W	HG11540010W
ODS-SR-5	SR11546100W	SR11546150W	SR11546250W	SR11540010W
PAHS-5	PAHS546100W	PAHS546150W	PAHS546250W	-
TMS-UG-5	UG14546100W	UG14546150W	UG14546250W	UG14540010W
C8-UG-5	UG12546100W	UG12546150W	UG12546250W	UG12540010W
Phenyl-UG-5	UG15546100W	UG15546150W	UG15546250W	UG15540010W
CN-UG-5	UG16546100W	UG16546150W	UG16546250W	UG16540010W
RPAQUEOUS-5	RPAQ546100W	RPAQ546150W	RPAQ546250W	UG17540010W
RPAQUEOUS-AR-5	RPAR546100W	RPAR546150W	RPAR546250W	RPAR540010W

¹ Other dimensions available

² Holder included

Develosil Phase	Particle Size (µm)	Column Dimensions ¹ (mm)				
		35 x 2.0	50 x 2.0	35 x 4.6	50 x 4.6	50 x 20.0
Combi-RP-3	3	COMB320035W	COMB320050W	COMB346035W	COMB346050W	-
Combi-RP-5	5	COMB520035W	COMB520050W	COMB546035W	COMB546050W	COMB5P2050W

¹ Other dimensions available

Please contact Hichrom for phases and column dimensions not listed.

Dikma® Technologies Inc. manufactures several ranges of HPLC and UHPLC columns, based on high purity metal-free silica.

Phase Specifications

Phase	Particle Size (µm)	Pore Size (Å)	Surface Area (m ² /g)	Carbon Load (%)	Endcapped	pH Range
Endeavorsil C18	1.8	120	300	20	Yes	1.5 - 10
Leapsil C18	2.7	100	440	27	Yes	1.5 - 10
Spursil C18	3, 5, 10	100	440	25	Yes	1.5 - 10
Spursil C18-EP	3, 5, 10	100	440	24	Yes	1.5 - 10
Inspire C18	3, 5, 10	100	440	27	Yes	1 - 11
Inspire C8	3, 5, 10	100	440	17	Yes	1 - 11
Bio-Bond C18	3, 5, 10	300	100	8	Yes	2 - 8
Bio-Bond C8	3, 5, 10	300	100	5	Yes	2 - 8
Bio-Bond C4	3, 5, 10	300	100	3	Yes	2 - 8

Endeavorsil™ C18

- 1.8µm particle size
- Combines speed, resolution and sensitivity

Endeavorsil C18 is a 1.8µm silica phase designed for ultra-fast separations with high efficiency, sensitivity and resolution. Columns show excellent separation characteristics over a wide pH range.

Leapsil™ C18

- 2.7µm particle size
- Compatible with all HPLC and UHPLC instruments
- Wide pH stability

Leapsil C18 is a 2.7µm particle size phase designed for ultra fast separations using HPLC or UHPLC instrumentation. Higher flow rates can be used, without compromising resolution or column back pressure.

Spursil™

- Unique selectivity and enhanced resolution
- Enhanced retention for polar compounds
- Stable retention in highly aqueous eluents

Spursil phases combine the benefits of high purity silica with unique polar modification technology. These columns maximise polar retention and selectivity, whilst virtually eliminating silanol activity. Figure 1 shows the separation of a group of cephalosporins on a Spursil C18 column.

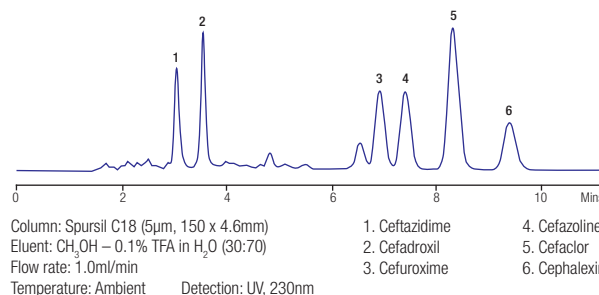

Figure 1. Separation of cephalosporins on Spursil C18

Inspire™

- High efficiency and selectivity
- Stable from pH 1 to 11
- Excellent batch-to-batch reproducibility

Inspire C18 and C8 columns are manufactured from high purity silica, using proprietary bonding techniques and tightly controlled manufacturing processes. Figure 2 shows the separation of antibacterials on an Inspire C18 column.

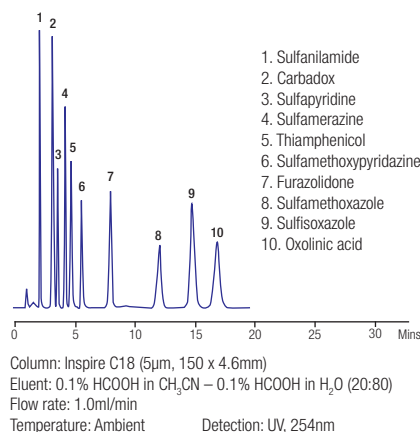

Figure 2. Separation of antibacterials on Inspire C18

Bio-Bond™

- C18, C8 and C4 wide-pore phases
- Proteins, peptides and biomolecule analyses

Bio-Bond phases are designed for the analysis and purification of proteins, peptides and other biomolecules. These are excellent columns for LC-MS due to low phase bleed. Dikma offers direct scale-up to preparative dimension columns and bulk materials.

Ordering Information

Endeavorsil™

1.8µm Phase	Column Dimensions (mm)		
	30 x 2.1	50 x 2.1	100 x 2.1
Endeavorsil C18	87001	87002	87003

Leapsil™

2.7µm Phase	Column Dimensions ¹ (mm)					
	50 x 2.1	100 x 2.1	150 x 2.1	50 x 4.6	100 x 4.6	150 x 4.6
Leapsil C18	86004	86005	86006	86001	86002	86003

¹ 3.0mm i.d. columns also available

Spursil™

3µm Phase	Column Dimensions ¹ (mm)				
	30 x 2.1	50 x 2.1	100 x 2.1	150 x 2.1	250 x 2.1
Spursil C18	82030	82004	82012	82013	82015
Spursil C18-EP	82130	82104	82112	82113	82115
	30 x 4.6	50 x 4.6	100 x 4.6	150 x 4.6	250 x 4.6
Spursil C18	82031	82016	82017	82018	82020
Spursil C18-EP	82131	82116	82117	82118	82120

5µm Phase	Column Dimensions ¹ (mm)				
	30 x 2.1	50 x 2.1	100 x 2.1	150 x 2.1	250 x 2.1
Spursil C18	82033	82003	82007	82002	82009
Spursil C18-EP	82133	82103	82107	82102	82109
	30 x 4.6	50 x 4.6	100 x 4.6	150 x 4.6	250 x 4.6
Spursil C18	82034	82010	82011	82001	82006
Spursil C18-EP	82134	82110	82111	82101	82106

¹ 3.0mm i.d. columns also available

Inspire™

3µm Phase	Column Dimensions ¹ (mm)					Guard Cartridges ³ , 2/pk
	30 x 2.1	50 x 2.1	100 x 2.1	150 x 2.1	250 x 2.1	
Inspire C18	81030	81004	81012	81013	81015	6501
Inspire C8	81130	81104	81112	81113	81115	6502
	30 x 4.6	50 x 4.6	100 x 4.6	150 x 4.6	250 x 4.6	10 x 4.0
Inspire C18	81031	81016	81017	81018	81020	6601
Inspire C8	81131	81116	81117	81118	81120	6602

5µm Phase	Column Dimensions ^{1,2} (mm)					Guard Cartridges ³ , 2/pk
	30 x 2.1	50 x 2.1	100 x 2.1	150 x 2.1	250 x 2.1	
Inspire C18	81033	81003	81007	81002	81009	6503
Inspire C8	81133	81103	81107	81102	81109	6504
	30 x 4.6	50 x 4.6	100 x 4.6	150 x 4.6	250 x 4.6	10 x 4.0
Inspire C18	81034	81010	81011	81001	81006	6603
Inspire C8	81134	81110	81111	81101	81106	6604

¹ 3.0mm i.d. columns also available² 5 and 10µm semi-preparative columns also available³ Use with EasyGuard holder 6220

Bio-Bond™

3µm Phase	Column Dimensions ¹ (mm)					Guard Cartridges ² , 2/pk	
	50 x 2.1	150 x 2.1	50 x 4.6	150 x 4.6	250 x 4.6	10 x 2.1	10 x 4.0
Bio-Bond C18	84004	84013	84016	84018	84020	6901	6951
Bio-Bond C8	84104	84113	84116	84118	84120	6902	6952
Bio-Bond C4	84404	84413	84416	84418	84420	6905	6955
5µm Phase	50 x 2.1	150 x 2.1	50 x 4.6	150 x 4.6	250 x 4.6	10 x 2.1	10 x 4.0
Bio-Bond C18	84003	84002	84010	84001	84006	6903	6953
Bio-Bond C8	84103	84102	84110	84101	84106	6904	6954
Bio-Bond C4	84403	84402	84410	84401	84406	6906	6956

¹ Semi-preparative columns also available² Use with EasyGuard holder 6220

Please contact Hichrom for further information on Dikma columns.

EPROGEN

- Reversed-phase and ion-exchange silica phases
- SynChropak bonding chemistry
- Well suited for preparative formats

Eprogen Inc. manufactures a range of phases for reversed-phase, ion-exchange and size exclusion chromatography. The products listed below are based on the well-established SynChropak® bonding chemistry. The range is well suited to scaling up to preparative formats.

Eprogen Phases

Phase	Functional Group	Particle Size (µm)	Pore Size (Å)	Applications
Reversed-phase				
RP8	C8 (monomeric)	5	300	Peptides, proteins
SCD	Short alkyl chain	5	100	Pharmaceuticals
Ion-exchange				
AX300	Polyethyleneimine	6	300	Peptides, proteins
Q300	Quaternary amine	6	300	Proteins
CM300	Carboxymethyl	6	300	Proteins, haemoglobin
S300	Sulphonic acid	6	300	Basic peptides, proteins

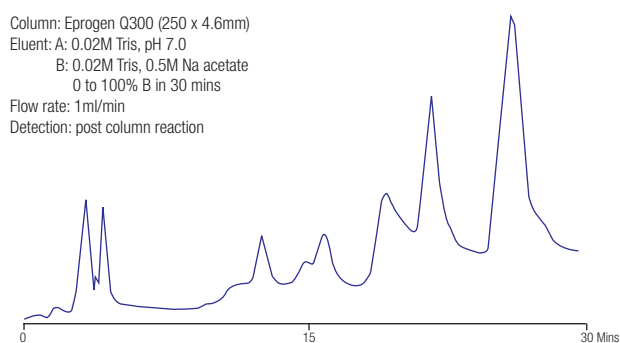

Figure 1. Analysis of lactate dehydrogenase isoenzymes

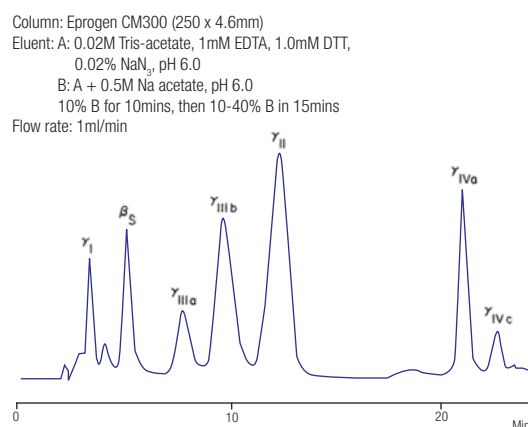

Figure 2. Analysis of calf lens crystallins

Ordering Information – Hichrom Manufactured Columns

Eprogen Phase	Column Dimensions ¹ (mm)		Guard Cartridges ^{2,3} (For 4.6mm i.d. Columns)
	150 x 4.6	250 x 4.6	
RP8	C8R103-150A	C8R103-250A	C8R103-10C5
SCD	SCD100-150A	SCD100-250A	SCD100-10C5
AX300	A103-150A	A103-250A	A103-10C5
Q300	Q103-150A	Q103-250A	Q103-10C5
CM300	CM103-150A	CM103-250A	CM103-10C5
S300	S103-150A	S103-250A	S103-10C5

¹ Other column dimensions available – please enquire

³ 5/pk – Starter kits also available – see p. 21

² Use with free-standing holder HI-161 and column coupler HI-081 – see p. 20

In addition to the Hichrom manufactured columns listed above, Eprogen packed columns can be provided, including:

- Non-porous silica (1.5µm) phases based on MICRA® NPS® technology
- Eprogen IEX columns – strong and weak anionic and cationic ion exchangers on polymer coated silica supports (AX300, Q300, CM300, S300 and S1000)
- Eprogen GPC and CATSEC columns – size exclusion technology for polymer and biomolecule separations (based on original SynChropak® bonding technology)

Please contact Hichrom for further details of Eprogen packed columns.

ES Industries, based in the north of the USA, have been manufacturing HPLC columns for over 30 years and more recently also manufacture columns specifically for SFC. An outline of some of their more popular product ranges is given below.

Epic®

The Epic range is based on high density bonded monomeric phases, produced through a proprietary bonding process. Epic columns are compatible with a wide range of organic modifiers and buffers and stable over a wide pH range. All phases have a pore size of 120Å and are available with particle sizes of 1.8, 3, 5 and 10µm and with microbore to preparative dimensions.

Available phases: C18, C18-MS, C18-SD, C8, C4-SD, Polar, PFP, HILIC, Phenyl-Hexyl, SCX

AquaSep™

AquaSep was developed for the separation of polar compounds using high aqueous eluents. The 100Å phase contains an ether linkage near the point of attachment to the silica base. This allows water to penetrate the surface and prevents 'pore dewetting'. AquaSep can retain highly water soluble compounds such as small organic acids (see Figure 1).

FluoroSep™-RP

FluoroSep-RP is a family of reversed-phase fluorinated ligands bonded to high efficiency silica. These phases are stable from pH 2 to 8 and may be heated to 80°C.

Three phases are available:

FluoroSep-RP Phenyl (FSP) – Pentafluorophenyl functional group, 60Å pore size

FluoroSep-RP Octyl (FO) – Perfluorooctyl functional group, 60Å pore size

FluoroSep-RP Propyl (FP) – Perfluoropropyl functional group, 300Å pore size

GammaBond™ Alumina

GammaBond Alumina is a family of exceptionally stable spherical alumina-based HPLC columns designed to provide high efficiency and unique selectivity for extreme pH applications (pH 1.3 to 12).

Two phases are available:

GammaBond Alumina – manufactured by bonding a polymer to 5µm porous spherical alumina particles, with a pore size of 130Å.

GammaBond RP-1 – a low load polybutadiene coated alumina, 80Å pore size with both reversed-phase and ion-exchange characteristics. This phase is classified as USP L29.

Chromegabond®

Chromegabond columns manufactured by ES Industries constitute a wide range of bonded phases, some being exclusive to ES Industries. Spherical silica phases in 3, 5 or 10µm particle sizes are available with pore diameters ranging from 60 to 1000Å.

Phases include: C18, C8, C4, Dimethyl, Cyclohexyl, Alkyl Phenyl, Diol, Amino, Diamine, Triamine, C22, Fluorinated C18, Monoalcohol (NPI), Nitro, Mixed amino/cyano, columns for petroleum product applications (RingSep, DNAP, Silver/SI) and others.

GreenSep™ Columns for SFC

ES Industries offer the GreenSep range of phases specifically designed for SFC separations. These 120Å pore size phases have proved to show superior separation, selectivity, peak shape and loading capacity compared to conventional normal-phase HPLC materials adapted for SFC (eg. amino, cyano, diol). All GreenSep phases are available as analytical, semi-preparative (10mm and 15mm i.d.) and preparative (20mm, 30mm and 50mm i.d.) columns.

Phases include:

Ethylpyridine – good for strongly basic compounds

Nitro – useful for geometrical isomers and compounds containing aromatic groups, polarisable electrons and conjugate systems

Basic – based on imidazole chemistry, good retention of amine-containing basic compounds

Pyridyl Amide – good for compounds with both amine and acidic functional groups

Additional phases include Amino Phenyl, DEAP (Diethylaminopropyl), PFP and Silica

Please contact us for ordering information on all ES Industries products.

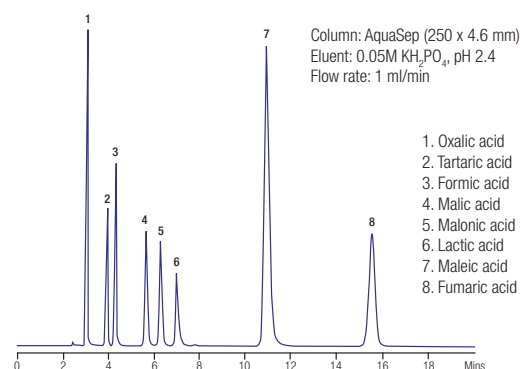

Figure 1. Separation of organic acids

- Spherical porous silica
- 80 and 100Å pore sizes
- Competitively priced
- Hichrom high efficiency

Exsil™, initially developed by Exmere and now manufactured by Grace Materials Technologies / Discovery Sciences, is firmly established as a useful alternative to the classical spherical HPLC silicas. Exsil 100, the standard material, is supplied in a range of particle sizes and bonded phases to cover a wide range of applications. Exsil 80 is a higher surface area, complementary range of materials. Please enquire for further details.

Exsil Phases

Exsil Phase	Functional Group	Endcapped	Particle Size (µm)	Pore Size (Å)	Surface Area (m ² /g)	Carbon Load (%)
Silica	-	-	5, 10	100	200	-
C1	Methyl	No	3, 5	100	200	3
C8	Octyl	Yes	3, 5	100	200	6
ODS	Octadecyl	Yes	3, 5, 10	100	200	11
ODS1	Octadecyl	No	3, 5	100	200	7
ODSB	Octadecyl	Yes	3, 5	100	200	12
CN	Cyano	No	3, 5	100	200	3.5
NH2	Amino	No	3, 5	100	200	2
SAX	Tetramethyl ammonium	No	5	100	200	3
SCX	Sulphonic acid	No	5	100	200	3

Ordering Information – Hichrom Manufactured Columns

Microbore (1.0 – 2.1mm i.d.) and Medium Bore (3.2mm i.d.) Columns

Please contact Hichrom for further details of 1.0, 2.1 and 3.2mm i.d. Exsil columns

Analytical (4.6mm i.d.) Columns

Exsil Phase	Column Dimensions ¹ (mm)				Guard Cartridges ^{2,3} (For 4.6mm i.d. Columns)
	50 x 4.6	100 x 4.6	150 x 4.6	250 x 4.6	
3µm					
C1	EXC1-3-50A	EXC1-3-100A	EXC1-3-150A	-	EXC1-3-10C5
C8	EXC8-3-50A	EXC8-3-100A	EXC8-3-150A	-	EXC8-3-10C5
ODS	EXODS-3-50A	EXODS-3-100A	EXODS-3-150A	-	EXODS-3-10C5
ODS1	EXODS1-3-50A	EXODS1-3-100A	EXODS1-3-150A	-	EXODS1-3-10C5
CN	EXCN-3-50A	EXCN-3-100A	EXCN-3-150A	EXCN-3-250A	EXCN-3-10C5
NH2	EXNH-3-50A	EXNH-3-100A	EXNH-3-150A	EXNH-3-250A	EXNH-3-10C5
ODSB	EXODSB-3-50A	EXODSB-3-100A	EXODSB-3-150A	-	EXODSB-3-10C5
5µm					
Silica	EX-5-50A	EX-5-100A	EX-5-150A	EX-5-250A	EX-5-10C5
C1	EXC1-5-50A	EXC1-5-100A	EXC1-5-150A	EXC1-5-250A	EXC1-5-10C5
C8	EXC8-5-50A	EXC8-5-100A	EXC8-5-150A	EXC8-5-250A	EXC8-5-10C5
ODS	EXODS-5-50A	EXODS-5-100A	EXODS-5-150A	EXODS-5-250A	EXODS-5-10C5
ODS1	EXODS1-5-50A	EXODS1-5-100A	EXODS1-5-150A	EXODS1-5-250A	EXODS1-5-10C5
CN	EXCN-5-50A	EXCN-5-100A	EXCN-5-150A	EXCN-5-250A	EXCN-5-10C5
NH2	EXNH-5-50A	EXNH-5-100A	EXNH-5-150A	EXNH-5-250A	EXNH-5-10C5
ODSB	EXODSB-5-50A	EXODSB-5-100A	EXODSB-5-150A	EXODSB-5-250A	EXODSB-5-10C5
SAX	EXSAX-5-50A	EXSAX-5-100A	EXSAX-5-150A	EXSAX-5-250A	EXSAX-5-10C5
SCX	EXSCX-5-50A	EXSCX-5-100A	EXSCX-5-150A	EXSCX-5-250A	EXSCX-5-10C5
10µm					
Silica	-	EX-10-100A	EX-10-150A	EX-10-250A	EX-10-10C5
ODS	-	EXODS-10-100A	EXODS-10-150A	EXODS-10-250A	EXODS-10-10C5

¹ Other column dimensions available – please enquire

² 5/µk – Use with free-standing holder HI-161 and column coupler HI-081 – see p. 20

³ Starter kits also available – see p. 21

GL Sciences of Tokyo, Japan manufacture the well established Inertsil® series of HPLC columns. InertSustain® is their latest series of high purity silica bonded phases, with the C18 phase showing increased durability over a wide pH range. The Inertsil 2, 3 and 4 Series are successive generations of silica bonded phases. GL Sciences also manufacture Titansphere®, which consists of porous spherical particles of titanium dioxide, that displays amphoteric ion-exchange properties. These products are specifically designed for biological applications involving phosphopeptide extraction.

InertSustain®

InertSustain phases are based on a new type of silica, the surface of which is uniquely modified, enabling precise control of the silica properties. The InertSustain C18 phase combines the advantages of all previous Inertsil columns (eg. inertness, low back pressure, high efficiency) with durability over a wide pH range. Further bonded phases in the InertSustain range include C8, Phenyl and NH₂.

Inertsil® 4 Series

The Inertsil 4 series is based on enhanced deactivation techniques which produce highly inert silica, enabling successful analysis of trace levels of the most demanding basic and acidic compounds. Strictly classified particle size, with narrow distribution width and an ideal carbon loading, enables high efficiency columns to be guaranteed. Available phases – ODS-4, ODS-4V (validated) and C8-4.

Inertsil 3 Series

Compared with Inertsil 2 Series, Inertsil 3 Series phases are based on a purer, higher surface area silica which is specially manufactured to provide maximum phase coverage. The result is a series of columns which provide excellent peak shapes using simple eluents while operating at low pressure.

Inertsil 3 Series Phases

Phase	Endcapped	Particle Size (µm)	Pore Size (Å)	Surface Area (m ² /g)	Carbon Load (%)	Recommended pH Range*
SIL	-	3, 5	100	450	-	2 - 7.5
ODS-3	Yes	2, 3, 4, 5, 10	100	450	15	2 - 7.5
ODS-3V	Yes	3, 5	100	450	15	2 - 7.5
ODS-P	No	3, 5	100	450	29	2 - 7.5
ODS-EP	No	5	100	450	9	2 - 7.5
Peptide C18	Yes	5	100	450	15	2 - 7.5
ODS-Sprint	Yes	3, 5	100	450	8.5	2 - 7.5
Sulfa C18	Yes	3, 5	100	450	15	2 - 7.5
C8-3	Yes	2, 3, 5	100	450	9	2 - 7.5
Ph-3	No	2, 3, 5	100	450	9.5	2 - 7.5
CN-3	No	3, 5	100	450	14	2 - 7.5
NH ₂	No	3, 5	100	450	8	2 - 7.5
Diol	No	3, 5	100	450	22	2 - 7.5
HILIC	No	3, 5	100	450	20	2 - 7.5
Amide	No	3, 5	100	450	18	2 - 7.5
AX	No	5	100	450	17	2 - 7.5
CX	No	5	100	450	14	2 - 7.5

*Inertsil phases are known to provide excellent results at pH levels of 9 – 10. However, optimum column life may be achieved at a pH between 2 and 7.5.

Inertsil ODS-3V is a highly efficient validated HPLC column. Each lot of packing undergoes a series of critical QC analytical tests, consistent with the demands of GLP/GMP compliance.

Inertsil ODS-P is a polymerically bonded C18 phase, particularly suited to the separation of polycyclic aromatic hydrocarbons and shows additional retentivity for planar compounds.

Inertsil ODS-EP is a C18 phase with a polar embedded group, which creates a phase which is stable in 100% aqueous eluents. It provides highly reproducible separations for acids and bases in organic eluents as well as acidified eluents typically used in LC-MS.

Inertsil ODS-Sprint is super base deactivated and optimally bonded to retain polar compounds without excessive retention of non-polar compounds. It operates at low back pressures, even at high flow rates, and shows excellent robustness and reproducibility.

Inertsil Sulfa C18 is designed specifically for the analysis of sulpha drugs. It is also effective in the screening of synthetic antibacterial agents and residues in products of animal origin.

Inertsil Diol is a dihydroxypropyl bonded silica which can be used in both reversed-phase and normal-phase modes.

Inertsil® 3 Series (continued)

Inertsil® HILIC is a propyl alcohol bonded silica phase, suitable for the analysis of polar compounds in the HILIC mode. The high organic solvent composition of the eluent leads to high sensitivity LC-MS analyses, due to a decrease in ion suppression. Figure 1 shows a fast and sensitive LC-MS/MS method for the analysis of melamine and cyanuric acid contaminants.

Inertsil Amide is a carbamoyl bonded silica phase designed for the separation of highly polar compounds by HILIC.

Inertsil AX and CX are silica based anion- and cation-exchange phases respectively. They show good reproducibility, exceptional stability and long column lifetime.

Column: Inertsil HILIC (150 x 3.0mm)	Flow rate: 0.5ml/min
Eluent: A: 10mM ammonium acetate in CH ₃ CN	Temperature: 40°C
B: 10mM ammonium acetate in H ₂ O	Detection: MS/MS (ESI)
Gradient: T(mins)	%A %B
0	97 3
5.0	20 80
5.5	3 97

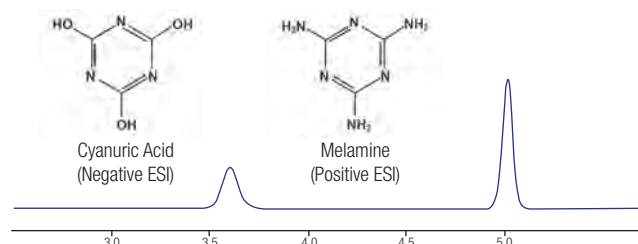

Figure 1. Analysis of melamine and cyanuric acid on Inertsil HILIC

Ordering Information – Hichrom Manufactured Columns Microbore (2.1mm i.d.) Columns

Inertsil Phase	Column Dimensions (mm)				
	3µm	50 x 2.1	100 x 2.1	150 x 2.1	250 x 2.1
ODS-3		INODS3-3-50DM	INODS3-3-100DM	INODS3-3-150DM	-
5µm					
ODS-3		INODS3-50DM	INODS3-100DM	INODS3-150DM	INODS3-250DM
C8-3		INC83-50DM	INC83-100DM	INC83-150DM	INC83-250DM
Ph-3		INP3-50DM	INP3-100DM	INP3-150DM	INP3-250DM
CN-3		INCN3-50DM	INCN3-100DM	INCN3-150DM	INCN3-250DM

Medium Bore (3.0mm i.d.) Columns

Inertsil Phase	Column Dimensions (mm)				
	3µm	50 x 3.0	100 x 3.0	150 x 3.0	250 x 3.0
ODS-3		INODS3-3-50DS	INODS3-3-100DS	INODS3-3-150DS	INODS3-3-250DS
5µm					
ODS-3		INODS3-50DS	INODS3-100DS	INODS3-150DS	INODS3-250DS
C8-3		INC83-50DS	INC83-100DS	INC83-150DS	INC83-250DS
Ph-3		INP3-50DS	INP3-100DS	INP3-150DS	INP3-250DS
CN-3		INCN3-50DS	INCN3-100DS	INCN3-150DS	INCN3-250DS

Analytical (4.6mm i.d.) Columns

Inertsil Phase	Column Dimensions (mm)				
	3µm	50 x 4.6	100 x 4.6	150 x 4.6	250 x 4.6
ODS-3		INODS3-3-50D	INODS3-3-100D	INODS3-3-150D	INODS3-3-250D
C8-3		INC83-3-50D	INC83-3-100D	INC83-3-150D	-
Ph-3		INP3-3-50D	INP3-3-100D	INP3-3-150D	-
5µm					
ODS-3		INODS3-50D	INODS3-100D	INODS3-150D	INODS3-250D
C8-3		INC83-50D	INC83-100D	INC83-150D	INC83-250D
Ph-3		INP3-50D	INP3-100D	INP3-150D	INP3-250D
CN-3		INCN3-50D	INCN3-100D	INCN3-150D	INCN3-250D

Please enquire for ordering information for other 3 Series phases as well as 4 Series and InertSustain products.

Inertsil 2 Series and Inertsil ODS

Inertsil 2 Series and Inertsil ODS Phases

Inertsil Phase	Functional Group	Endcapped	Particle Size (µm)	Pore Size (Å)	Surface Area (m ² /g)	Carbon Load (%)
ODS-2	Octadecyl	Yes	5	150	320	18.5
C8	Octyl	Yes	5	150	320	10.5
C4	Butyl	Yes	5	150	320	7.5
Phenyl	Phenyl	Yes	5	150	320	10
ODS*	Octadecyl	Yes	5	100	350	14

* From original Inertsil series

The well established Inertsil 2 Series phases are based on high purity silica which is robust and shows high reproducibility from batch-to-batch and column-to-column.

Inertsil® 2 Series (continued)

Ordering Information – Hichrom Manufactured Columns

Microbore (1.0mm i.d.) Columns

Inertsil Phase 5µm	Column Dimensions ¹ (mm)				Guard Cartridges ² (For 1.0mm i.d. Columns)
	50 x 1.0	100 x 1.0	150 x 1.0	250 x 1.0	
ODS-2	INODS2-50M	INODS2-100M	INODS2-150M	INODS2-250M	INODS2-10CE5 (5/pk) ³
C4	INC4-50M	INC4-100M	INC4-150M	INC4-250M	INC4-10CE5 (5/pk) ³
Phenyl	INP-50M	INP-100M	INP-150M	INP-250M	INP-10CE5 (5/pk) ³

Microbore (2.1mm i.d.) Columns

Inertsil Phase 5µm	Column Dimensions ¹ (mm)				Guard Cartridges ² (For 2.1mm i.d. Columns)
	50 x 2.1	100 x 2.1	150 x 2.1	250 x 2.1	
ODS-2	INODS2-50AM	INODS2-100AM	INODS2-150AM	INODS2-250AM	INODS2-10CM5 (5/pk) ³
C4	INC4-50AM	INC4-100AM	INC4-150AM	INC4-250AM	INC4-10CM5 (5/pk) ³
Phenyl	INP-50AM	INP-100AM	INP-150AM	INP-250AM	INP-10CM5 (5/pk) ³

Medium Bore (3.2mm i.d.) Columns

Inertsil Phase 5µm	Column Dimensions ¹ (mm)				Guard Cartridges ² (For 3.2mm i.d. Columns)
	50 x 3.2	100 x 3.2	150 x 3.2	250 x 3.2	
ODS-2	INODS2-50AS	INODS2-100AS	INODS2-150AS	INODS2-250AS	INODS2-10C5 (5/pk) ³
C4	INC4-50AS	INC4-100AS	INC4-150AS	INC4-250AS	INC4-10C5 (5/pk) ³
Phenyl	INP-50AS	INP-100AS	INP-150AS	INP-250AS	INP-10C5 (5/pk) ³

Analytical (4.0mm i.d.) Columns

Inertsil Phase 5µm	Column Dimensions ¹ (mm)				Guard Cartridges ² (For 4.0mm i.d. Columns)
	50 x 4.0	100 x 4.0	150 x 4.0	250 x 4.0	
ODS-2	INODS2-50AF	INODS2-100AF	INODS2-150AF	INODS2-250AF	INODS2-10C5 (5/pk) ³
C4	INC4-50AF	INC4-100AF	INC4-150AF	INC4-250AF	INC4-10C5 (5/pk) ³
Phenyl	INP-50AF	INP-100AF	INP-150AF	INP-250AF	INP-10C5 (5/pk) ³

Analytical (4.6mm i.d.) Columns

Inertsil Phase 5µm	Column Dimensions ¹ (mm)				Guard Cartridges ² (For 4.6mm i.d. Columns)
	50 x 4.6	100 x 4.6	150 x 4.6	250 x 4.6	
ODS-2	INODS2-50A	INODS2-100A	INODS2-150A	INODS2-250A	INODS2-10C5 (5/pk) ³
C4	INC4-50A	INC4-100A	INC4-150A	INC4-250A	INC4-10C5 (5/pk) ³
Phenyl	INP-50A	INP-100A	INP-150A	INP-250A	INP-10C5 (5/pk) ³

¹ Other column dimensions available – please enquire² Use with free-standing holder HI-161 and column coupler HI-081 – see p.20³ Starter kits also available – see p. 21

Semi-Preparative and Preparative (7.75 – 21.2mm i.d.) Columns

Please contact Hichrom for further details of 7.75 – 21.2mm i.d. Inertsil columns.

Titansphere®

Titansphere® consists of porous spherical particles of titanium dioxide, with a smooth and alkaline surface that displays amphoteric ion-exchange properties. Titansphere products are specifically designed for biological applications involving the selective isolation of low level phosphopeptides. Capillary columns, extraction cartridges, bulk material and PhosTiO extraction kits are all available. It is particularly useful in 2D chromatographic separations, where it is used as a precolumn or trap column prior to on-line column switching to a reversed-phase or ion-exchange analytical column.

Titansphere Phase

Nature of Phase	Spherical TiO ₂
Particle Size (µm)	5, 10
Pore Size (Å)	100
Surface Area (m ² /g)	100
pH Range	2 - 12



Please contact us for ordering information on Titansphere products.

Grace Materials Technologies / Discovery Sciences manufacture a number of silica based products for analytical, preparative and process scale chromatography. These products are suitable for a wide range of applications, including drug discovery and purification for the pharmaceutical and biotechnology industries, environmental analysis, forensics, petrochemical analysis, food, cosmetics and vitamins.

Vydac® Columns for Proteins and Peptides

Vydac columns were developed for bioseparations and became the benchmark for the reversed-phase separation of proteins and peptides. Vydac 300Å wide pore phases are available in a wide range of dimensions from nano and capillary, to micro and analytical, to preparative and process scale.

The Vydac TP range of phases was the first generation of wide pore media phases developed in the Vydac range. The large pores of the 300Å TP silica give polypeptide molecules complete access to the interior of the silica pores.

Vydac MS phases were developed from the original Vydac TP phases, by incorporating a surface treatment and proprietary bonding process. The MS product line is recommended for the LC-MS analysis of small peptides to large intact, undenatured proteins. Only low levels of ion-pairing reagents, such as trifluoroacetic acid (TFA) may be required.

Vydac TP and MS phases include:

- **208MS and 208TP** – C8 bonding, ideal for biomolecules of 5 -10,000 Da
- **214MS and 214TP** – C4 bonding, suitable for hydrophobic polypeptides larger than 4-5,000 Da
- **218MS, 218TP, 238MS and 238TP** – C18 bonding, suitable for small polypeptides < 4-5,000 Da
- **219MS and 219TP** – Diphenyl bonding, suitable for polypeptides with aromatic side chains
- **238EV (Everest)** – C18 bonding, monomeric, suitable for hydrophilic and hydrophobic peptides from complex protein digests

Subtle differences in selectivity may be observed between analyses using 218MS or 218TP polymeric bonded and 238MS or 238TP monomeric bonded C18 phases. Figure 1 shows a comparison between the selectivity of Vydac 218TP and 238TP for a mixture of peptides.

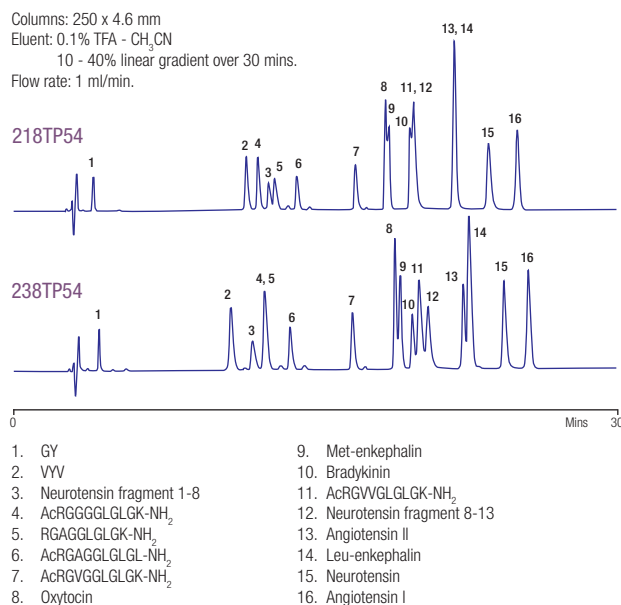

Figure 1. Separation of synthetic peptides on Vydac 218TP and 238TP phases

In addition to Vydac TP and MS capillary and analytical columns, Vydac TP preparative and process scale columns and bulk material are also available.

Vydac 201TP and 202TP

Vydac 201TP and 202TP columns were developed specifically for the separation and quantification of polyaromatic hydrocarbons (PAHs). Vydac 201TP columns also have application in the analysis of carotenoids, retinoids and vitamins.

VisionHT™

The VisionHT™ media platform has the mechanical strength required for ultra-high pressure use and the flexibility to expand seamlessly to larger particle sizes and multiple phase chemistries. The identical base silica is used for bonding 1.5, 3, 5 and 10µm particles. Method transfer between UHPLC, traditional and preparative HPLC systems is simple and quick. For 1.5µm phases, the exceptionally rigid silica structure withstands routine use at pressures of 16,000psi. Six VisionHT high purity phases are available, each with unique separation benefits. These include C18 High Load, C18 Basic, C18 Classic, C18 Polar, HILIC and Silica.

Genesis®

Genesis® phases are based on high purity metal-free spherical silica. They are suitable for the analysis of a wide range of analytes. Columns are supplied in conventional column hardware. Available phases include: Silica, C18, C8, C8e/c, AQ, Phenyl, CN and NH₂.

GraceSmart™

GraceSmart™ C18 is based on high purity silica which is monomerically bonded with uniform coverage. This phase is ideal for general use.

Please contact us for ordering information on Grace products.



HALO® UHPLC and HPLC columns were developed by Advanced Materials Technology using innovative Fused-Core® particle technology, whereby a porous silica layer is 'fused' onto solid spherical silica particles, producing 'superficially porous' or 'core-shell' particles. HALO 2.7µm particle phases for UHPLC applications were the first to be developed using this technology. The success of HALO UHPLC columns led to the development of HALO-5 HPLC columns packed with 4.6µm Fused-Core particles. These are well suited for use with legacy HPLC instruments.

HALO UHPLC Phases

The HALO 2.7µm UHPLC phases comprise a 1.7µm solid core and a 0.5µm porous outer shell (see Figure 1). HALO columns provide the efficiency and separation speed of sub 2µm particles but at approximately half the back pressure.

HALO-5 HPLC Phases

HALO-5 phases are based on the same Fused-Core technology as the original 2.7µm phases. They consist of solid core particles having a 0.6µm porous silica layer fused to the surface. HALO-5 columns show extremely high plate numbers compared with conventional porous 5µm phases and the equivalent or higher plate numbers compared with conventional 3µm phases, but with half the pressure.

HALO Protein and HALO Peptide Phases

HALO Protein and Peptide UHPLC columns are specifically designed for fast, high resolution separations of proteins and peptides. HALO Protein C4 is based on a 3.4µm particle with a thin (0.2µm) porous silica shell having pores of 400Å. It is optimum for the separation of larger proteins up to 500kDa. HALO Peptide columns (160Å) are recommended for peptides in the range of 3 to 20kDa.

HALO and HALO-5 Phases

HALO and HALO-5 Phase	Particle Size (µm)	Pore Size (Å)	Surface Area (m ² /g)	Carbon Load (%)	Endcapped	pH Range
C18	2.7 ¹ , 4.6 ²	90	135, 90	7.7, 5.5	Yes	2 - 9
C8	2.7 ¹ , 4.6 ²	90	135, 90	5.4, 3.7	Yes	2 - 9
HILIC (Silica)	2.7 ¹ , 4.6 ²	90	135, 90	-	No	1 - 8
RP-Amide	2.7 ¹	90	135	8.2	Yes	2 - 9
Phenyl-Hexyl	2.7 ¹ , 4.6 ²	90	135, 90	7.1, 5.2	Yes	2 - 9
PFP	2.7 ¹ , 4.6 ²	90	135, 90	5.5, 3.9	Yes	2 - 8
Penta-HILIC	2.7 ¹ , 4.6 ²	90	135, 90	3.2, 2.2	No	2 - 9
ES-CN	2.7 ¹ , 4.6 ²	90	135, 90	3.5, 2.5	Yes	2 - 9
Peptide ES-C18	2.7 ¹ , 4.6 ²	160	80, 60	4.6, 4.0	No	1 - 8
Peptide ES-CN	2.7 ¹ , 4.6 ²	160	80, 60	2.0, 1.5	Yes	1 - 8
Protein (C4)	3.4 ³	400	15	0.4	Yes	2 - 9

¹ 1.7µm solid core particle with 0.5µm porous silica layer fused to surface

² 3.4µm solid core particle with 0.6µm porous silica layer fused to surface

³ 3.0µm solid core particle with 0.2µm porous silica layer fused to surface

Figure 1. Fused-Core particle technology

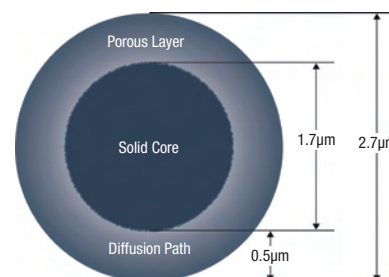

Advantages of HALO UHPLC and HPLC Columns

More Separating Power

HPLC and UHPLC columns packed with HALO particles deliver significantly more separating power compared to columns packed with traditional totally porous particles of the same size.

Hyper-fast Separations

The high efficiency of HALO Fused-Core particles permits the use of shorter columns to reduce analysis time without sacrificing resolution. In addition, HALO columns are designed to excel when operated at high eluent velocity. Therefore, short HALO columns operating at high eluent velocity can be used to achieve hyper-fast, high resolution separations.

Higher Efficiency at Lower Back Pressure

Columns packed with HALO particles deliver approximately 50% higher efficiency than typically expected based on particle size, but the back pressure is as expected for particle size. This means that HALO columns can generate the same separating power as sub 2µm totally porous particles, but at reduced back pressures. This lower pressure also enables many HALO UHPLC columns to be used on HPLC instruments, simplifying the transfer of methods from UHPLC to HPLC instruments.

Super-rugged Separations

The narrow particle size distribution of HALO particles enables rugged and reliable columns to be packed. It also enables the use of larger porosity inlet frits than required with other HPLC and UHPLC columns, thereby making them less prone to plugging from particulates.

Please contact us for ordering information on HALO Fused-Core products.

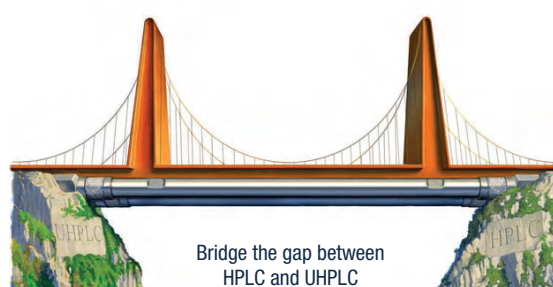

- Capillary to preparative scale dimensions
- ISO 9001:2008 (Quality) and ISO 14001:2004 (Environmental) standards
- Every column exceeds stringent quality test criteria
- Exceptional reproducibility and efficiency
- See also Partisil/Partisphere and Ultrasphere sections



Hichrom has been firmly established in the field of chromatography for over 30 years, specialising in the development, manufacture and supply of high quality HPLC products, both in the UK and throughout the entire world. During this time Hichrom has built up a strong reputation amongst chromatographers for technical expertise, speed of delivery and competitive pricing. Hichrom is accredited to both ISO 9001:2008 (Quality) and ISO 14001:2004 (Environmental) standards. Every Hichrom manufactured column exceeds stringent quality criteria and all columns are supplied with documentation enabling a complete audit trail from the time of manufacture to the point of use. In addition to the following range of Hichrom branded columns (pages 92-100) Hichrom offer a wide range of HPLC columns packed with any commercially available silica, an OEM manufacturing and custom bonding service and also manufacture the Partisil and Partisphere (see pages 121-125) and the Ultrasphere (see pages 156-157) brands.

Hichrom C8 and C18

- Ultra pure, base deactivated porous silica
- Suitable for acidic, basic and neutral molecules
- 3.5 and 5µm particle sizes
- Excellent reproducibility

Hichrom's C8 and C18 columns offer high performance in order to tackle the most challenging reversed-phase applications. The use of ultra pure silica, advanced bonding technology, superior column specification and comprehensive batch validation all contribute to the columns' excellent reproducibility.

Hichrom Phases

Phase	Functional Group	Endcapped	Particle Size (µm)	Pore Size (Å)	Surface Area (m ² /g)	Carbon Load (%)
C18	Octadecyl	Yes	3.5, 5	150	250	15
C8	Octyl	Yes	3.5, 5	150	250	8

Excellent Batch Reproducibility

Combining ultra pure silica with advanced bonding technology results in a densely bonded silica that is both highly robust and highly reproducible. Unpredictable interactions between residual silanol sites on the silica surface and the analyte are effectively eliminated. Comprehensive batch validation ensures absolute batch to batch reproducibility is maintained with acidic, basic and neutral molecules. Figures 1 and 2 show two of the tests used during the validation of Hichrom C8 and C18 phases.

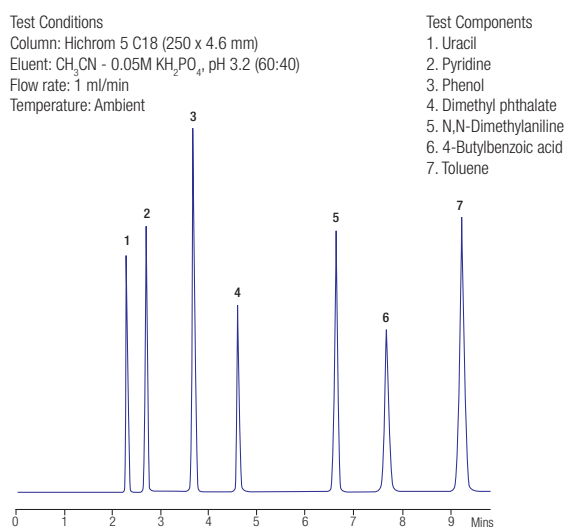

Figure 1. Validation test - Selectivity with acidic, basic and neutral molecules

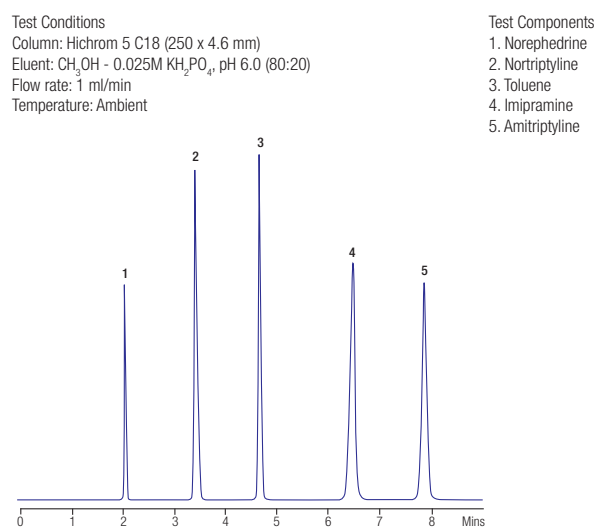

Figure 2. Validation test - Tricyclic antidepressants

Hichrom C8 and C18 (continued)

Excellent Batch Reproducibility (continued)

Figure 3 demonstrates the excellent selectivity match obtained with four Hichrom 5 C18 columns when subjected to the tricyclic antidepressants validation test. Each of these four columns is packed from a different batch of silica.

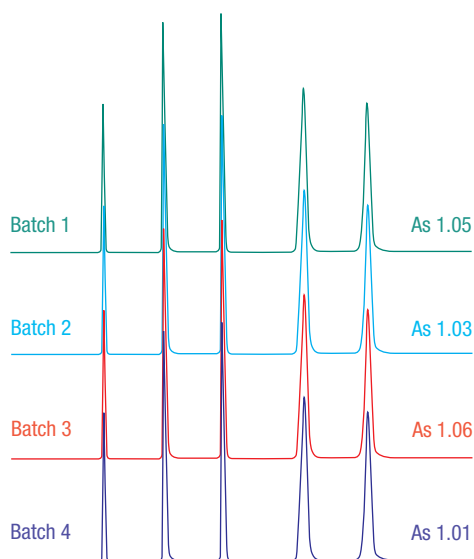

Figure 3. Batch reproducibility – Tricyclic antidepressants

Excellent Column Efficiency

- 3.5µm columns > 150,000 plates/metre
- 5µm columns > 90,000 plates/metre

Careful control of all stages during the manufacturing process results in a high purity silica with a tight particle size distribution. This results in excellent column efficiencies with both 3.5 and 5µm materials.



Every Hichrom C8 and C18 column is individually manufactured and meticulously tested in the Hichrom laboratory. Efficiency measurements and two peak asymmetry calculations are recorded for each component of the quality control test mixture. Samples of the quality control test mixture are available on request. Only columns exceeding the most stringent efficiency and peak shape specifications are approved for sale.

All Hichrom C8 and C18 columns are supplied with a Test Chromatogram and Batch Validation Certificate. Information regarding column care and use is displayed on the reverse of the Test Chromatogram.



Figure 4 shows the analysis of toluene using twenty Hichrom 5 C18 columns under standard quality control conditions. Excellent efficiency, peak asymmetry and column-to-column reproducibility are demonstrated.

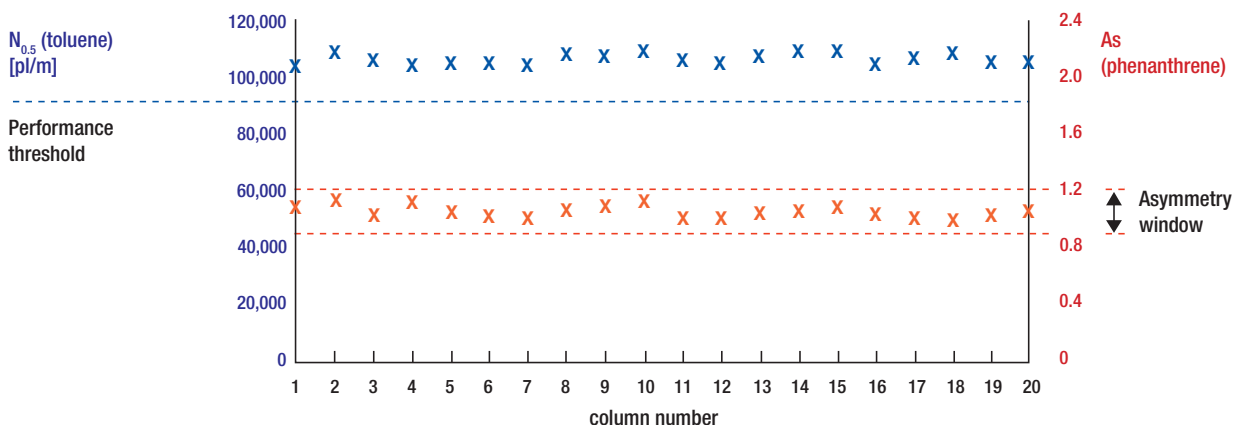

Figure 4. Excellent Hichrom 5 C18 column-to-column reproducibility

Hichrom C8 and C18 (continued)

Extended Column Lifetime

Hichrom C8 and C18 columns exhibit extended lifetimes – the result of intensive research and development.

Bonding Stability

Combining a unique dense bonding process (inhibiting ligand cleavage at low pH) with a revolutionary capping process (shielding the silica from dissolution at high pH) enables Hichrom C8 and C18 columns to offer exceptional stability across an extended pH range. Figure 5 demonstrates the acid robustness of a Hichrom 5 C18 column.

Column Robustness

A stable packed silica bed is critical to the long term performance of the column. Hichrom C8 and C18 columns are packed to extremely high efficiencies with excellent peak asymmetries, ensuring that high performance is maintained throughout the column's lifetime. Figure 6 shows that the performance of both Hichrom 3.5µm C18 and Hichrom 5µm C18 columns remains unaffected after extended use.

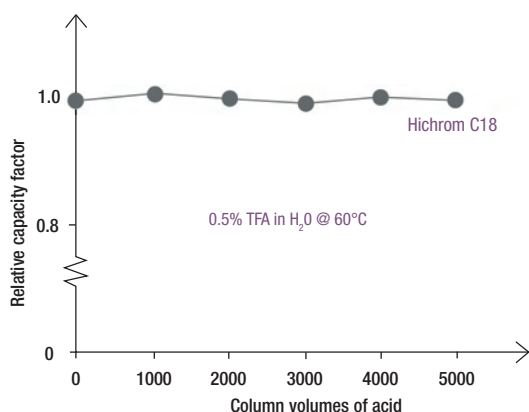

Figure 5. Acid robustness testing

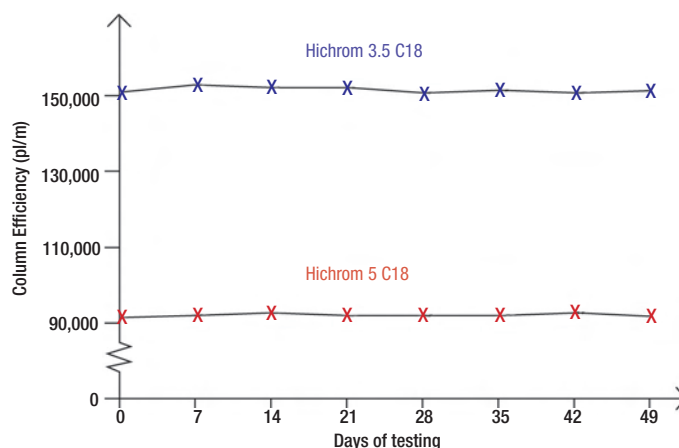

Figure 6. Extended column testing

Guard Cartridges

Guard cartridges are available for all Hichrom C8 and C18 column dimensions, to further extend column lifetime by preventing irreversible adsorption and frit blockage at the top of the column. As shown in Figure 7, a fingertight column coupler (HI-081) is used to connect the guard holder (HI-161) to a Hichrom 5 C18 column. Further information on the guard cartridge range is listed on pages 20 and 21.

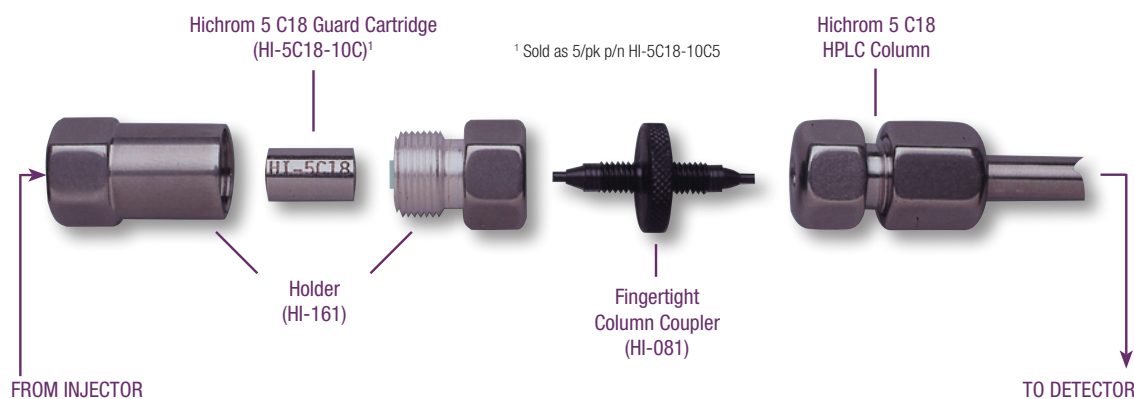

Figure 7. Stand alone guard cartridge system

Ordering Information - Hichrom C8 and C18 Microbore (1.0mm i.d.) Columns

Hichrom Phase	Column Dimensions ¹ (mm)				Guard Cartridges ^{2,3} (For 1.0mm i.d. Columns)
	50 x 1.0	100 x 1.0	150 x 1.0	250 x 1.0	
3.5µm					
C8	HI-3.5C8-50M	HI-3.5C8-100M	HI-3.5C8-150M	-	HI-3.5C8-10CE5
C18	HI-3.5C18-50M	HI-3.5C18-100M	HI-3.5C18-150M	-	HI-3.5C18-10CE5
5µm					
C8	HI-5C8-50M	HI-5C8-100M	HI-5C8-150M	HI-5C8-250M	HI-5C8-10CE5
C18	HI-5C18-50M	HI-5C18-100M	HI-5C18-150M	HI-5C18-250M	HI-5C18-10CE5

Microbore (2.1mm i.d.) Columns

Hichrom Phase	Column Dimensions ¹ (mm)				Guard Cartridges ^{2,3} (For 2.1mm i.d. Columns)
	50 x 2.1	100 x 2.1	150 x 2.1	250 x 2.1	
3.5µm					
C8	HI-3.5C8-50AM	HI-3.5C8-100AM	HI-3.5C8-150AM	-	HI-3.5C8-10CM5
C18	HI-3.5C18-50AM	HI-3.5C18-100AM	HI-3.5C18-150AM	-	HI-3.5C18-10CM5
5µm					
C8	HI-5C8-50AM	HI-5C8-100AM	HI-5C8-150AM	HI-5C8-250AM	HI-5C8-10CM5
C18	HI-5C18-50AM	HI-5C18-100AM	HI-5C18-150AM	HI-5C18-250AM	HI-5C18-10CM5

Medium Bore (3.2mm i.d.) Columns

Hichrom Phase	Column Dimensions ¹ (mm)				Guard Cartridges ^{2,3} (For 3.2mm i.d. Columns)
	50 x 3.2	100 x 3.2	150 x 3.2	250 x 3.2	
3.5µm					
C8	HI-3.5C8-50AS	HI-3.5C8-100AS	HI-3.5C8-150AS	-	HI-3.5C8-10C5
C18	HI-3.5C18-50AS	HI-3.5C18-100AS	HI-3.5C18-150AS	-	HI-3.5C18-10C5
5µm					
C8	HI-5C8-50AS	HI-5C8-100AS	HI-5C8-150AS	HI-5C8-250AS	HI-5C8-10C5
C18	HI-5C18-50AS	HI-5C18-100AS	HI-5C18-150AS	HI-5C18-250AS	HI-5C18-10C5

Analytical (4.0mm i.d.) Columns

Hichrom Phase	Column Dimensions ¹ (mm)				Guard Cartridges ^{2,3} (For 4.0mm i.d. Columns)
	50 x 4.0	100 x 4.0	150 x 4.0	250 x 4.0	
3.5µm					
C8	HI-3.5C8-50AF	HI-3.5C8-100AF	HI-3.5C8-150AF	-	HI-3.5C8-10C5
C18	HI-3.5C18-50AF	HI-3.5C18-100AF	HI-3.5C18-150AF	-	HI-3.5C18-10C5
5µm					
C8	HI-5C8-50AF	HI-5C8-100AF	HI-5C8-150AF	HI-5C8-250AF	HI-5C8-10C5
C18	HI-5C18-50AF	HI-5C18-100AF	HI-5C18-150AF	HI-5C18-250AF	HI-5C18-10C5

Analytical (4.6mm i.d.) Columns

Hichrom Phase	Column Dimensions ¹ (mm)				Guard Cartridges ^{2,3} (For 4.6mm i.d. Columns)
	50 x 4.6	100 x 4.6	150 x 4.6	250 x 4.6	
3.5µm					
C8	HI-3.5C8-50A	HI-3.5C8-100A	HI-3.5C8-150A	-	HI-3.5C8-10C5
C18	HI-3.5C18-50A	HI-3.5C18-100A	HI-3.5C18-150A	-	HI-3.5C18-10C5
5µm					
C8	HI-5C8-50A	HI-5C8-100A	HI-5C8-150A	HI-5C8-250A	HI-5C8-10C5
C18	HI-5C18-50A	HI-5C18-100A	HI-5C18-150A	HI-5C18-250A	HI-5C18-10C5

Semi-Preparative (7.75mm i.d.) Columns

Hichrom Phase	Column Dimensions ¹ (mm)				Guard Cartridges ⁴ (For 7.75mm i.d. Columns)
	50 x 7.75	100 x 7.75	150 x 7.75	250 x 7.75	
5µm					
C8	HI-5C8-50SP	HI-5C8-100SP	HI-5C8-150SP	HI-5C8-250SP	HI-5C8-10CP3
C18	HI-5C18-50SP	HI-5C18-100SP	HI-5C18-150SP	HI-5C18-250SP	HI-5C18-10CP3

¹ Other column dimensions available – please enquire

² 5/pk – Use with free-standing holder HI-161 and column coupler HI-081 – see p. 20

³ Starter kits available – see p. 21

⁴ 3/pk – Use with free-standing holder HI-150 and column coupler HI-081 – see p. 20

Ordering Information - Hichrom C8 and C18 (continued)

Semi-Preparative (10.0mm i.d.) Columns

Hichrom Phase	Column Dimensions ¹ (mm)				Guard Cartridges ² (For 10.0mm i.d. Columns)
	50 x 10.0	100 x 10.0	150 x 10.0	250 x 10.0	
5µm					
C8	HI-5C8-50SP1	HI-5C8-100SP1	HI-5C8-150SP1	HI-5C8-250SP1	HI-5C8-10CP3
C18	HI-5C18-50SP1	HI-5C18-100SP1	HI-5C18-150SP1	HI-5C18-250SP1	HI-5C18-10CP3

Preparative (21.2mm i.d.) Columns

Hichrom Phase	Column Dimensions ¹ (mm)				Guard Cartridges ² (For 21.2mm i.d. Columns)
	50 x 21.2	100 x 21.2	150 x 21.2	250 x 21.2	
5µm					
C8	HI-5C8-50P	HI-5C8-100P	HI-5C8-150P	HI-5C8-250P	HI-5C8-10CP3
C18	HI-5C18-50P	HI-5C18-100P	HI-5C18-150P	HI-5C18-250P	HI-5C18-10CP3

Preparative (30.0mm i.d.) Columns

Hichrom Phase	Column Dimensions ¹ (mm)				Guard Cartridges ³ (For 30.0mm i.d. Columns)
	50 x 30.0	100 x 30.0	150 x 30.0	250 x 30.0	
5µm					
C8	HI-5C8-50P3	HI-5C8-100P3	HI-5C8-150P3	HI-5C8-250P3	HI-5C8-20CP
C18	HI-5C18-50P3	HI-5C18-100P3	HI-5C18-150P3	HI-5C18-250P3	HI-5C18-20CP

¹ Other column dimensions available – please enquire³ 1/pk – Use with free-standing holder HI-183 and column coupler HI-083² 3/pk – Use with free-standing holder HI-150 and column coupler HI-081

Hichrom RPB

- High purity base deactivated silica
- 3.5, 5 and 10µm particle sizes
- Unique C8/C18 multi-alkyl phase
- Excellent chromatography

Hichrom RPB is a high purity base deactivated silica which offers a unique selectivity due to the proprietary C8/C18 multi-alkyl bonding and exhaustive endcapping employed. The range includes 3.5, 5 and 10µm phases, which are suitable for LC-MS applications and preparative separations respectively.

Phase	Functional Group	Endcapped	Particle Size (µm)	Pore Size (Å)	Surface Area (m ² /g)	Carbon Load (%)
RPB	C8/C18 multi-alkyl	Yes	3.5, 5, 10	110	340	14

Hichrom RPB is specifically designed for the **Reversed-Phase** separation of **Basic** molecules. The use of organic modifiers is minimised.

Residual acidic sites have been eliminated whilst monolayer coverage of the high purity silica surface has been retained to obtain optimum plate efficiency. Both octyl- and octadecylsilanes are bonded to give a material which combines the robustness of a C18 phase with the high coverage of a C8 phase.

Excellent peak shapes are obtained for basic drug molecules. In addition, acids and bases can be similarly chromatographed under suitably buffered conditions (see Figure 1).

Column: Hichrom RPB (250 x 4.6mm)
Eluent: CH₃OH - 0.004M KH₂PO₄, pH 3.0 (70:30)
Flow rate: 1ml/min

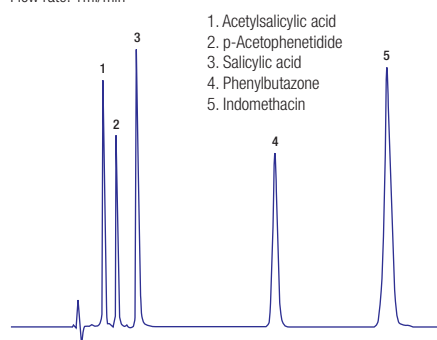

Figure 1. Chromatography of acidic and basic molecules

5µm RPB - 94,000 plates/metre

3.5µm RPB - 151,000 plates/metre

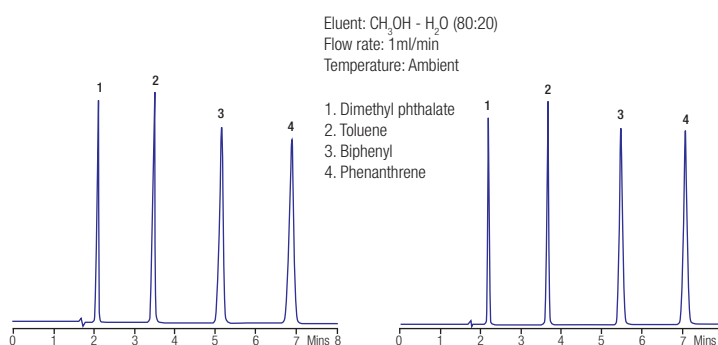

Figure 2. Reduce particle size to increase column efficiency

High Efficiency Columns:

- 3.5µm > 145,000 plates/metre
- 5µm > 90,000 plates/metre
- 10µm > 50,000 plates/metre

Hichrom 3.5µm RPB allows the chromatographer to decrease column length without sacrificing efficiency. This results in increased productivity due to reduced analysis time. Figure 2 compares the efficiency obtained under standard quality control conditions for 150 x 4.6mm i.d. Hichrom 5µm RPB and Hichrom 3.5µm RPB columns.

Ordering Information - Hichrom RPB

Microbore (1.0mm i.d.) Columns

Hichrom Phase	Column Dimensions ¹ (mm)				Guard Cartridges ^{2,3} (For 1.0mm i.d. Columns)
	50 x 1.0	100 x 1.0	150 x 1.0	250 x 1.0	
3.5µm RPB	HI-3.5RPB-50M	HI-3.5RPB-100M	HI-3.5RPB-150M	-	HI-3.5RPB-10CE5
5µm RPB	HIRPB-50M	HIRPB-100M	HIRPB-150M	HIRPB-250M	HIRPB-10CE5

¹ Other column dimensions available – please enquire

² Use with free-standing holder HI-161 and column coupler HI-081 – see p. 20

³ 5/pk – Starter kits available – see p. 21

Ordering Information - Hichrom RPB (continued)

Microbore (2.1mm i.d.) Columns

Hichrom Phase	Column Dimensions ¹ (mm)				Guard Cartridges ^{2,3} (For 2.1mm i.d. Columns)
	50 x 2.1	100 x 2.1	150 x 2.1	250 x 2.1	
3.5µm RPB	HI-3.5RPB-50AM	HI-3.5RPB-100AM	HI-3.5RPB-150AM	-	HI-3.5RPB-10CM5
5µm RPB	HIRPB-50AM	HIRPB-100AM	HIRPB-150AM	HIRPB-250AM	HIRPB-10CM5

Medium Bore (3.2mm i.d.) Columns

Hichrom Phase	Column Dimensions ¹ (mm)				Guard Cartridges ^{2,3} (For 3.2mm i.d. Columns)
	50 x 3.2	100 x 3.2	150 x 3.2	250 x 3.2	
3.5µm RPB	HI-3.5RPB-50AS	HI-3.5RPB-100AS	HI-3.5RPB-150AS	-	HI-3.5RPB-10C5
5µm RPB	HIRPB-50AS	HIRPB-100AS	HIRPB-150AS	HIRPB-250AS	HIRPB-10C5

Analytical (4.0mm i.d.) Columns

Hichrom Phase	Column Dimensions ¹ (mm)				Guard Cartridges ^{2,3} (For 4.0mm i.d. Columns)
	50 x 4.0	100 x 4.0	150 x 4.0	250 x 4.0	
3.5µm RPB	HI-3.5RPB-50AF	HI-3.5RPB-100AF	HI-3.5RPB-150AF	-	HI-3.5RPB-10C5
5µm RPB	HIRPB-50AF	HIRPB-100AF	HIRPB-150AF	HIRPB-250AF	HIRPB-10C5

Analytical (4.6mm i.d.) Columns

Hichrom Phase	Column Dimensions ¹ (mm)				Guard Cartridges ^{2,3} (For 4.6mm i.d. Columns)
	50 x 4.6	100 x 4.6	150 x 4.6	250 x 4.6	
3.5µm RPB	HI-3.5RPB-50A	HI-3.5RPB-100A	HI-3.5RPB-150A	-	HI-3.5RPB-10C5
5µm RPB	HIRPB-50A	HIRPB-100A	HIRPB-150A	HIRPB-250A	HIRPB-10C5
10µm RPB	HI-10RPB-50A	HI-10RPB-100A	HI-10RPB-150A	HI-10RPB-250A	HI-10RPB-10C5

Semi-Preparative (7.75mm i.d.) Columns

Hichrom Phase	Column Dimensions ¹ (mm)				Guard Cartridges ⁴ (For 7.75mm i.d. Columns)
	50 x 7.75	100 x 7.75	150 x 7.75	250 x 7.75	
5µm RPB	HIRPB-50SP	HIRPB-100SP	HIRPB-150SP	HIRPB-250SP	HIRPB-10CP3
10µm RPB	HI-10RPB-50SP	HI-10RPB-100SP	HI-10RPB-150SP	HI-10RPB-250SP	HI-10RPB-10CP3

Semi-Preparative (10.0mm i.d.) Columns

Hichrom Phase	Column Dimensions ¹ (mm)				Guard Cartridges ⁴ (For 10.0mm i.d. Columns)
	50 x 10.0	100 x 10.0	150 x 10.0	250 x 10.0	
5µm RPB	HIRPB-50SP1	HIRPB-100SP1	HIRPB-150SP1	HIRPB-250SP1	HIRPB-10CP3
10µm RPB	HI-10RPB-50SP1	HI-10RPB-100SP1	HI-10RPB-150SP1	HI-10RPB-250SP1	HI-10RPB-10CP3

Preparative (21.2mm i.d.) Columns

Hichrom Phase	Column Dimensions ¹ (mm)				Guard Cartridges ⁴ (For 21.2mm i.d. Columns)
	50 x 21.2	100 x 21.2	150 x 21.2	250 x 21.2	
5µm RPB	HIRPB-50P	HIRPB-100P	HIRPB-150P	HIRPB-250P	HIRPB-10CP3
10µm RPB	HI-10RPB-50P	HI-10RPB-100P	HI-10RPB-150P	HI-10RPB-250P	HI-10RPB-10CP3

Preparative (30.0mm i.d.) Columns

Hichrom Phase	Column Dimensions ¹ (mm)				Guard Cartridges ⁵ (For 30.0mm i.d. Columns)
	50 x 30.0	100 x 30.0	150 x 30.0	250 x 30.0	
5µm RPB	HIRPB-50P3	HIRPB-100P3	HIRPB-150P3	HIRPB-250P3	HIRPB-20CP ⁶
10µm RPB	HI-10RPB-50P3	HI-10RPB-100P3	HI-10RPB-150P3	HI-10RPB-250P3	HI-10RPB-20CP ⁶

¹ Other column dimensions available – please enquire² Use with free-standing holder HI-161 and column coupler HI-081 – see p. 20³ 5/pk – Starter kits available – see p. 21⁴ 3/pk – Use with free-standing holder HI-150 and column coupler HI-081⁵ 1/pk – Use with free-standing holder HI-183 and column coupler HI-083⁶ A newer improved holder HI-655 for use with new guards HIRPB-10CB3 or HI-10RPB-10CB3 is now available

Hichrom PAH2

- Optimised for EPA Method 610
- Excellent separation of 16 PAHs
- Wide range of column dimensions

Hichrom PAH2 Phase

Particle Size (μm)	5
Pore Size (\AA)	120
Endcapped	Yes



Polynuclear aromatic hydrocarbons (PAHs) are important environmental pollutants due to their ubiquitous presence and their carcinogenicity. They are produced by the incomplete combustion and pyrolysis of fossil fuels and other organic material eg. coal-tar pitch. These compounds are routinely analysed in industrial waste water, drinking water and ground water, solid waste, air, particulate matter and food samples.

Due to government legislation, environmental laboratories are required to perform an increasing number of PAH analyses, from a variety of matrices. Many countries have their own government legislation. In England and Wales, all water intended for human consumption must be screened for five indicator PAHs (compounds 11, 12, 13, 15 and 16 shown below). The US Environmental Protection Agency (EPA) has designated 16 priority pollutant PAHs that are indicative of PAH contamination or pollution. Methods based on these compounds, such as EPA 610 for PAH analysis in waste water and EPA 550 (drinking water), are universally accepted.

Hichrom PAH2 is based on an alkyl bonded silica material with a high carbon loading, designed specifically for the analysis of PAHs. Figure 1 shows the separation of 16 priority pollutants in just over 30 minutes.

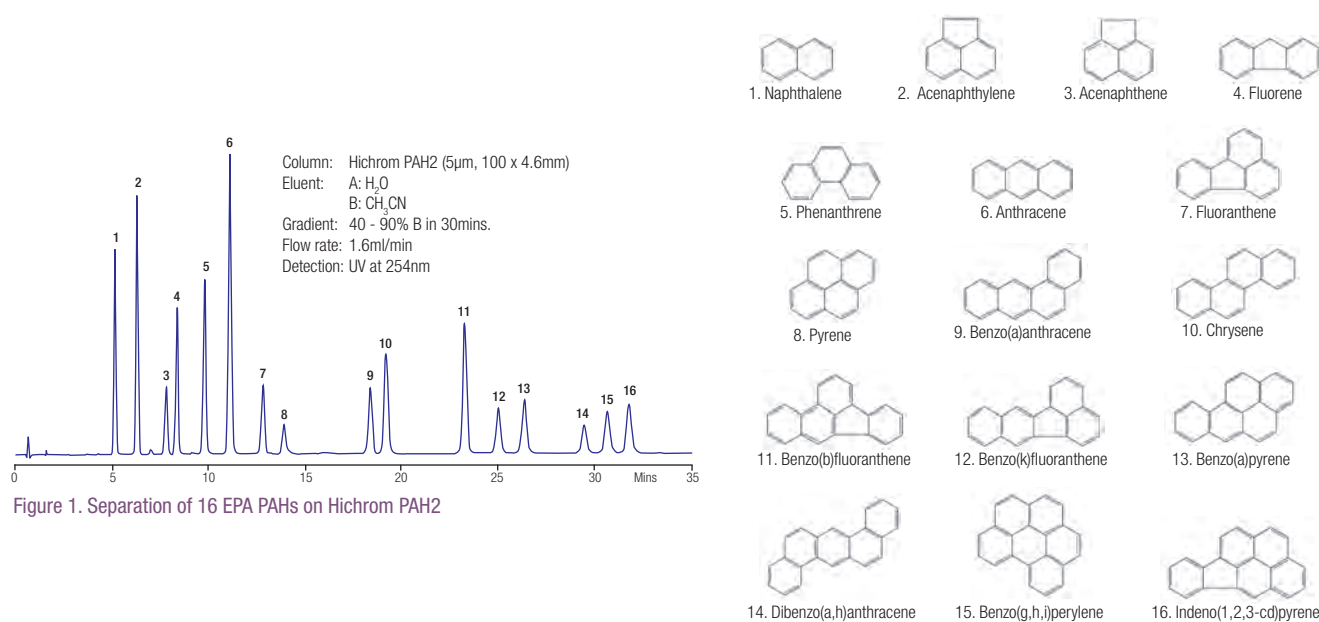

Figure 1. Separation of 16 EPA PAHs on Hichrom PAH2

Ordering Information – Hichrom PAH2

Column i.d.	Column Length ¹ (mm)			Guard Cartridges ^{2,3}
	100	150	250	
2.1	HI-5PAH2-100AM	HI-5PAH2-150AM	HI-5PAH2-250AM	HI-5PAH2-10CM5
3.2	HI-5PAH2-100AS	HI-5PAH2-150AS	HI-5PAH2-250AS	HI-5PAH2-10C5
4.6	HI-5PAH2-100A	HI-5PAH2-150A	HI-5PAH2-250A	HI-5PAH2-10C5

¹ Other column dimensions available – please enquire

² Use with free-standing holder HI-161 and column coupler HI-081 – see p. 20

³ 5/pk – Starter kits also available – see p. 21

HICHROM CHIRAL COLUMNS

- Chiral 'Pirkle-type'
- Unique covalent bonding
- Enantiomer elution order inversion
- Competitively priced
- Hichrom high efficiency

Hichrom manufactures two ranges of 'Pirkle-type' columns for the analysis of a wide range of enantiomers of pharmaceutical or agrochemical origin. CHIRA-chrom 1 type columns contain a stationary phase in which the hydroxyl groups on the silica surface have been modified by a nitrobenzoyl derivative of an optically active amino acid. In the CHIRA-chrom 2 type columns a chiral dinitrophenyltartramide moiety is bonded to the silica surface through a propyl spacer group.

Pirkle Chiral Phases

Phase	Type	Endcapped	Particle Size (µm)
D-Phenylglycine	CHIRA-chrom-1	No	5
L-Phenylglycine	CHIRA-chrom-1	No	5
DL-Phenylglycine	CHIRA-chrom-1	No	5
L-Leucine	CHIRA-chrom-1	No	5
Dinitrophenyltartramide	CHIRA-chrom-2	No	5

Inversion of enantiomer elution order

By substituting L-phenylglycine for D-phenylglycine, the order of elution of the chiral peaks can be reversed. Such a procedure can be useful in assigning peak identity or ensuring prior elution of the minor enantiomer, thus allowing its more accurate determination. The availability of the DL-phenylglycine further aids peak assignment by removing chiral separations whilst maintaining background peak retention profile.

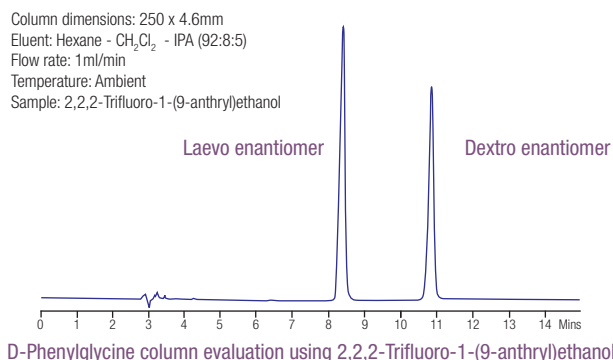

Ordering Information

Please contact Hichrom for details of additional column dimensions not listed.

Chiral Phase	Column Dimensions (mm)			Guard Cartridge ^{1,2} (For 3.2-4.6mm i.d. Columns)	Guard Cartridge ³ (For 7.75mm i.d. Columns)
	250 x 3.2	250 x 4.6	250 x 7.75		
D-Phenylglycine	CHI-D-PGC-250AS	CHI-D-PGC-250A	CHI-D-PGC-250SP	CHI-D-PGC-10C5	CHI-D-PGC-10CP3
L-Phenylglycine	CHI-L-PGC-250AS	CHI-L-PGC-250A	CHI-L-PGC-250SP	CHI-L-PGC-10C5	CHI-L-PGC-10CP3
DL-Phenylglycine	CHI-DL-PGC-250AS	CHI-DL-PGC-250A	CHI-DL-PGC-250SP	CHI-DL-PGC-10C5	CHI-DL-PGC-10CP3
L-Leucine	CHI-L-LEUC-250AS	CHI-L-LEUC-250A	CHI-L-LEUC-250SP	CHI-L-LEU-10C5	CHI-L-LEU-10CP3
Phenyltartramide	CHI-TA-250AS	CHI-TA-250A	CHI-TA-250SP	CHI-TA-10C5	CHI-TA-10CP3

¹ 5/pk – Use with free-standing holder HI-161 and column coupler HI-081 – see p. 20

² Starter kits also available – see p. 21

³ 3/pk – Use with free-standing holder HI-150 and column coupler HI-081

L-COLUMN

- C18 and C8 phases
- Super endcapped
- ODS-V validated phase
- L-column2 phases with improved endcapping

The L-column and L-column2 series of columns are manufactured by CERl (Chemicals Evaluation and Research Institute, Japan).

Series	Phase	Particle Size (µm)	Pore Size (Å)	Surface Area (m ² /g)	Carbon Load (%)	Endcapped
L-column2 ¹	L-column2 ODS	2, 3, 5	120	340	17	Yes
	L-column2 C8	5	120	340	10	Yes
L-column	ODS	3, 5	120	340	17	Yes
	ODS-V	5	120	340	17	Yes
	C8	5	120	340	10	Yes

¹ L-column2 C6-Phenyl also available – please enquire

L-column packing materials are endcapped by high temperature gaseous phase silylation (super endcapping; US Patent No. 5,134,110, Japan Patent No. 2611545), which allows a nearly complete deactivation of residual silanols. As a result, L-columns show no peak tailing of basic compounds and high durability (pH range of C18 is 2 - 9, pH range of C8 is 2 - 7.5).

L-column ODS-V

L-column ODS-V has been developed for complying with method validation required by GLP/GMP. Batch-to-batch and column-to-column reproducibility are controlled by strict quality control of manufacturing and testing procedures.

L-column2 ODS and C8

L-column2 ODS and C8 columns form part of a newer generation of columns, showing higher performance than their L-column counterparts, due to advanced endcapping methodology. They show sharper peaks for acidic, basic and chelating compounds.

Ordering Information

Phase	Column Dimensions ^{1,2} (mm)							
	50 x 2.1	100 x 2.1	150 x 2.1	250 x 2.1	50 x 4.6	100 x 4.6	150 x 4.6	250 x 4.6
3µm								
L-column2 ODS	711140	711170	711020	711220	721150	721180	721070	721080
L-column ODS	611140	611170	611020	611220	621150	621180	621070	621080
5µm								
L-column2 ODS	712140	712170	712020	712220	722150	722180	722070	722080
L-column2 C8	712141	712171	712021	712221	722151	722181	722071	722081
L-column ODS	612140	612170	612020	612220	622150	622180	622070	622080
L-column C8	612141	612171	612021	612221	622151	622181	622071	622081
L-column ODS-V	-	-	-	-	-	-	622078	622088

¹ Other dimensions available, including capillary and preparative

² Guard cartridges available

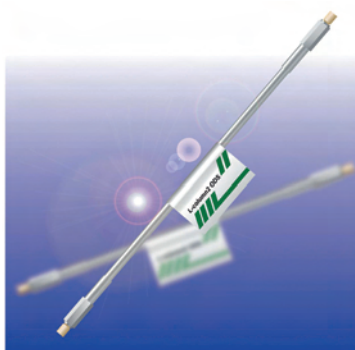

Macherey-Nagel GmbH & Co. KG manufactures a wide range of HPLC products for different techniques and applications. NUCLEOSIL® was one of the first commercially available spherical silicas, but is still used in many analytical and preparative applications. NUCLEODUR® is Macherey-Nagel's newer range of HPLC and UHPLC phases and NUCLEOSHELL® is a range of phases based on core shell (superficially porous) technology. Other Macherey-Nagel LC products include NUCLEOGEN® columns for bioanalysis, NUCLEOGEL® columns for food analysis and several types of chiral phases. Please see later sections or contact us for other Macherey-Nagel products including GC, SPE, TLC and Flash.

NUCLEOSIL®

NUCLEOSIL is a classical silica, available in a wide range of pore sizes. Please see page 103 for specifications of available phases and ordering information for Hichrom packed NUCLEOSIL columns.

NUCLEODUR®

The NUCLEODUR range of UHPLC and HPLC phases is based on state-of-the-art silica, offering outstanding particle surface smoothness, high pressure stability and low metal content. Phases have a pore size of 110Å, surface area of 340m²/g and are available with particle sizes of 1.8, 3 and 5µm. All phases show excellent mechanical and chemical stability and are LC-MS compatible. Phases include:

- **NUCLEODUR C18 Isis** – C18 with special cross-linked surface modification, leading to high steric selectivity
- **NUCLEODUR Sphinx RP** – a bifunctional phase consisting of C18 and propylphenyl groups
- **NUCLEODUR C18 Pyramid** – C18 with hydrophilic endcapping
- **NUCLEODUR PolarTec** – a C18 phase with an embedded polar group
- **NUCLEODUR Phenyl-Hexyl** – suitable for aromatic, unsaturated and polar compounds
- **NUCLEODUR HILIC** – a zwitterionic modified phase with ammonium-sulphonic acid ligands

Other NUCLEODUR phases include:

C18 Gravity, C8 Gravity, C18ec, C8ec, C18 PAH, C18 HTec, PFP, CN and CN-RP, NH₂ and NH₂-RP and Silica

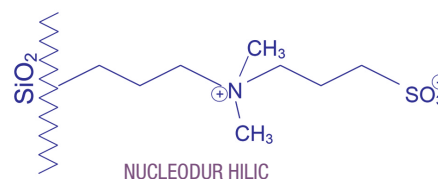

NUCLEOSHELL®

NUCLEOSHELL phases consist of a solid silica core (1.7µm) with a homogeneous shell of porous silica, giving an overall particle size of 2.7µm. These superficially porous particles produce higher efficiencies compared with traditional totally porous 3µm materials. The lower back pressure achieved enables the columns to be used with both UHPLC and HPLC instruments. Four phases are available:

- **NUCLEOSHELL RP 18** – suitable for LC-MS and HPLC at pH extremes (1 - 11)
- **NUCLEOSHELL HILIC** – a zwitterionic phase based on ammonium-sulphonic acid modified silica
- **NUCLEOSHELL PFP** – separates components due to H-bonding, dipole-dipole interactions, $\pi - \pi$ interactions and hydrophobic interactions
- **NUCLEOSHELL Phenyl-Hexyl** - suitable for aromatic, unsaturated and polar compounds

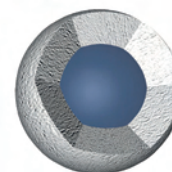

NUCLEOGEN® Columns for Bioanalysis

These are 7µm silica based anion-exchange phases, with diethylaminoethyl (DEAE) bonding. Phases are available with pore sizes of 60, 500 and 4000Å.

- **NUCLEOGEN 60-7 DEAE** – for separation of oligonucleotides up to chain length of 40 bases
- **NUCLEOGEN 500-7 DEAE** – for separation of RNA, viroids in molecular weight range 25,000 to 1,000,000 Da
- **NUCLEOGEN 4000-7 DEAE** – for separation of plasmids, DNA restriction fragments, RNA

NUCLEOGEL® Columns for Food Analysis

The NUCLEOGEL Sugar 810 series is based on spherical sulphonated polystyrene-divinylbenzene resin in different ionic forms. Separations of carbohydrates, organic acids and other polar small molecules are achieved by a combination of ion exclusion, ion-exchange, size exclusion, ligand exchange and partition mechanisms. Available phases include:

- **NUCLEOGEL Sugar 810H** – Hydrogen ion form (USP L17) for separation of sugars, sugar alcohols and organic acids
- **NUCLEOGEL Sugar 810Ca** – Calcium ion form (USP L19) for separation of mono-, di- and oligosaccharides

Chiral Phases

Macherey-Nagel manufacture a number of chiral LC phases. These include NUCLEODEX, RESOLVOSIL, NUCLEOSIL CHIRAL-1 and NUCLEOCEL.

- **NUCLEODEX®** phases are based on NUCLEOSIL silica bonded with modified cyclodextrins as chiral selectors. Four different phases are available. In addition to determining enantiomeric purity, NUCLEODEX phases are also useful for the analysis of positional and cis/trans isomers.
- **RESOLVOSIL® BSA-7** was one of the first commercially available protein-bound columns to demonstrate optical resolution. It is based on 7µm NUCLEOSIL silica with a pore size of 300Å.
- **NUCLEOSIL® CHIRAL-1** is chemically bonded with an L-hydroxyproline Cu²⁺ complex and separates racemic molecules by ligand exchange HPLC.
- **NUCLEOCEL® DELTA** is a cellulose coated phase conforming to USP L40. Columns for normal-phase and reversed-phase applications are available and can separate a wide range of chiral compounds.

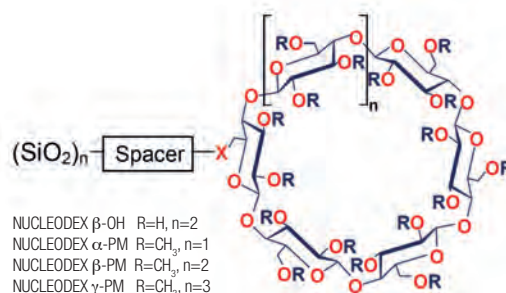

NUCLEOSIL®

- Spherical porous silica
- Wide range of bonded phases
- Excellent mechanical stability
- Hichrom high efficiency

NUCLEOSIL®, a classical silica manufactured by Macherey-Nagel GmbH & Co. KG, is available in a wide range of pore sizes. NUCLEOSIL 100Å and 120Å have similar relative retention characteristics. NUCLEOSIL 100Å has the greater capacity whilst the 120Å material exhibits the lower column back pressure. The wide pore NUCLEOSIL 300Å silica is used as the base material for the reversed-phase bioanalytical columns. NUCLEOSIL 100-5C18 AB was the first of the newer generation NUCLEOSIL materials which include the HD high density phases (please enquire for further details), NUCLEOSIL PROTECT 1 and Nautilus, for use with up to 100% aqueous eluents (see p.37).

NUCLEOSIL Silicas

Material	Pore Size (Å)	Surface Area (m ² /g)	Particle Size (µm)
NUCLEOSIL 100	100	350	3, 5, 7, 10
NUCLEOSIL 120	120	200	3, 5, 7, 10
NUCLEOSIL 300	300	100	5, 7, 10

NUCLEOSIL Phases

NUCLEOSIL Phase	Functional Group	Pore Size (Å)	Particle Size (µm)	Carbon Load (%)	Endcapped
C18	Octadecyl	100	3, 5, 7, 10	15	Yes
		120	3, 5, 7, 10	11	Yes
		300	5	6.5	Yes
C18 AB	Octadecyl, crosslinked	100	5	25	Yes
C8	Octyl	100	5, 7, 10	8.5	No
		120	3, 5, 7, 10	6.5	No
		300	5	3	No
C4	Butyl	300	5	2	Yes
C2	Dimethyl	100	7	3.5	No
Phenyl	Phenyl	100	5, 7	8	No
		120	5, 7	6.5	No
CN	Cyano	100	5, 10	5	No
		120	7		
NH ₂	Amino	100	5	3.5	No
		120	7		
NO ₂	Nitro	100	5	4.5	No
OH	Diol	100	5, 7	5	No
SA	Sulphonic acid	100	5, 10	6.5	No
SB	Quaternary ammonium	100	5, 10	10	No

Ordering Information – NUCLEOSIL 100Å – Hichrom Manufactured Columns

Microbore (1.0 – 2.1mm i.d.) Columns

Please contact Hichrom for further details of 1.0mm and 2.1mm i.d. NUCLEOSIL 100Å columns.

Medium Bore (3.2mm i.d.) Columns

NUCLEOSIL Phase	Column Dimensions ¹ (mm)				Guard Cartridges ^{2,3} (For 3.2mm i.d. Columns)
	50 x 3.2	100 x 3.2	150 x 3.2	250 x 3.2	
3µm					
100 3 Silica	NC100-3-50AS	NC100-3-100AS	NC100-3-150AS	NC100-3-250AS	NC100-3-10C5
100 3 C18	NC100-3C18-50AS	NC100-3C18-100AS	NC100-3C18-150AS	-	NC100-3C18-10C5
5µm					
100 5 Silica	NC100-5-50AS	NC100-5-100AS	NC100-5-150AS	NC100-5-250AS	NC100-5-10C5
100 5 C18	NC100-5C18-50AS	NC100-5C18-100AS	NC100-5C18-150AS	NC100-5C18-250AS	NC100-5C18-10C5
100 5 C8	NC100-5C8-50AS	NC100-5C8-100AS	NC100-5C8-150AS	NC100-5C8-250AS	NC100-5C8-10C5
100 5 CN	NC100-5CN-50AS	NC100-5CN-100AS	NC100-5CN-150AS	NC100-5CN-250AS	NC100-5CN-10C5
100 5 NH ₂	NC100-5NH-50AS	NC100-5NH-100AS	NC100-5NH-150AS	NC100-5NH-250AS	NC100-5NH-10C5
100 5 NO ₂	NC100-5NO-50AS	NC100-5NO-100AS	NC100-5NO-150AS	NC100-5NO-250AS	NC100-5NO-10C5
100 5 SA	NC100-5SA-50AS	NC100-5SA-100AS	NC100-5SA-150AS	NC100-5SA-250AS	NC100-5SA-10C5
100 5 SB	NC100-5SB-50AS	NC100-5SB-100AS	NC100-5SB-150AS	NC100-5SB-250AS	NC100-5SB-10C5
100 5 C18 AB	NC100-5C18AB-50AS	NC100-5C18AB-100AS	NC100-5C18AB-150AS	NC100-5C18AB-250AS	NC100-5C18AB-10C5

¹ Other column dimensions available – please enquire

² 5/pk - Use with free-standing holder HI-161 and column coupler HI-081 – see p. 20

³ Starter kits also available – see p. 21

Ordering Information – NUCLEOSIL® 100Å – Hichrom Manufactured Columns (continued)

Analytical (4.0mm i.d.) Columns

NUCLEOSIL Phase	Column Dimensions ¹ (mm)				Guard Cartridges ^{2,3} (For 4.0mm i.d. Columns)
	50 x 4.0	100 x 4.0	150 x 4.0	250 x 4.0	
3µm					
100 3 Silica	NC100-3-50AF	NC100-3-100AF	NC100-3-150AF	NC100-3-250AF	NC100-3-10C5
100 3 C18	NC100-3C18-50AF	NC100-3C18-100AF	NC100-3C18-150AF	NC100-3C18-250AF	NC100-3C18-10C5
5µm					
100 5 Silica	NC100-5-50AF	NC100-5-100AF	NC100-5-150AF	NC100-5-250AF	NC100-5-10C5
100 5 C18	NC100-5C18-50AF	NC100-5C18-100AF	NC100-5C18-150AF	NC100-5C18-250AF	NC100-5C18-10C5
100 5 C8	NC100-5C8-50AF	NC100-5C8-100AF	NC100-5C8-150AF	NC100-5C8-250AF	NC100-5C8-10C5
100 5 CN	NC100-5CN-50AF	NC100-5CN-100AF	NC100-5CN-150AF	NC100-5CN-250AF	NC100-5CN-10C5
100 5 NH2	NC100-5NH-50AF	NC100-5NH-100AF	NC100-5NH-150AF	NC100-5NH-250AF	NC100-5NH-10C5
100 5 NO2	NC100-5NO-50AF	NC100-5NO-100AF	NC100-5NO-150AF	NC100-5NO-250AF	NC100-5NO-10C5
100 5 SA	NC100-5SA-50AF	NC100-5SA-100AF	NC100-5SA-150AF	NC100-5SA-250AF	NC100-5SA-10C5
100 5 SB	NC100-5SB-50AF	NC100-5SB-100AF	NC100-5SB-150AF	NC100-5SB-250AF	NC100-5SB-10C5
100 5 C18 AB	NC100-5C18AB-50AF	NC100-5C18AB-100AF	NC100-5C18AB-150AF	NC100-5C18AB-250AF	NC100-5C18AB-10C5

Analytical (4.6mm i.d.) Columns

NUCLEOSIL Phase	Column Dimensions ¹ (mm)				Guard Cartridges ^{2,3} (For 4.6mm i.d. Columns)
	50 x 4.6	100 x 4.6	150 x 4.6	250 x 4.6	
3µm					
100 3 Silica	NC100-3-50A	NC100-3-100A	NC100-3-150A	NC100-3-250A	NC100-3-10C5
100 3 C18	NC100-3C18-50A	NC100-3C18-100A	NC100-3C18-150A	-	NC100-3C18-10C5
5µm					
100 5 Silica	NC100-5-50A	NC100-5-100A	NC100-5-150A	NC100-5-250A	NC100-5-10C5
100 5 C18	NC100-5C18-50A	NC100-5C18-100A	NC100-5C18-150A	NC100-5C18-250A	NC100-5C18-10C5
100 5 C8	NC100-5C8-50A	NC100-5C8-100A	NC100-5C8-150A	NC100-5C8-250A	NC100-5C8-10C5
100 5 CN	NC100-5CN-50A	NC100-5CN-100A	NC100-5CN-150A	NC100-5CN-250A	NC100-5CN-10C5
100 5 NH2	NC100-5NH-50A	NC100-5NH-100A	NC100-5NH-150A	NC100-5NH-250A	NC100-5NH-10C5
100 5 NO2	NC100-5NO-50A	NC100-5NO-100A	NC100-5NO-150A	NC100-5NO-250A	NC100-5NO-10C5
100 5 SA	NC100-5SA-50A	NC100-5SA-100A	NC100-5SA-150A	NC100-5SA-250A	NC100-5SA-10C5
100 5 SB	NC100-5SB-50A	NC100-5SB-100A	NC100-5SB-150A	NC100-5SB-250A	NC100-5SB-10C5
100 5 C18 AB	NC100-5C18AB-50A	NC100-5C18AB-100A	NC100-5C18AB-150A	NC100-5C18AB-250A	NC100-5C18AB-10C5
7µm					
100 7 Silica	NC100-7-50A	NC100-7-100A	NC100-7-150A	NC100-7-250A	NC100-7-10C5
100 7 C18	NC100-7C18-50A	NC100-7C18-100A	NC100-7C18-150A	NC100-7C18-250A	NC100-7C18-10C5
100 7 C8	NC100-7C8-50A	NC100-7C8-100A	NC100-7C8-150A	NC100-7C8-250A	NC100-7C8-10C5
100 7 C2	NC100-7C2-50A	NC100-7C2-100A	NC100-7C2-150A	NC100-7C2-250A	NC100-7C2-10C5
100 7 Phenyl	NC100-7P-50A	NC100-7P-100A	NC100-7P-150A	NC100-7P-250A	NC100-7P-10C5
100 7 Diol	NC100-7DIOL-50A	NC100-7DIOL-100A	NC100-7DIOL-150A	NC100-7DIOL-250A	NC100-7DIOL-10C5
10µm					
100 10 Silica	NC100-10-50A	NC100-10-100A	NC100-10-150A	NC100-10-250A	NC100-10-10C5
100 10 C18	NC100-10C18-50A	NC100-10C18-100A	NC100-10C18-150A	NC100-10C18-250A	NC100-10C18-10C5
100 10 C8	NC100-10C8-50A	NC100-10C8-100A	NC100-10C8-150A	NC100-10C8-250A	NC100-10C8-10C5
100 10 CN	NC100-10CN-50A	NC100-10CN-100A	NC100-10CN-150A	NC100-10CN-250A	NC100-10CN-10C5
100 10 SA	NC100-10SA-50A	NC100-10SA-100A	NC100-10SA-150A	NC100-10SA-250A	NC100-10SA-10C5
100 10 SB	NC100-10SB-50A	NC100-10SB-100A	NC100-10SB-150A	NC100-10SB-250A	NC100-10SB-10C5

¹ Other column dimensions available – please enquire² 5/pk - Use with free-standing holder HI-161 and column coupler HI-081 – see p. 20³ Starter kits also available – see p. 21

Semi-Preparative and Preparative (7.75 – 21.2mm i.d.) Columns

Please contact Hichrom for further details of 7.75-21.2mm i.d. NUCLEOSIL 100Å columns.

Ordering Information - NUCLEOSIL® 120Å – Hichrom Manufactured Columns

Microbore (1.0 – 2.1mm i.d.) Columns

Please contact Hichrom for further details of 1.0mm and 2.1mm i.d. NUCLEOSIL 120Å columns.

Medium Bore (3.2mm i.d.) Columns

NUCLEOSIL Phase	Column Dimensions ¹ (mm)				Guard Cartridges ^{2,3} (For 3.2mm i.d. Columns)
	50 x 3.2	100 x 3.2	150 x 3.2	250 x 3.2	
3µm					
120 3 Silica	NC120-3-50AS	NC120-3-100AS	NC120-3-150AS	NC120-3-250AS	NC120-3-10C5
120 3 C18	NC120-3C18-50AS	NC120-3C18-100AS	NC120-3C18-150AS	-	NC120-3C18-10C5
120 3 C8	NC120-3C8-50AS	NC120-3C8-100AS	NC120-3C8-150AS	-	NC120-3C8-10C5
5µm					
120 5 Silica	NC120-5-50AS	NC120-5-100AS	NC120-5-150AS	NC120-5-250AS	NC120-5-10C5
100 5 C18	NC120-5C18-50AS	NC120-5C18-100AS	NC120-5C18-150AS	NC120-5C18-250AS	NC120-5C18-10C5
100 5 C8	NC120-5C8-50AS	NC120-5C8-100AS	NC120-5C8-150AS	NC120-5C8-250AS	NC120-5C8-10C5

Analytical (4.0mm i.d.) Columns

NUCLEOSIL Phase	Column Dimensions ¹ (mm)				Guard Cartridges ^{2,3} (For 4.0mm i.d. Columns)
	50 x 4.0	100 x 4.0	150 x 4.0	250 x 4.0	
3µm					
120 3 Silica	NC120-3-50AF	NC120-3-100AF	NC120-3-150AF	NC120-3-250AF	NC120-3-10C5
120 3 C18	NC120-3C18-50AF	NC120-3C18-100AF	NC120-3C18-150AF	-	NC120-3C18-10C5
120 3 C8	NC120-3C8-50AF	NC120-3C8-100AF	NC120-3C8-150AF	-	NC120-3C8-10C5
5µm					
120 5 Silica	NC120-5-50AF	NC120-5-100AF	NC120-5-150AF	NC120-5-250AF	NC120-5-10C5
100 5 C18	NC120-5C18-50AF	NC120-5C18-100AF	NC120-5C18-150AF	NC120-5C18-250AF	NC120-5C18-10C5
100 5 C8	NC120-5C8-50AF	NC120-5C8-100AF	NC120-5C8-150AF	NC120-5C8-250AF	NC120-5C8-10C5

Analytical (4.6mm i.d.) Columns

NUCLEOSIL Phase	Column Dimensions ¹ (mm)				Guard Cartridges ^{2,3} (For 4.6mm i.d. Columns)
	50 x 4.6	100 x 4.6	150 x 4.6	250 x 4.6	
3µm					
120 3 Silica	NC120-3-50A	NC120-3-100A	NC120-3-150A	NC120-3-250A	NC120-3-10C5
120 3 C18	NC120-3C18-50A	NC120-3C18-100A	NC120-3C18-150A	-	NC120-3C18-10C5
120 3 C8	NC120-3C8-50A	NC120-3C8-100A	NC120-3C8-150A	-	NC120-3C8-10C5
5µm					
120 5 Silica	NC120-5-50A	NC120-5-100A	NC120-5-150A	NC120-5-250A	NC120-5-10C5
120 5 C18	NC120-5C18-50A	NC120-5C18-100A	NC120-5C18-150A	NC120-5C18-250A	NC120-5C18-10C5
120 5 C8	NC120-5C8-50A	NC120-5C8-100A	NC120-5C8-150A	NC120-5C8-250A	NC120-5C8-10C5
7µm					
120 7 C18	NC120-7C18-50A	NC120-7C18-100A	NC120-7C18-150A	NC120-7C18-250A	NC120-7C18-10C5
120 7 C8	NC120-7C8-50A	NC120-7C8-100A	NC120-7C8-150A	NC120-7C8-250A	NC120-7C8-10C5
120 7 Phenyl	NC120-7P-50A	NC120-7P-100A	NC120-7P-150A	NC120-7P-250A	NC120-7CP-10C5
120 7 CN	NC120-7CN-50A	NC120-7CN-100A	NC120-7CN-150A	NC120-7CN-250A	NC120-7CN-10C5
120 7 NH2	NC120-7NH-50A	NC120-7NH-100A	NC120-7NH-150A	NC120-7NH-250A	NC120-7NH-10C5
10µm					
120 10 C18	NC120-10C18-50A	NC120-10C18-100A	NC120-10C18-150A	NC120-10C18-250A	NC120-10C18-10C5
120 10 C8	NC120-10C8-50A	NC120-10C8-100A	NC120-10C8-150A	NC120-10C8-250A	NC120-10C8-10C5

¹ Other column dimensions available – please enquire

² 5/pk - Use with free-standing holder HI-161 and column coupler HI-081 – see p. 20

³ Starter kits also available – see p. 21

Ordering Information - NUCLEOSIL® 300Å – Hichrom Manufactured Columns

Microbore (1.0mm i.d.) Columns

Please contact Hichrom for further details of 1.0mm i.d. NUCLEOSIL 300Å columns.

Microbore (2.1mm i.d.) Columns

NUCLEOSIL Phase	Column Dimensions ¹ (mm)				Guard Cartridges ^{2,3} (For 2.1mm i.d. Columns)
	50 x 2.1	100 x 2.1	150 x 2.1	250 x 2.1	
5µm					
300 5 C4	NC300-5C4-50AM	NC300-5C4-100AM	NC300-5C4-150AM	NC300-5C4-250AM	NC300-5C4-10CM5
300 5 C8	NC300-5C8-50AM	NC300-5C8-100AM	NC300-5C8-150AM	NC300-5C8-250AM	NC300-5C8-10CM5
300 5 C18	NC300-5C18-50AM	NC300-5C18-100AM	NC300-5C18-150AM	NC300-5C18-250AM	NC300-5C18-10CM5

Medium Bore (3.2mm i.d.) Columns

NUCLEOSIL Phase	Column Dimensions ¹ (mm)				Guard Cartridges ^{2,3} (For 3.2mm i.d. Columns)
	50 x 3.2	100 x 3.2	150 x 3.2	250 x 3.2	
5µm					
300 5 C4	NC300-5C4-50AS	NC300-5C4-100AS	NC300-5C4-150AS	NC300-5C4-250AS	NC300-5C4-10C5
300 5 C8	NC300-5C8-50AS	NC300-5C8-100AS	NC300-5C8-150AS	NC300-5C8-250AS	NC300-5C8-10C5
300 5 C18	NC300-5C18-50AS	NC300-5C18-100AS	NC300-5C18-150AS	NC300-5C18-250AS	NC300-5C18-10C5

Analytical (4.0mm i.d.) Columns

Please contact Hichrom for further details of 4.0mm i.d. NUCLEOSIL 300Å columns.

Analytical (4.6mm i.d.) Columns

NUCLEOSIL Phase	Column Dimensions ¹ (mm)				Guard Cartridges ^{2,3} (For 4.6mm i.d. Columns)
	50 x 4.6	100 x 4.6	150 x 4.6	250 x 4.6	
5µm					
300 5 C4	NC300-5C4-50A	NC300-5C4-100A	NC300-5C4-150A	NC300-5C4-250A	NC300-5C4-10C5
300 5 C8	NC300-5C8-50A	NC300-5C8-100A	NC300-5C8-150A	NC300-5C8-250A	NC300-5C8-10C5
300 5 C18	NC300-5C18-50A	NC300-5C18-100A	NC300-5C18-150A	NC300-5C18-250A	NC300-5C18-10C5

¹ Other column dimensions available – please enquire

² 5/µk - Use with free-standing holder HI-161 and column coupler HI-081 – see p. 20

³ Starter kits also available – see p. 21

Semi-Preparative and Preparative Columns (7.75 – 21.2mm i.d.)

Please contact Hichrom for further details of 7.75 – 21.2mm i.d. NUCLEOSIL 300Å columns.

Please contact us for ordering details on all Macherey-Nagel columns not listed

- Polymeric phases
- Reversed-phase, ion-exchange, SEC phases
- Columns and bulk resins
- High chemical stability

The MCI GEL® range of polymeric phases, manufactured by Mitsubishi Chemicals, includes reversed-phase, ion-exchange, ion chromatography, chiral and size exclusion materials. These products are available as packed columns and bulk materials. The features of these MCI GEL phases are summarised below. Please contact Hichrom for ordering information for the bulk resins and chiral columns. Please see page 3 for new MCI GEL CHK40/C04 mixed-mode columns for polar molecule separation.

Columns for Low Molecular Weight Separations (eg. MW < 2000)

Columns for ion-exchange (CK and CA Series) – for MW < 2000

Matrix: styrene-divinylbenzene copolymer

MCI GEL Phase	Cross Linkage %	Counter Ion	Particle Size (µm)	Applications	Column Dimensions ¹ (mm)	Cat. No.
CK10U	10	Na ⁺	5	Amino acids, amines	120 x 6.0	001901
CK08S	8	Na ⁺	11	General sugar separations	500 x 8.0	000901
CK08E	8	Na ⁺	9	General sugar separations	300 x 8.0	001001
CK08EC	8	Ca ²⁺	9	General sugar separations, sugar alcohols	300 x 8.0	001002
CK08ES	8	Ag ⁺	9	-	300 x 8.0	001003
CK08EH	8	H ⁺	9	Carboxylic acids, sugar alcohols	300 x 8.0	001005
CK04S	4	Na ⁺	11	Oligosaccharides	200 x 10	000301
CK04SS	4	Ag ⁺	11	Oligosaccharides	200 x 10	000302
CK02A	2	Na ⁺	20	Oligosaccharides	250 x 20	000101
CK02AS	2	Ag ⁺	20	Oligosaccharides	250 x 20	000102
CA08F	8	Cl ⁻	7	Sugars, carboxylic acids, nucleotides	250 x 4.6	011101
CDR10	porous	AcO ⁻	7	Sugars, nucleotides from physiological fluids	250 x 4.6	011901

¹ Guard columns available

Columns for ion chromatography (SCK and SCA)

The MCI GEL ion chromatography columns are designed for non-suppressed ion chromatography applications.

Matrix: SCK01 – styrene-divinylbenzene copolymer, SCA04 – polyhydroxymethacrylate

MCI GEL Phase	Functional Group	Counter Ion	Particle Size (µm)	Applications	Column Dimensions ¹ (mm)	Cat. No.
SCK01	-SO ₃ ⁻	Na ⁺	11	Mono- and divalent cations, transition metals, nucleosides	50 x 6.0	003401
					150 x 4.6	003404
SCA04	Quaternary ammonium	Cl ⁻	5	Inorganic anions	150 x 4.6 ²	013302

¹ Guard columns available

² PEEK hardware

Column: MCI GEL SCK01 (50 x 6.0mm)
Eluent: 1.5mM tartaric acid, 0.8mM ethylenediamine
Flow rate: 1.0ml/min
Column temperature: 40°C
Detection: Conductivity

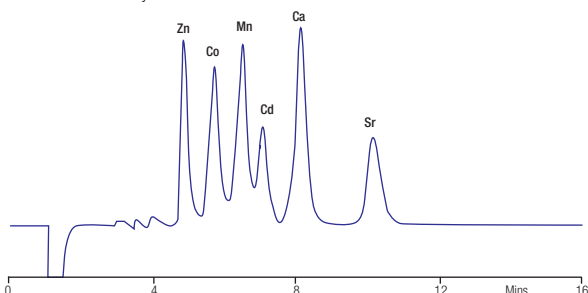

Figure 1. Transition metal analysis on MCI GEL SCK01

Column: MCI GEL SCA04 (50 x 6.0mm)
Eluent: 3mM potassium hydrogenphthalate
Flow rate: 1.2ml/min
Column temperature: 40°C
Detection: Conductivity

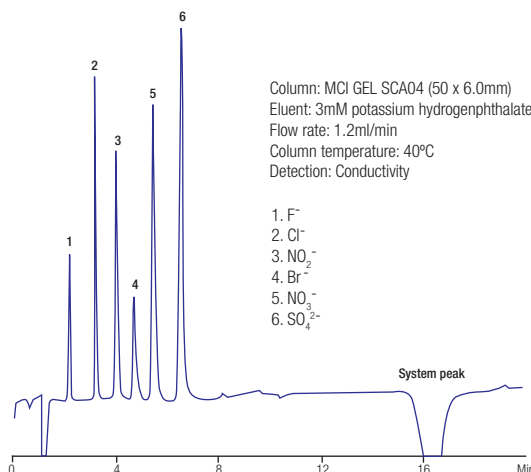

Figure 2. Anion analysis on MCI GEL SCA04

Columns for Low Molecular Weight Separations (eg. MW < 2000) (continued)

Columns for reversed-phase (CHP Series)

MCI GEL Phase	Matrix	Particle Size (µm)	Pore Size (Å)	pH Range	Column Dimensions (mm)	Cat. No.
CHP20/C04	PS-DVB	4	proprietary	1 - 13	150 x 4.6	040105
CHP20/C10	PS-DVB	10	250	1 - 13	250 x 4.6	040301
CMG20/C04	Hydroxypolymethacrylate	4	proprietary	2 - 12	150 x 4.6	040205
CMG20/C10	Hydroxypolymethacrylate	10	250	2 - 12	250 x 4.6	020205

Columns for Biopolymer Separations (eg. MW > 2000)

Columns for gel filtration (CQP Series)

Matrix: polyhydroxymethacrylate

MCI GEL Phase	Particle Size (µm)	Pore Size (Å)	Exclusion Limit PEG	Applications	Column Dimensions ¹ (mm)	Cat. No.
CQP06	10	120	10 ³	Proteins, peptides, enzymes and other biomolecules	600 x 7.5	021301
CQP10	10	200	10 ⁴		600 x 7.5	021401
CQP30	10	600	10 ⁶		600 x 7.5	021501

¹ Guard columns available

Columns for ion-exchange (CQA and CQK Series) – for MW > 2000

Matrix: polyhydroxymethacrylate

MCI GEL Phase	Functional Group	Counter Ion	Particle Size (µm)	Pore Size (Å)	pH Range	Applications	Column Dimensions (mm)	Cat. No.
CQA31S	Diethylaminoethyl	Cl ⁻	10	600	2 - 12	Proteins and peptides	75 x 7.5	012601
CQA35S	Quaternary ammonium	Cl ⁻	10	600	2 - 12		75 x 7.5	013001
CQK30S	Sulphopropyl	Na ⁺	10	600	1 - 13		75 x 7.5	003601
CQK31S	Carboxymethyl	Na ⁺	10	600	4 - 13		75 x 7.5	003801

Columns for hydrophobic interaction chromatography (CQH Series) – for MW > 2000

Matrix: polyhydroxymethacrylate

MCI GEL Phase	Functional Group	Particle Size (µm)	Pore Size (Å)	Applications	Column Dimensions (mm)	Cat. No.
CQH3ES	Ether	10	600	Proteins and peptides	75 x 7.5	021701
CQH3BS	Butyl	10	600		75 x 7.5	021601
CQH3PS	Phenyl	10	600		75 x 7.5	021801

MCI GEL® Bulk Media

MCI GEL® bulk packing materials include ion-exchange resins, size exclusion materials and non-functionalised polymer for reversed-phase separations. The availability of resins with particle sizes from 4 to greater than 100µm makes MCI GEL materials suitable for analytical to preparative applications.

Please contact Hichrom for further details of these materials.

Merck Millipore, a division of Merck KGaA, Darmstadt, Germany, manufactures a number of products for use in the life science industry. A brief overview of the Merck SeQuant® speciality HILIC phases, Chromolith® columns, Purospher® and Purospher STAR HPLC columns is given on the next couple of pages. Specifications and ordering details for LiChrosorb® and LiChrospher® columns are found on pages 111-113. Merck TLC plates are described on page 181. Please contact us for ordering information on any products not listed.

SeQuant ZIC-HILIC and ZIC-pHILIC

Merck SeQuant ZIC-HILIC and ZIC-pHILIC phases have been developed for the separation of polar and hydrophilic compounds in HILIC (Hydrophilic Interaction Liquid Chromatography) mode.

Phase	Base Material	Particle Size (µm)	Surface Area (m ² /g)	pH Stability	Max. Temp. (°C)
ZIC-HILIC 100Å	Spherical silica	3.5	180	3 - 8	70
ZIC-HILIC 200Å	Spherical silica	3.5, 5	130	3 - 8	70
ZIC-pHILIC	Polymeric	5	-	2 - 10	50

The ZIC-HILIC and ZIC-pHILIC phases have a bonded stationary phase consisting of a highly polar, permanent zwitterionic sulphobetaine structure (see Figure 1).

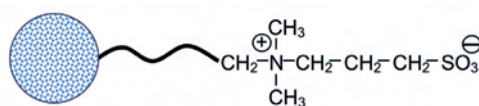

Figure 1. ZIC-HILIC phase

Separation selectivity is favoured by the 1:1 zwitterionic charge balance, which makes the column overall neutral, but with weak ionic interactions. Figure 2 shows the separation of morphine and its glucuronated metabolites on a ZIC-HILIC column.

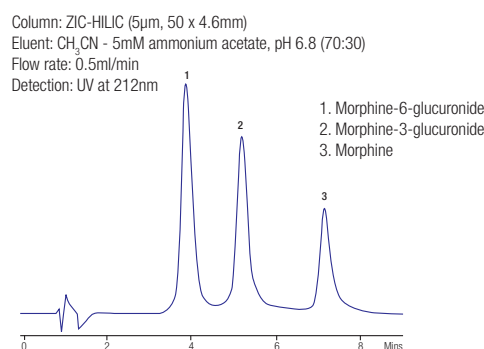

Figure 2. Separation of morphine and glucuronated metabolites

SeQuant ZIC-HILIC

ZIC-HILIC shows the highest separation efficiency and is suitable for most HILIC applications. Its key features include:

- 1) Orthogonality** Polar and hydrophilic compounds generally experience stronger retention on ZIC-HILIC than on reversed-phase columns.
- 2) LC-MS Compatibility** Since typical eluents for HILIC consist of 40-97% acetonitrile in water or volatile buffer, ZIC-HILIC columns are ideal for LC-MS analyses. By changing from reversed-phase to HILIC, a large increase in sensitivity is often observed for hydrophilic analytes.
- 3) Scalability** In addition to standard analytical and semi-preparative columns, the ZIC-HILIC range includes fused silica nano columns and glass-lined stainless steel capillary columns for down-scaling of methods. Methods developed on analytical ZIC-HILIC columns can also be successfully scaled up to preparative dimensions.
- 4) Rapid Resolution and High Throughput** A 3.5µm 20 x 2.1mm PEEK column is available for high throughput analyses.

SeQuant ZIC-pHILIC

The polymer-based ZIC-pHILIC phase comprises the same sulphobetaine type zwitterionic functional group as the ZIC-HILIC phase and offers similar selectivity to the ZIC-HILIC columns. However, it can be used in a wider pH range, thereby extending the classes of analytes that can be separated by HILIC. In addition, the selection of optimum ionisation conditions for MS sensitivity may be enhanced.

SeQuant ZIC-cHILIC

SeQuant ZIC-cHILIC is a newer zwitterionic stationary phase in which phosphorylcholine functional groups (rather than sulphobetaine groups) are bonded to the silica surface (see Figure 3).

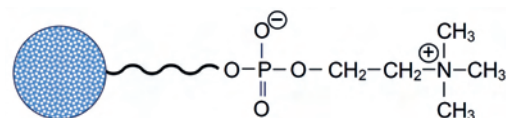

Figure 3. ZIC-cHILIC phase

This phase offers complementary selectivity to the ZIC-HILIC phase as well as to reversed-phase and other HILIC columns. The selectivity features are especially beneficial for analysing negatively charged polar compounds such as nucleosides and organic acids, but are also beneficial for the separation of positively charged hydrophilic molecules, including aminoglycosides and cations. Figure 4 illustrates the gradient separation of a mixture of five aminoglycoside antibiotics.

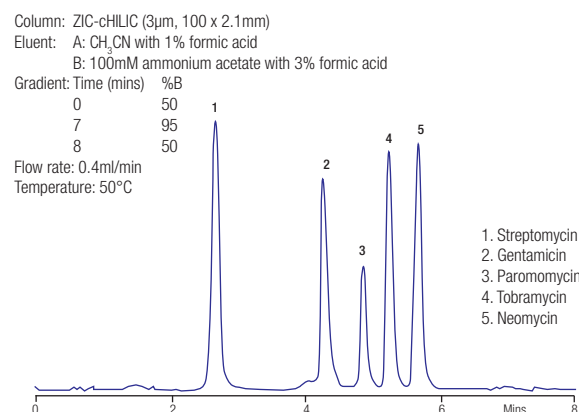

Figure 4. LC-MS of aminoglycoside antibiotics

ZIC-cHILIC and ZIC-HILIC, which have differently orientated zwitterionic functional groups, show different selectivity towards polar hydrophilic compounds.

Please contact us for ordering information on all Merck SeQuant HILIC phases.

Chromolith®

Chromolith® HPLC columns consist of monolithic rods made of highly porous metal-free silica. The rods are mechanically stable and chemically resistant. After derivatisation and endcapping the silica rods are clad in PEEK. Chromolith silica has a unique bimodal pore structure, consisting of a dense network of macropores, each 2µm in diameter, which reduces the column back-pressure and enables the use of faster flow rates. Within the skeletal structure of the rod is a further network of mesopores, each 13nm in diameter, which provides the large active surface area for high efficiency separations.

Chromolith phases include RP-18e, RP-18e HR (High Resolution), RP-8e, NH2 and Si.

Key Features of Chromolith Columns

- 1) Selectivity** Chromolith columns show comparable selectivity to conventional reversed-phase columns, so existing methods can be easily transferred with only minimal method development. However, retention times are shorter on Chromolith columns.
- 2) Speed of analysis** Separations twice as fast and at half the column back pressure compared to conventional reversed-phase 5µm columns can be achieved. Figure 5 shows the separation of a range of antihistamines on a Chromolith FastGradient RP-18e column.
- 3) Column coupling** Several Chromolith columns can be linked in series producing a column with a theoretical plate count significantly higher than particulate columns.
- 4) Flow programming** Chromolith columns are very responsive to changes in flow rate, due to fast re-equilibration. Flow rates can be changed in mid flow to shorten separation time once the target compound has successfully eluted.
- 5) Reduced sample preparation** Chromolith columns are very resistant to blocking, even with biological samples.
- 6) Scalability** Chromolith SemiPrep 10mm i.d. columns have the same bimodal porous silica rod structure as Chromolith analytical columns and are ideal for direct scale-up. For Chromolith Prep columns (100 x 25mm i.d.) the macropore size is 3µm and mesopore size is 12nm.

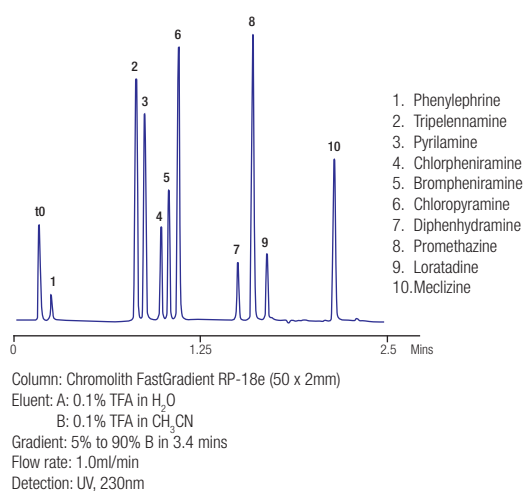
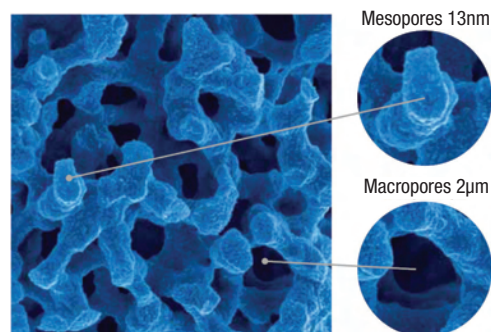

Figure 5. Ultra-fast separation of antihistamines

Purospher® and Purospher STAR Phases

The Purospher® range of HPLC columns is based on high purity metal-free silica. Phases include:

- RP-18 – an amino endcapped C18 for analysis of hydrophilic compounds, pore size 90Å
- RP-18e – C18 with hydrophobic endcapping, pore size 120Å
- RP-18 HC – non endcapped C18, suitable for analysis of explosives and related compounds

Purospher STAR phases are based on high purity silica for the separation of basic, neutral and metal-chelating samples. Available phases include:

- RP-18e and RP-8e – C18 and C8 respectively, both with hydrophobic endcapping, pore size of 120Å and particle sizes of 2, 3 and 5µm.
- Other phases – NH₂ and Si

Speciality Phases (Aluspher® RP-select B and ChiraDex® Chiral)

Aluspher® RP-select B is a reversed-phase material based on porous spherical alumina, the surface of which has been modified by polymer coating with polybutadiene. It is stable over the pH range 2 – 12, enabling the use of basic eluents such as NaOH. Working at high pH, the ionisation of basic compounds is suppressed and peak tailing is avoided.

ChiraDex® is based on β-cyclodextrin covalently linked to spherical silica particles. The phase shows broad enantioselectivity, with molecules separating depending on the extent of their complexation within the cyclodextrin cavities.

Merck Cartridge System

LiChrosorb, LiChrospher and Superspher are available in Merck's LiChroCART cartridge system used with manu-CART end fittings. These columns can be used with or without an integral guard cartridge. Please contact us for further details of available cartridges.

Please contact us for ordering information for Chromolith, Purospher and the other Merck phases listed.

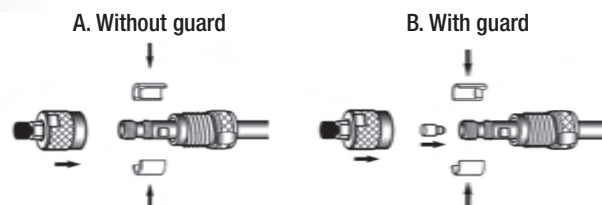

Figure 6. manu-CART cartridge end fittings

LiChrosorb®

- Irregular porous silica
- 5 and 10µm particle sizes
- Hichrom high efficiency packed columns

LiChrosorb® is a traditional silica manufactured by Merck Millipore and is available as 60 and 100Å pore size particles. It has been used in HPLC for over 25 years and is well documented in the literature. All Hichrom packed columns use industry standard compression fittings.

LiChrosorb Phases

LiChrosorb Phase	Functional Group	Endcapped	Particle Size (µm)	Pore Size (Å)	Surface Area (m ² /g)	Carbon Load (%)
Silica	-	-	5, 10	60	500	-
			10	100	300	-
RP-8	Octyl	No	5, 10	100	300	9.5
RP-18	Octadecyl	No	5, 10	100	300	16.2
CN	Cyano	No	5	100	300	7
NH ₂	Amino	No	5, 10	100	300	4
DIOL	Hydroxyl	No	5, 10	100	300	8

Ordering Information – Hichrom Manufactured Columns

Analytical (4.0mm i.d.) Columns

5µm LiChrosorb Phase	Column Dimensions ¹ (mm)					Guard Cartridges ^{2,3} (For 4.0mm i.d. columns)
	50 x 4.0	100 x 4.0	125 x 4.0	150 x 4.0	250 x 4.0	
Silica (60Å)	LI60-5-50AF	LI60-5-100AF	LI60-5-125AF	LI60-5-150AF	LI60-5-250AF	LI60-5-10C5
Silica (100Å)	LI100-5-50AF	LI100-5-100AF	LI100-5-125AF	LI100-5-150AF	LI100-5-250AF	LI100-5-10C5
RP-8	LIRP8-5-50AF	LIRP8-5-100AF	LIRP8-5-125AF	LIRP8-5-150AF	LIRP8-5-250AF	LIRP8-5-10C5
RP-18	LIRP18-5-50AF	LIRP18-5-100AF	LIRP18-5-125AF	LIRP18-5-150AF	LIRP18-5-250AF	LIRP18-5-10C5
CN	LICN-5-50AF	LICN-5-100AF	LICN-5-125AF	LICN-5-150AF	LICN-5-250AF	LICN-5-10C5
NH ₂	LINH-5-50AF	LINH-5-100AF	LINH-5-125AF	LINH-5-150AF	LINH-5-250AF	LINH-5-10C5
DIOL	LIOH-5-50AF	LIOH-5-100AF	LIOH-5-125AF	LIOH-5-150AF	LIOH-5-250AF	LIOH-5-10C5

Analytical (4.6mm i.d.) Columns

5µm LiChrosorb Phase	Column Dimensions ¹ (mm)					Guard Cartridges ^{2,3} (For 4.6mm i.d. columns)
	50 x 4.6	100 x 4.6	125 x 4.6	150 x 4.6	250 x 4.6	
Silica (60Å)	LI60-5-50A	LI60-5-100A	LI60-5-125A	LI60-5-150A	LI60-5-250A	LI60-5-10C5
Silica (100Å)	LI100-5-50A	LI100-5-100A	LI100-5-125A	LI100-5-150A	LI100-5-250A	LI100-5-10C5
RP-8	LIRP8-5-50A	LIRP8-5-100A	LIRP8-5-125A	LIRP8-5-150A	LIRP8-5-250A	LIRP8-5-10C5
RP-18	LIRP18-5-50A	LIRP18-5-100A	LIRP18-5-125A	LIRP18-5-150A	LIRP18-5-250A	LIRP18-5-10C5
CN	LICN-5-50A	LICN-5-100A	LICN-5-125A	LICN-5-150A	LICN-5-250A	LICN-5-10C5
NH ₂	LINH-5-50A	LINH-5-100A	LINH-5-125A	LINH-5-150A	LINH-5-250A	LINH-5-10C5
DIOL	LIOH-5-50A	LIOH-5-100A	LIOH-5-125A	LIOH-5-150A	LIOH-5-250A	LIOH-5-10C5

Analytical (4.0 and 4.6mm i.d.) Columns

10µm LiChrosorb Phase	Column Dimensions ¹ (mm)		Guard Cartridges ^{2,3} (For 4.0 and 4.6mm i.d. columns)
	250 x 4.0	250 x 4.6	
Silica (60Å)	LI60-10-250AF	LI60-10-250A	LI60-10-10C5
Silica (100Å)	LI100-10-250AF	LI100-10-250A	LI100-10-10C5
RP-8	LIRP8-10-250AF	LIRP8-10-250A	LIRP8-10-10C5
RP-18	LIRP18-10-250AF	LIRP18-10-250A	LIRP18-10-10C5
NH ₂	LINH-10-250AF	LINH-10-250A	LINH-10-10C5
DIOL	LIOH-10-250AF	LIOH-10-250A	LIOH-10-10C5

¹ Other column dimensions available – please enquire

² 5/pk – Use with free-standing holder HI-161 and column coupler HI-081 – see p.20

³ Starter kits also available – see p.21

LiChrospher®

- Spherical porous silica
- Base deactivated LiChrospher RP-select B
- Endcapping options for RP-8 and RP-18
- Hichrom high efficiency packed columns

LiChrospher® is a traditional silica manufactured by Merck Millipore. The availability of both endcapped and non-endcapped C8 and C18 phases significantly enhances the chromatographer's selectivity options. LiChrospher RP-select B was Merck's first generation base deactivated material. A range of 4µm materials has been marketed under the Superspher® tradename in Europe.

LiChrospher Phases

LiChrospher Phase	Functional Group	Endcapped	Particle Size ^{1,2} (µm)	Pore Size (Å)	Surface Area (m ² /g)	Carbon Load (%)
Si 60	-	-	5	60	700	-
Si 100	-	-	5	100	400	-
100RP-8	Octyl	No	5	100	350	12.5
100RP-8e	Octyl	Yes	5	100	350	13.0
100RP-18	Octadecyl	No	5	100	350	21.0
100RP-18e	Octadecyl	Yes	5	100	350	21.6
100NH ₂	Amino	No	5	100	350	4.6
100CN	Cyano	No	5	100	350	6.6
100DIOL	Hydroxyl	No	5	100	350	8.0
60RP-select B	Octyl	Yes	5	60	360	11.5

¹ Superspher 4µm columns available

² LiChrospher 10µm particle size materials available

Superspher Phases

Superspher Phase ¹	Functional Group	Endcapped	Particle Size (µm)	Pore Size (Å)	Surface Area (m ² /g)	Carbon Load (%)
Si 60	-	-	4	60	700	-
60RP-8	Octyl	No	4	60	350	12.5
60RP-8e	Octyl	Yes	4	60	350	13.0
100RP-18	Octadecyl	No	4	100	350	21.0
100RP-18e	Octadecyl	Yes	4	100	350	21.6
60RP-select B	Octyl	Yes	4	60	360	11.5

¹ Please contact us for ordering information on Superspher columns

Ordering Information – Hichrom Manufactured LiChrospher Columns

Microbore (1.0mm i.d.) Columns

Please contact Hichrom for further details of 1.0mm i.d. LiChrospher columns.

Microbore (2.1mm i.d.) Columns

LiChrospher Phase	Column Dimensions (mm)					Guard Cartridges ^{1,2} (For 2.1mm i.d. Columns)
	50 x 2.1	100 x 2.1	125 x 2.1	150 x 2.1	250 x 2.1	
5µm						
Si60	LISP60-5-50AM	LISP60-5-100AM	LISP60-5-125AM	LISP60-5-150AM	LISP60-5-250AM	LISP60-5-10CM5
Si100	LISP100-5-50AM	LISP100-5-100AM	LISP100-5-125AM	LISP100-5-150AM	LISP100-5-250AM	LISP100-5-10CM5
100RP-8	LISPRP8-5-50AM	LISPRP8-5-100AM	LISPRP8-5-125AM	LISPRP8-5-150AM	LISPRP8-5-250AM	LISPRP8-5-10CM5
100RP-8e	LISPRP8E-5-50AM	LISPRP8E-5-100AM	LISPRP8E-5-125AM	LISPRP8E-5-150AM	LISPRP8E-5-250AM	LISPRP8E-5-10CM5
100RP-18	LISPRP18-5-50AM	LISPRP18-5-100AM	LISPRP18-5-125AM	LISPRP18-5-150AM	LISPRP18-5-250AM	LISPRP18-5-10CM5
100RP-18e	LISPRP18E-5-50AM	LISPRP18E-5-100AM	LISPRP18E-5-125AM	LISPRP18E-5-150AM	LISPRP18E-5-250AM	LISPRP18E-5-10CM5
100NH ₂	LISPNH-5-50AM	LISPNH-5-100AM	LISPNH-5-125AM	LISPNH-5-150AM	LISPNH-5-250AM	LISPNH-5-10CM5
100CN	LISPCN-5-50AM	LISPCN-5-100AM	LISPCN-5-125AM	LISPCN-5-150AM	LISPCN-5-250AM	LISPCN-5-10CM5
100DIOL	LISPOH-5-50AM	LISPOH-5-100AM	LISPOH-5-125AM	LISPOH-5-150AM	LISPOH-5-250AM	LISPOH-5-10CM5
60RP-select B	LISPRPB-5-50AM	LISPRPB-5-100AM	LISPRPB-5-125AM	LISPRPB-5-150AM	LISPRPB-5-250AM	LISPRPB-5-10CM5

¹ 5/pk – Use with free-standing holder HI-161 and column coupler HI-081 - see p.20

² Starter kits also available - see p.21

Ordering Information – Hichrom Manufactured LiChrospher® Columns (continued)

Medium Bore (3.2mm i.d.) Columns

LiChrospher Phase	Column Dimensions (mm)					Guard Cartridges ^{1,2} (For 3.2mm i.d. Columns)
	50 x 3.2	100 x 3.2	125 x 3.2	150 x 3.2	250 x 3.2	
5µm						
Si60	LISP60-5-50AS	LISP60-5-100AS	LISP60-5-125AS	LISP60-5-150AS	LISP60-5-250AS	LISP60-5-10C5
Si100	LISP100-5-50AS	LISP100-5-100AS	LISP100-5-125AS	LISP100-5-150AS	LISP100-5-250AS	LISP100-5-10C5
100RP-8	LISPRP8-5-50AS	LISPRP8-5-100AS	LISPRP8-5-125AS	LISPRP8-5-150AS	LISPRP8-5-250AS	LISPRP8-5-10C5
100RP-8e	LISPRP8E-5-50AS	LISPRP8E-5-100AS	LISPRP8E-5-125AS	LISPRP8E-5-150AS	LISPRP8E-5-250AS	LISPRP8E-5-10C5
100RP-18	LISPRP18-5-50AS	LISPRP18-5-100AS	LISPRP18-5-125AS	LISPRP18-5-150AS	LISPRP18-5-250AS	LISPRP18-5-10C5
100RP-18e	LISPRP18E-5-50AS	LISPRP18E-5-100AS	LISPRP18E-5-125AS	LISPRP18E-5-150AS	LISPRP18E-5-250AS	LISPRP18E-5-10C5
100NH2	LISPNH-5-50AS	LISPNH-5-100AS	LISPNH-5-125AS	LISPNH-5-150AS	LISPNH-5-250AS	LISPNH-5-10C5
100CN	LISPCN-5-50AS	LISPCN-5-100AS	LISPCN-5-125AS	LISPCN-5-150AS	LISPCN-5-250AS	LISPCN-5-10C5
100DIOL	LISPOH-5-50AS	LISPOH-5-100AS	LISPOH-5-125AS	LISPOH-5-150AS	LISPOH-5-250AS	LISPOH-5-10C5
60RP-select B	LISPRPB-5-50AS	LISPRPB-5-100AS	LISPRPB-5-125AS	LISPRPB-5-150AS	LISPRPB-5-250AS	LISPRPB-5-10C5

Analytical (4.0mm i.d.) Columns

LiChrospher Phase	Column Dimensions (mm)					Guard Cartridges ^{1,2} (For 4.0mm i.d. Columns)
	50 x 4.0	100 x 4.0	125 x 4.0	150 x 4.0	250 x 4.0	
5µm						
Si60	LISP60-5-50AF	LISP60-5-100AF	LISP60-5-125AF	LISP60-5-150AF	LISP60-5-250AF	LISP60-5-10C5
Si100	LISP100-5-50AF	LISP100-5-100AF	LISP100-5-125AF	LISP100-5-150AF	LISP100-5-250AF	LISP100-5-10C5
100RP-8	LISPRP8-5-50AF	LISPRP8-5-100AF	LISPRP8-5-125AF	LISPRP8-5-150AF	LISPRP8-5-250AF	LISPRP8-5-10C5
100RP-8e	LISPRP8E-5-50AF	LISPRP8E-5-100AF	LISPRP8E-5-125AF	LISPRP8E-5-150AF	LISPRP8E-5-250AF	LISPRP8E-5-10C5
100RP-18	LISPRP18-5-50AF	LISPRP18-5-100AF	LISPRP18-5-125AF	LISPRP18-5-150AF	LISPRP18-5-250AF	LISPRP18-5-10C5
100RP-18e	LISPRP18E-5-50AF	LISPRP18E-5-100AF	LISPRP18E-5-125AF	LISPRP18E-5-150AF	LISPRP18E-5-250AF	LISPRP18E-5-10C5
100NH2	LISPNH-5-50AF	LISPNH-5-100AF	LISPNH-5-125AF	LISPNH-5-150AF	LISPNH-5-250AF	LISPNH-5-10C5
100CN	LISPCN-5-50AF	LISPCN-5-100AF	LISPCN-5-125AF	LISPCN-5-150AF	LISPCN-5-250AF	LISPCN-5-10C5
100DIOL	LISPOH-5-50AF	LISPOH-5-100AF	LISPOH-5-125AF	LISPOH-5-150AF	LISPOH-5-250AF	LISPOH-5-10C5
60RP-select B	LISPRPB-5-50AF	LISPRPB-5-100AF	LISPRPB-5-125AF	LISPRPB-5-150AF	LISPRPB-5-250AF	LISPRPB-5-10C5

Analytical (4.6mm i.d.) Columns

LiChrospher Phase	Column Dimensions (mm)					Guard Cartridges ^{1,2} (For 4.6mm i.d. Columns)
	50 x 4.6	100 x 4.6	125 x 4.6	150 x 4.6	250 x 4.6	
5µm						
Si60	LISP60-5-50A	LISP60-5-100A	LISP60-5-125A	LISP60-5-150A	LISP60-5-250A	LISP60-5-10C5
Si100	LISP100-5-50A	LISP100-5-100A	LISP100-5-125A	LISP100-5-150A	LISP100-5-250A	LISP100-5-10C5
100RP-8	LISPRP8-5-50A	LISPRP8-5-100A	LISPRP8-5-125A	LISPRP8-5-150A	LISPRP8-5-250A	LISPRP8-5-10C5
100RP-8e	LISPRP8E-5-50A	LISPRP8E-5-100A	LISPRP8E-5-125A	LISPRP8E-5-150A	LISPRP8E-5-250A	LISPRP8E-5-10C5
100RP-18	LISPRP18-5-50A	LISPRP18-5-100A	LISPRP18-5-125A	LISPRP18-5-150A	LISPRP18-5-250A	LISPRP18-5-10C5
100RP-18e	LISPRP18E-5-50A	LISPRP18E-5-100A	LISPRP18E-5-125A	LISPRP18E-5-150A	LISPRP18E-5-250A	LISPRP18E-5-10C5
100NH2	LISPNH-5-50A	LISPNH-5-100A	LISPNH-5-125A	LISPNH-5-150A	LISPNH-5-250A	LISPNH-5-10C5
100CN	LISPCN-5-50A	LISPCN-5-100A	LISPCN-5-125A	LISPCN-5-150A	LISPCN-5-250A	LISPCN-5-10C5
100DIOL	LISPOH-5-50A	LISPOH-5-100A	LISPOH-5-125A	LISPOH-5-150A	LISPOH-5-250A	LISPOH-5-10C5
60RP-select B	LISPRPB-5-50A	LISPRPB-5-100A	LISPRPB-5-125A	LISPRPB-5-150A	LISPRPB-5-250A	LISPRPB-5-10C5

¹ 5/pk – Use with free-standing holder HI-161 and column coupler HI-081 - see p.20² Starter kits also available - see p.21

Semi-Preparative and Preparative (7.75 - 21.2mm i.d.) Columns

Please contact Hichrom for further details of 7.75 - 21.2mm i.d. LiChrospher columns.

LiChrorep®

- Irregular preparative silica
- Three particle size ranges
- Guaranteed reproducibility from analytical (LiChrosorb and LiChrospher) to preparative phases
- Competitive price

LiChrorep® is a proven, highly successful packing material providing fast, effective and reproducible separations in HPLC and medium pressure chromatography. Merck offer three different particle size ranges of LiChrorep silica, available as a base silica or C18 bonded phase. The smaller particle size range, 15-25µm, is the most suitable for HPLC. LiChrorep RP-8, amino-, cyano- and diol-bonded phases are available in larger particle size materials.

Preparative Scale-Up

Figure 1A shows an analytical scouting separation of a prostaglandin sample performed at 1.5ml/min on a 10µm 250 x 4mm LiChrosorb Si60 column. A scaled up separation of the same prostaglandin sample (Figure 1B), but with higher loading, was performed at 2.0litre/min on a 600 x 200mm LiChrorep Si60 column packed with 25-40µm particles. In this example, four different fractionation zones were identified from which the prostaglandin purity was identified.

The lack of silanol groups means that endcapping is not required. In addition, unlike conventional silica (Si-OH) columns, TYPE-C (Si-H) columns do not suffer from column phase bleed (eg. Phenyl Hydride is more stable than a conventional silica phenyl phase).

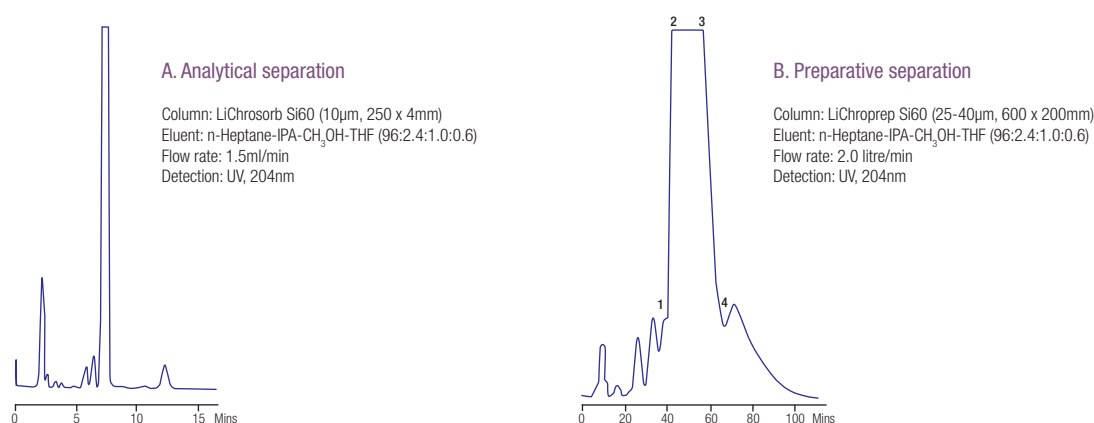
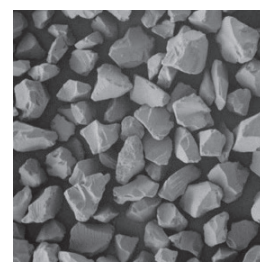

Figure 1. Example of preparative scale-up

LiChrorep RP-18 Phase

Particle Size Range (µm)	15-25	25-40	40-63
Mean Particle Size (µm)	22	32	54
Minimum Theoretical Plates (plates/m) ¹	10,000	5,500	1500
Typical Column Back Pressure (psi) ¹	150	90	75
Surface Area (m ² /g)		320	
Pore Size (Å)		100	
Carbon Load (%)		17-19	



¹ 250 x 4 mm, CH₃CN-H₂O (75:25) @ 1ml/min.

Ordering Information

LiChrorep Phase	Particle Size (µm)	Bulk Material ¹			
		100g	250g	500g	1kg
Si 60	15-25	-	-	-	09336.1000
	25-40	-	-	-	09390.1000
	40-63	-	13905.0250	-	13905.1000
RP-18	15-25	-	-	13901.0500	-
	25-40	09303.0100	-	09303.0500	-
	40-63	-	13900.0250	-	13900.1000
RP-8	40-63	-	09362.0250	-	09362.1000
DIOL	40-63	-	13973.0250	-	-
NH2	40-63	-	13974.0250	-	13974.1000
CN	40-63	-	13959.0250	-	-

¹ Larger pack sizes also available

- Si-OH bonds replaced by Si-H bonds
- Highly stable, low bleed columns
- Fast re-equilibration for fast cycle time
- Increased retention of polar compounds
- Operable in RP, NP and ANP modes

MicroSolv Technology Corporation, USA manufacture the Cogent™ TYPE-C™ silica phases. They are formed from a high purity Type B silica backbone which is modified to cover the silica surface with silicon-hydride (Si-H) bonds, thus replacing >95% of surface silanols (Si-OH), as indicated in Figure 1. Using patented technology, bonded phases such as C18, C8, Phenyl, Cholesterol and Diamond Hydride are produced from the unique silica hydride surface with direct silicon-carbon bonds (see Figure 8 on page 117). These extremely strong bonds offer increased stability over traditional silica based phases.

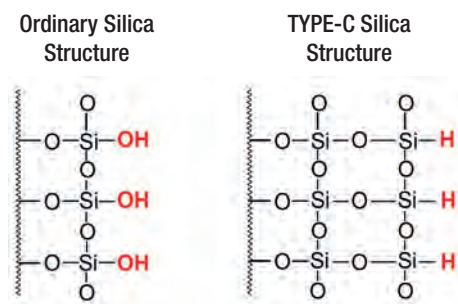

Figure 1. TYPE-C silica surface

The lack of silanol groups means that endcapping is not required. In addition, unlike conventional silica (Si-OH) columns, TYPE-C (Si-H) columns do not suffer from column phase bleed (eg. Phenyl Hydride is more stable than a conventional silica phenyl phase).

Cogent™ Phases¹

Cogent Phase	Particle Size ² (µm)	Pore Size (Å)	Surface Area (m ² /g)	Carbon Load (%)	Endcapped	pH Range	Max. Temp. (°C)
Silica-C	4	100	350	-	-	1 - 7	60
Bidentate C18	4	100	350	16.5	No	1 - 10	80
Bidentate C8	4	100	350	7	No	1 - 8	80
Phenyl Hydride	4	100	350	10.8	No	1 - 8	80
UDC-Cholesterol	4	100	350	12	No	1 - 8	80
Diamond Hydride	4	100	350	> 0.5	-	2.5 - 7	60
Bidentate C8 300	5	300	150	5	No	1 - 8	80

¹ UDA and Diol phases also available - please see pages 2 and 4

² 2.2µm phases also available - see page 116

The surface silanols that are present in all Type A and B silicas, even after bonding and extensive endcapping, form a strong association with water resulting in a 'hydration shell' surrounding the silica (see Figure 2). However, the silica hydride particles of TYPE-C silica are slightly hydrophobic and have only a weak attraction for water. TYPE-C columns can be operated in 3 modes of chromatography: reversed-phase, normal-phase and aqueous normal-phase. Unlike HILIC, aqueous normal-phase (ANP) does not require a 'water-rich' environment in order to operate.

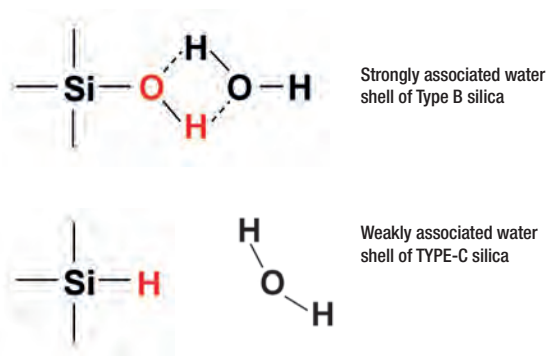

Figure 2. Type B vs TYPE-C silica

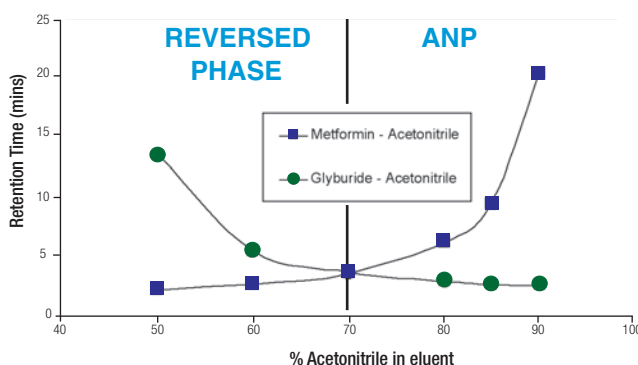

Figure 3. Dual RP and ANP retention capability

Aqueous Normal-Phase (ANP)

Cogent TYPE-C silica based phases (Bidentate C18, Bidentate C8, UDC-Cholesterol, Diamond Hydride, Phenyl Hydride, UDA and Silica-C) have the ability to operate in ANP mode which enables the retention of polar solutes at high concentrations of the organic component whilst maintaining an aqueous component in the eluent. The exact point in the composition of the eluent where ANP retention begins depends on the solute as well as the stationary phase. In addition, TYPE-C columns can also retain non-polar compounds based on a typical reversed-phase mechanism. Figure 3 illustrates the dual retention capability for both polar (metformin) and non-polar (glyburide) compounds. In this case, with an eluent composition of less than 70% acetonitrile, glyburide and metformin are both retained by a reversed-phase mechanism, with the metformin eluting first. With increasing percentages of acetonitrile, the retention of metformin increases significantly due to ANP mechanisms and now elutes after glyburide (see Figure 9 on page 117).

Cogent Diamond Hydride™ (The ‘Metabolomics’ Column)

- Excellent peak shape
- Useful for high polarity compounds
- Retain amino acids without derivatisation
- Excellent choice for metabolomics

Cogent Diamond Hydride™, containing a low level of carbon on the surface, is a unique phase for the analysis of extremely polar compounds by aqueous normal-phase (see page 115). It is a popular choice for the analysis of metabolites, underivatized amino acids, carbohydrates and small organic acids. Figure 4 shows the separation of sarcosine, a potential urine biomarker, from isobaric β-alanine on a Cogent Diamond Hydride LC-MS column. Figure 5 shows the separation of four nucleotide bases on Cogent Diamond Hydride under 100% aqueous conditions.

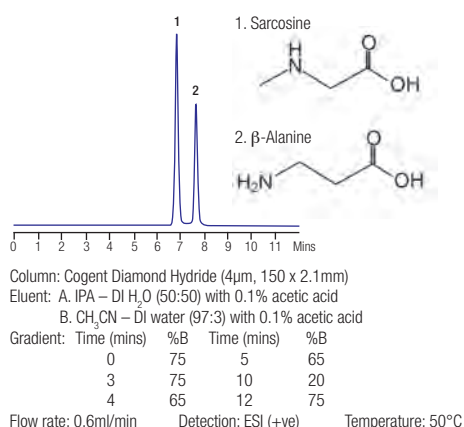

Figure 4. Separation of sarcosine and β-alanine

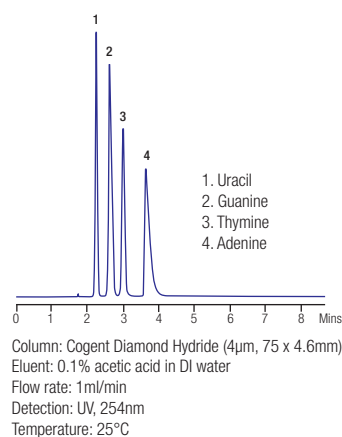

Figure 5. Separation of nucleotide bases

Figure 6 shows the separation of metabolites in human urine and Figure 7 shows the analysis of sumatriptan tablets using Cogent Diamond Hydride columns.

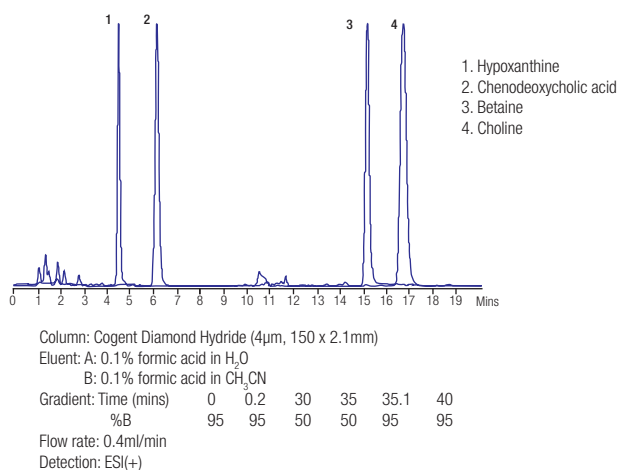

Figure 6. Analysis of metabolites in human urine

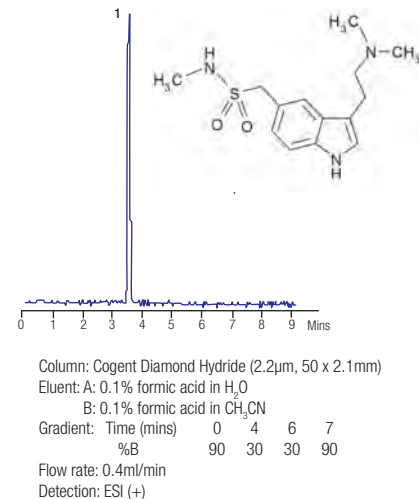

Figure 7. Analysis of sumatriptan tablets

Metabolomics Kits

Metabolomics kits are ideal for LC-MS when searching for very polar and very hydrophobic compounds from serum, plasma, urine, saliva or any other biological fluid. They consist of one Cogent Diamond Hydride and one Cogent Bidentate C18 column of the same dimensions. Using both aqueous normal-phase and reversed-phase with these two columns, both positive and negative species can be separated and very accurate ‘metabolomes’ can be produced. Please enquire for further details.

Cogent 2.0™ HPLC Columns

Cogent 2.0 silica hydride columns have a particle size of 2.2µm and show increased efficiencies compared to the 4µm phases. They have an upper pressure limit of 9,500 psi. The part numbers for Cogent Diamond Hydride and Bidentate C18 2.0 HPLC columns are shown on page 120. Please enquire for the availability of alternative dimensions and further phases.

Please see page 120 for ordering information.

Cogent Bidentate C18™

- Use in RP, NP and ANP modes
- Robust and reliable
- Useful up to pH 10

The C18 in Cogent Bidentate C18™ is bonded directly to the TYPE-C™ silica surface with two separate points of attachment (Figure 8). Columns are highly durable and suitable for use with 100% water or 100% organic solvent. These columns will retain the most polar compounds with $\geq 70\%$ organic content. Figure 9 shows the separation of polar metformin and non-polar glyburide by aqueous normal-phase (see page 115) and reversed-phase methods.

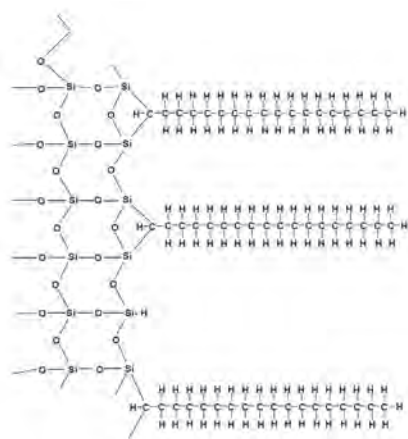

Figure 8. Bonding in Cogent Bidentate C18

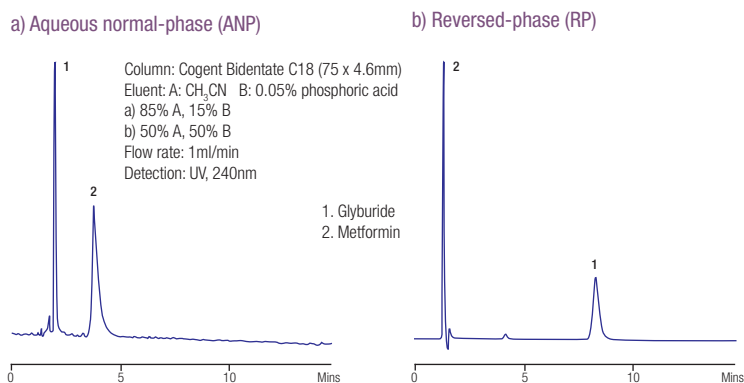
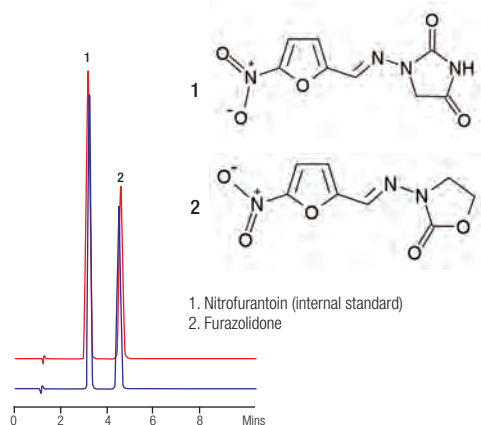

Figure 9. Separation of polar and non-polar compounds

Cogent Bidentate C8™

- Good starter column for ANP
- Polar and non-polar analytes
- Useful for complex mixtures

As with Cogent Bidentate C18, the Cogent Bidentate C8™ phase is bonded directly to the TYPE-C silica surface with two separate points of attachment. Columns are stable and efficient and can operate in RP, NP and ANP modes. Figure 10 shows the separation of furazolidone and nitrofurantoin. Figure 11 shows the separation of sulfisoxazole acetyl from the preservatives methyl paraben and propyl paraben. A 300Å phase, as well as the 100Å phase, is available.



Column: Cogent Bidentate C8 (4µm, 75 x 4.6mm)
 Eluent: H₂O – CH₃CN (80:20) with 0.1% formic acid
 Flow rate: 1ml/min
 Detection: UV, 367nm

Figure 10. Analysis of furazolidone on Cogent Bidentate C8

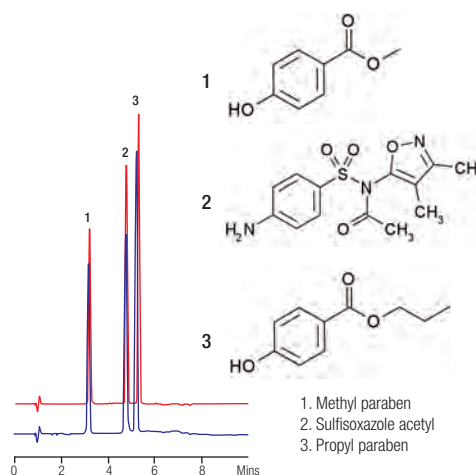

Column: Cogent Bidentate C8 (4µm, 75 x 4.6mm)
 Eluent: A: 0.1% TFA in H₂O
 B: 0.1% TFA in CH₃CN
 Gradient: Time (mins) 0 1 6 7
 %B 30 30 60 30
 Flow rate: 1ml/min
 Detection: UV, 254nm

Figure 11. Analysis of sulfisoxazole acetyl

Please see page 120 for ordering information.

Cogent Phenyl Hydride™

- Good selectivity for aromatic compounds
- Use in RP or ANP modes
- Long column lifetime

Cogent Phenyl Hydride™ columns, based on TYPE-C silica, are an ideal choice for difficult to separate aromatic compounds. Due to the lack of endcapping, these columns do not exhibit 'bleed', making them ideal for LC-MS analyses. Direct silicon-carbon bonds and the hydride surface enable long column lifetimes to be achieved. Figure 12 shows the separation of levothyroxine and liothyronine on a Cogent Phenyl Hydride column.

Figure 13 shows the separation of the cis and trans isomers of the antibiotic cefprozil.

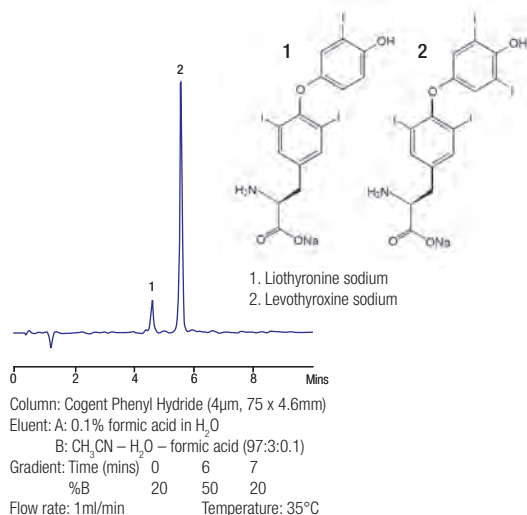

Figure 12. Analysis of levothyroxine

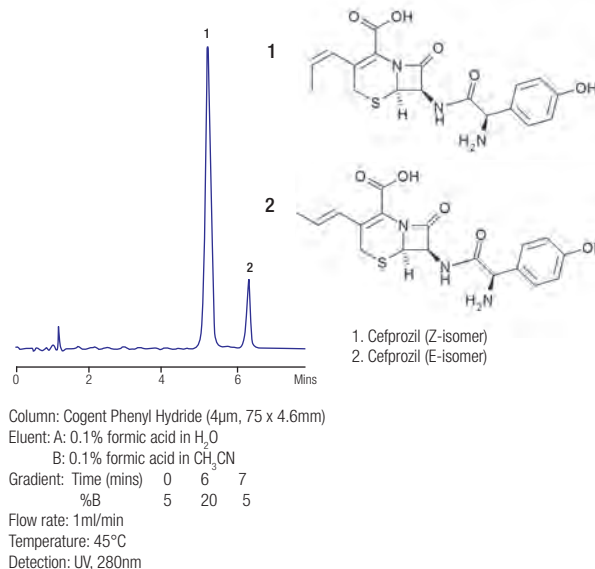

Figure 13. Separation of cefprozil isomers

Cogent UDC-Cholesterol™

- Operable in RP, NP and ANP modes
- Good shape recognition (eg. for steroids)
- Unique selectivity
- Medium range of hydrophobicity

The Cogent UDC-Cholesterol™ stationary phase is a liquid crystal attached to a silica-hydride particle and produces unique selectivity for many compounds, especially at lower temperatures. Figure 14 shows that Cogent UDC-Cholesterol with acetonitrile as organic modifier produced similar results for the separation of the steroids ethinyl estradiol and norgestrel at the three different temperatures shown, with negligible effect on selectivity and retention. However, using methanol as modifier relative retention times differ considerably and elution order is reversed. This indicates that when used with methanol, Cogent UDC-Cholesterol has a selectivity mechanism based on shape recognition.

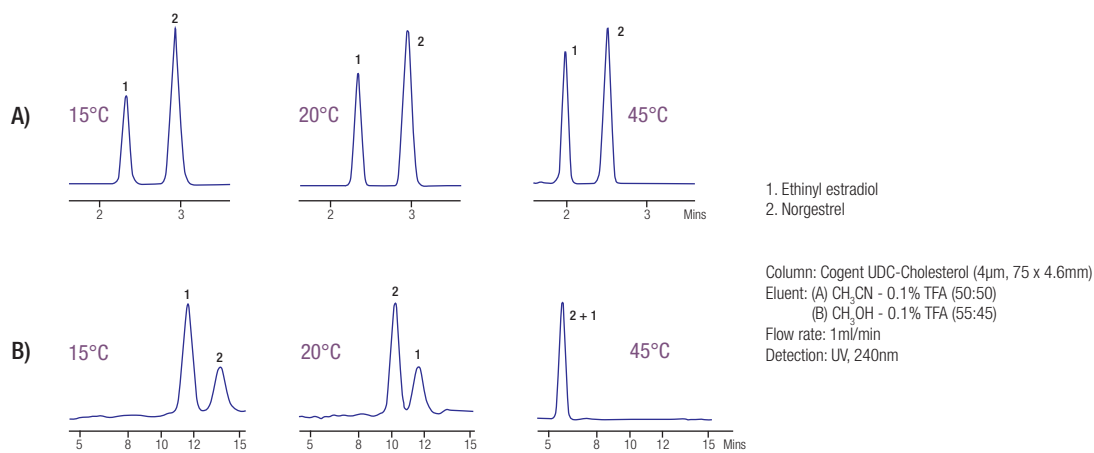

Figure 14. Molecular shape recognition of Cogent UDC-Cholesterol

Please see page 120 for ordering information.

Cogent Silica-C™

- Useful for highly polar compounds
- Very rugged and reproducible
- Suitable for NP and ANP applications

For the retention of very polar compounds, Cogent Silica-C™ is the best choice from the TYPE-C™ suite of columns. Since this unbonded phase has virtually no silanols, it does not have a strong association with water and other solvents and will not have the expected hydration shell of other silica based columns. Cogent Silica-C is suitable for NP and ANP applications and for preparative chromatography. Figure 15 shows the separation of underivatized L-(+)-alpha-phenylglycine and L-phenylalanine under LC-MS conditions.



Figure 15. Separation of aromatic amino acids

Other Cogent (High Purity Type B) Columns

In addition to their unique TYPE-C silica phases, MicroSolv also manufacture a range of phases based on 'conventional' Type B silica. These phases include C18, C8, Amino, Phenyl, Cyano, Silica, UPHOLD C27 and C30. The specifications of the longer chain phases are shown below.

Longer Chain Hydrophobic Columns

Cogent Phase	Particle Size (μ m)	Pore Size (\AA)	Surface Area (m^2/g)	Carbon Load (%)	Endcapped	pH Range	Max. Temp. ($^{\circ}\text{C}$)
C30	3, 5	200	n/a	18	No	2 - 8	40
UPHOLD C27	5	120	300	17	Yes	2 - 8	60

Cogent C30 shows good selectivity characteristics for the separation of complex carotenoid mixtures. The longer C30 ligands show enhanced interactions with lipophilic long chain carotenoid compounds. In addition to reversed-phase interactions, geometrical and positional isomers of the conjugated double bond systems can be differentiated by analyte shape. At lower temperatures, the long alkyl chains become more rigid and steric effects become significant, leading to greater selectivity. This is illustrated in Figure 16 for a complex carotenoid mixture. Cogent C30 columns are also suitable for the analysis of peptides and some proteins.

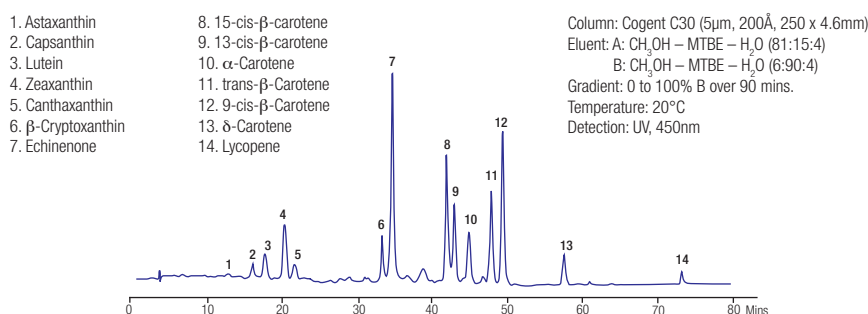

Figure 16. Separation of carotenoids

Please contact us for ordering information on all Cogent Type B columns.

Ordering Information – Cogent TYPE-C™ Silica Analytical Columns

Cogent Phase 4µm	Column Dimensions (mm)					Guard Columns ^{1,2} (20 x 2mm, 5/pk)
	50 x 2.1	75 x 2.1	100 x 2.1	150 x 2.1	250 x 2.1	
Silica-C	40000-05P-2	40000-7.5P-2	40000-10P-2	40000-15P-2	40000-25P-2	40000-GC2
Bidentate C18	40018-05P-2	40018-75P-2	40018-10P-2	40018-15P-2	40018-25P-2	40018-GC2
Bidentate C8	40008-05P-2	40008-75P-2	40008-10P-2	40008-15P-2	40008-25P-2	40008-GC2
Phenyl Hydride	69020-05P-2	-	69020-10P-2	69020-15P-2	69020-25P-2	69020-GC1
UDC-Cholesterol	69069-05P-2	69069-7.5P-2	69069-10P-2	69069-15P-2	69069-25P-2	69069-GC2
Diamond Hydride	70000-05P-2	70000-7.5P-2	70000-10P-2	70000-15P-2	70000-25P-2	70000-GC1
Bidentate C8 300	40008-05P-2-3M	40008-75P-2-3M	40008-10P-2-3M	40008-15P-2-3M	40008-25P-2-3M	-

Cogent Phase 4µm	Column Dimensions (mm)					Guard Columns ^{1,2} (20 x 2mm, 5/pk)
	50 x 3.0	75 x 3.0	100 x 3.0	150 x 3.0	250 x 3.0	
Silica-C	40000-05P-3	-	40000-10P-3	40000-15P-3	-	40000-GC2
Bidentate C18	40018-05P-3	-	40018-10P-3	40018-15P-3	-	40018-GC2
Bidentate C8	40008-05P-3	-	40008-10P-3	40008-15P-3	-	40008-GC2
Phenyl Hydride	69020-05P-3	-	69020-10P-3	69020-15P-3	69020-25P-3	69020-GC1
UDC-Cholesterol	69069-05P-3	-	69069-10P-3	69069-15P-3	69069-25P-3	69069-GC2
Diamond Hydride	70000-05P-3	-	70000-10P-3	70000-15P-3	70000-25P-3	70000-GC1
Bidentate C8 300	-	-	-	-	-	-

Cogent Phase 4µm	Column Dimensions (mm)					Guard Columns ^{1,2} (20 x 4mm, 5/pk)
	50 x 4.6	75 x 4.6	100 x 4.6	150 x 4.6	250 x 4.6	
Silica-C	40000-05P	40000-7.5P	40000-10P	40000-15P	40000-25P	40000-GC3
Bidentate C18	40018-05P	40018-75P	40018-10P	40018-15P	40018-25P	40018-GC3
Bidentate C8	40008-05P	40008-75P	40008-10P	40008-15P	40008-25P	40008-GC3
Phenyl Hydride	69020-05P	69020-75P	69020-10P	69020-15P	69020-25P	69020-GC2
UDC-Cholesterol	69069-05P	69069-7.5P	69069-10P	69069-15P	69069-25P	69069-GC3
Diamond Hydride	70000-05P	70000-7.5P	70000-10P	70000-15P	70000-25P	70000-GC2
Bidentate C8 300	-	40008-75P-3M	40008-10P-3M	40008-15P-3M	40008-25P-3M	-

¹ Requires universal guard holder 81000-GD² 1mm guards also available. Alternative holder required

High Throughput Columns

Cogent Phase 4µm	Column Dimensions (mm)	
	20 x 2.1	30 x 2.1
Diamond Hydride	70000-02P-2	70000-03P-2
Phenyl Hydride	69020-02P-2	69020-03P-2

Semi-preparative and Preparative Columns

Cogent Phase 4µm	Column Dimensions (mm)					
	100 x 10.0	150 x 10.0	250 x 10.0	100 x 21.2	150 x 21.2	250 x 21.2
Silica-C	-	40000-SP150	-	40000-P21-100	40000-P21-150	40000-P21-250
Bidentate C18	40018-SP100	40018-SP150	40018-SP250	40018-P21-100	40018-P21-150	40018-P21-250
Bidentate C8	40008-SP100	40008-SP150	40008-SP250	40008-P21-100	40008-P21-150	40008-P21-250
UDC-Cholesterol	69069-SP100	69069-SP150	-	69069-P21-100	69069-P21-150	69069-P21-250
Diamond Hydride	70000-SP100	70000-SP150	70000-SP250	70000-P21-100	70000-P21-150	70000-P21-250

Cogent 2.5 Phase Columns

Cogent 2.5 Phase	Column Dimensions ¹ (mm)					
	20 x 2.1	30 x 2.1	50 x 2.1	75 x 2.1	100 x 2.1	150 x 2.1
Silica-C	40200-02P-2	40200-03P-2	40200-05P-2	40200-75P-2	40200-10P-2	40200-15P-2
Bidentate C18	40218-02P-2	40218-03P-2	40218-05P-2	40218-75P-2	40218-10P-2	40218-15P-2
Diamond Hydride	70200-02P-2	70200-03P-2	70200-05P-2	70200-75P-2	70200-10P-2	70200-15P-2

¹ Other column dimensions available – please enquire

- Acquired by Hichrom from Whatman, a division of GE Healthcare, in 2012
- Choice of spherical or irregular silica
- Wide range of surface chemistries

Partisil® and Partisphere® Acquisition

Hichrom acquired the Partisil and Partisphere HPLC column range from Whatman, a division of GE Healthcare, in 2012. Hichrom worked closely with GE Healthcare during the manufacture of these products for a number of years prior to acquisition and, as such, manufacturing protocols, product specifications and part numbers remain unaffected. All column dimensions previously offered by Whatman/GE Healthcare remain available and are detailed on the following pages.

Hichrom Partisil Columns – Non Standard Whatman/GE Healthcare Dimensions

Hichrom have a deserved reputation for the ability to manufacture and supply high efficiency columns packed into non standard dimensions not originally offered by the silica manufacturer. Partisil columns are no exception, as for many years Hichrom have manufactured Partisil columns into a wider range of column dimensions than available from Whatman/GE Healthcare. These additional dimensions will continue to be supported following the acquisition and are detailed on pages 124-125.

Partisil Phases

- Irregular porous silica
- 5 and 10µm particle sizes
- Hichrom high efficiency

Partisil was one of the first commercially available irregular silicas. A large surface area gives it a high loading capacity. Partisil ion-exchange materials are widely referenced and remain one of the most popular choices for analysts. Partisil 10 ODS3 is similar to Waters µBondapak.

Partisil Phases

Partisil Phase	Functional Group	Particle Size (µm)
Silica	-	5, 10
C8	Octyl	5, 10
ODS	Octadecyl	10
ODS2	Octadecyl	10
ODS3	Octadecyl	5, 10
PAC	Amino-cyano	5, 10
SAX	Tetramethyl ammonium	5, 10
SCX	Sulphonic acid	5, 10

Partisil ODS is a low carbon load C18 phase, with intentionally unbonded surface silanols adding to the selectivity.

Partisil ODS2 is a high carbon load C18 bonded silica phase which makes it the most non-polar and, therefore, the most retentive of the Partisil reversed-phase columns. The high sample load capacity is suitable for preparative work.

Partisil ODS3 is an intermediate carbon load C18 phase used for pharmaceutical, natural products, food, biological and environmental pollutants applications. Partisil 10 ODS3 is similar to Waters µBondapak.

Partisil C8 is recommended for ion-pair chromatography.

Partisil PAC is a Polar Amino Cyano bonded phase with secondary amine groups for good thermal and chemical stability. Fast equilibration enables multiple separation mechanisms, including adsorption, reversed-phase and weak anion-exchange, to be used. The phase is particularly suitable for carbohydrate separations.

Partisil SAX is a strong anion-exchange phase based on quaternary ammonium groups. It is stable over the pH range 1.5 to 7.5. At intermediate pH, use of a Solvecon eluent conditioning column (see part number 4250-001) is recommended to further enhance column lifetime. Typical applications include nucleic acids, organic acids and inorganic anions.

Partisil SCX is a strong cation-exchange phase based on benzenesulphonic acid groups and is stable over the pH range 1.5 to 7.0. At intermediate pH, use of a Solvecon eluent conditioning column (see part number 4251-001) is recommended to further enhance column lifetime. Suitable applications include nucleosides, amino acids, polyamines, drugs and other cationic species.

See page 122 for ordering information for Partisil columns in WCS hardware and dimensions previously offered by Whatman/GE Healthcare. See pages 124-125 for Hichrom Partisil columns in a wider range of dimensions.

Partisphere® Phases

- Spherical 5µm porous silica
- Unique void sealing cartridge hardware
- Convenient and easy to use – hand tightened fittings
- Increased column lifetime

Partisphere® was one of the first commercially available spherical silicas and continues to provide reproducible, high efficiency separations. Partisphere columns are available in a wide range of surface chemistries, including two application specific phases: TAC-1 (Taxane Analysis Column) for the analysis of paclitaxel and other taxanes, and WAX (MAX-1) for corn and soy protein.

Partisphere Phases

Partisphere Phase	Functional Group	Particle Size (µm)
Silica	-	5
C8	Octyl	5
C18	Octadecyl	5
PAC	Amino-cyano	5
SAX	Quaternary ammonium	5
SCX	Sulphonic acid	5
TAC-1 (PFP)	Pentafluorophenyl	5
WAX (MAX-1)	Proprietary	5

Unique Void-sealing Cartridge System

Partisphere columns are available in a unique void sealing (WVS) hardware. If a void eventually forms at the top of the column bed, a simple hand tightening of the inlet fitting moves the frit assembly downwards and recompresses the packed bed, thus removing the void and restoring column efficiency. Large knurled end fittings allow ready hand tightening of the system. All WVS cartridge columns are shipped without end fittings and require end fitting kit, catalogue no. 4631-1001. This item can be interchanged with additional WVS columns.

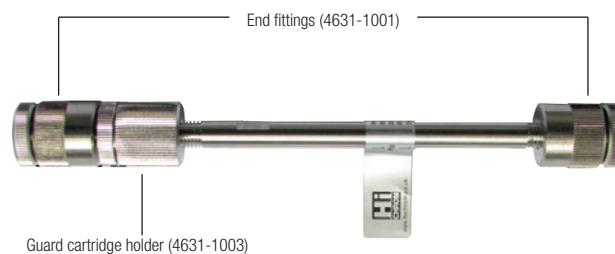

Figure 1. Partisphere WVS hardware cartridge system

Partisphere Guard Cartridge System

Additional installation of the unique WVS guard cartridge holder (catalogue no. 4631-1003) allows the use of guard cartridges (see Figure 1).

Ordering Information - Partisil® and Partisphere®

Partisil 5µm Analytical Columns

Catalogue No.	Description
4222-225	Partisil 5µm ODS3 column, 100 x 4.6mm (WCS hardware - RAC-II)
4222-227	Partisil 5µm SAX column, 100 x 4.6mm (WCS hardware - RAC-II)
4222-228	Partisil 5µm SCX column, 100 x 4.6mm (WCS hardware - RAC-II)
4222-232	Partisil 5µm C8 column, 100 x 4.6mm (WCS hardware - RAC-II)
4215-001	Partisil 5µm SIL column, 250 x 4.6mm (WCS hardware)
4235-001	Partisil 5µm PAC column, 250 x 4.6mm (WCS hardware)
4238-001	Partisil 5µm ODS3 column, 250 x 4.6mm (WCS hardware)
4239-001	Partisil 5µm C8 column, 250 x 4.6mm (WCS hardware)

Partisil 10µm Analytical Columns

Catalogue No.	Description
4216-001	Partisil 10µm SIL column, 250 x 4.6mm (WCS hardware)
4223-001	Partisil 10µm ODS column, 250 x 4.6mm (WCS hardware)
4224-001	Partisil 10µm ODS2 column, 250 x 4.6mm (WCS hardware)
4225-001	Partisil 10µm PAC column, 250 x 4.6mm (WCS hardware)
4226-001	Partisil 10µm SAX column, 250 x 4.6mm (WCS hardware)
4227-001	Partisil 10µm SCX column, 250 x 4.6mm (WCS hardware)
4228-001	Partisil 10µm ODS3 column, 250 x 4.6mm (WCS hardware)
4229-001	Partisil 10µm C8 column, 250 x 4.6mm (WCS hardware)
4141-001	Partisil 10µm SCX column (S-P), 250 x 4.6mm (WCS hardware)

Ordering Information - Partisil® and Partisphere® (continued)

Partisil 10µm Semi-Prep Columns

Catalogue No.	Description
4230-120	Partisil 10µm SIL column, 250 x 9.4mm (Magnum-9 hardware)
4230-124	Partisil 10µm ODS2 column, 250 x 9.4mm (Magnum-9 hardware)
4230-125	Partisil 10µm ODS3 column, 250 x 9.4mm (Magnum-9 hardware)
4230-126	Partisil 10µm PAC column, 250 x 9.4mm (Magnum-9 hardware)
4230-220	Partisil 10µm SIL column, 500 x 9.4mm (Magnum-9 hardware)
4230-224	Partisil 10µm ODS2 column, 500 x 9.4mm (Magnum-9 hardware)
4230-225	Partisil 10µm ODS3 column, 500 x 9.4mm (Magnum-9 hardware)
4232-125	Partisil 10µm ODS3 column, 250 x 20mm (Magnum-20 hardware)
4232-220	Partisil 10µm SIL column, 500 x 20mm (Magnum-20 hardware)

Partisphere 5µm Analytical Columns (note: WVS cartridge columns require end fitting kit p/n 4631-1001)

Catalogue No.	Description
4120-001	Partisphere 5µm WAX (MAX-1) column, 250 x 4.6mm (WCS hardware)
4601-1001	Partisphere 5µm TAC-1 (PFP) cartridge column, 265 x 4.6mm (WVS hardware)
4621-0501	Partisphere 5µm SIL cartridge column, 125 x 4.6mm (WVS hardware)
4621-0502	Partisphere 5µm C18 cartridge column, 125 x 4.6mm (WVS hardware)
4621-0503	Partisphere 5µm C8 cartridge column, 125 x 4.6mm (WVS hardware)
4621-0505	Partisphere 5µm SAX cartridge column, 125 x 4.6mm (WVS hardware)
4621-0507	Partisphere 5µm SCX cartridge column, 125 x 4.6mm (WVS hardware)
4621-0508	Partisphere 5µm PAC cartridge column, 125 x 4.6mm (WVS hardware)
4621-1501	Partisphere 5µm SIL cartridge column, 250 x 4.6mm (WVS hardware)
4621-1502	Partisphere 5µm C18 cartridge column, 250 x 4.6mm (WVS hardware)
4621-1505	Partisphere 5µm SAX cartridge column, 250 x 4.6mm (WVS hardware)
4621-1507	Partisphere 5µm SCX cartridge column, 250 x 4.6mm (WVS hardware)
4621-1508	Partisphere 5µm PAC cartridge column, 250 x 4.6mm (WVS hardware)

Partisil Analytical Cartridge Columns (note: WVS cartridge columns require end fitting kit p/n 4631-1001)

Catalogue No.	Description
4681-0502	Partisil 5µm ODS3 cartridge column, 125 x 4.6mm (WVS hardware)
4681-0505	Partisil 5µm SAX cartridge column, 125 x 4.6mm (WVS hardware)
4681-1501	Partisil 5µm SIL cartridge column, 250 x 4.6mm (WVS hardware)
4681-1502	Partisil 5µm ODS3 cartridge column, 250 x 4.6mm (WVS hardware)
4681-1505	Partisil 5µm SAX cartridge column, 250 x 4.6mm (WVS hardware)
4681-1507	Partisil 5µm SCX cartridge column, 250 x 4.6mm (WVS hardware)
4681-1509	Partisil 5µm ODS2 cartridge column, 250 x 4.6mm (WVS hardware)
4682-1502	Partisil 10µm ODS3 cartridge column, 250 x 4.6mm (WVS hardware)
4682-1505	Partisil 10µm SAX cartridge column, 250 x 4.6mm (WVS hardware)
4682-1507	Partisil 10µm SCX cartridge column, 250 x 4.6mm (WVS hardware)

Accessories

Catalogue No.	Description
4250-001	Partisil 10µm SAX column with Solvecon Kit
4251-001	Partisil 10µm SCX column with Solvecon Kit
4631-1001	Wrenchless WVS End Fitting Kit
4631-1003	WVS Guard Cartridge Holder
4631-1004	WCS Guard Cartridge Holder
4641-0001	Silica Guard Cartridge (5 pack)
4641-0002	Reverse Phase Guard Cartridge (5 pack)
4641-0005	Anion Guard Cartridge (5 pack)
4641-0007	Cation Phase Guard Cartridge (5 pack)
4641-0008	PAC Guard Cartridge (5 pack)
HI-050X	PEEK Fingertight Fitting (10 pack) – suitable for connection of all Partisil and Partisphere columns to all 1/16" o.d. tubing types – slip free to 6000psi.

See also pages 124 and 125 for additional Partisil column dimensions and ordering information.

Hichrom Partisil® Columns – Non Standard Whatman/GE Healthcare Dimensions

Hichrom have a deserved reputation for the ability to manufacture and supply high efficiency columns packed into non standard dimensions not originally offered by the silica manufacturer. Partisil® columns are no exception and for many years Hichrom have manufactured Partisil columns into a wider range of column dimensions than was originally available from Whatman/GE Healthcare. These additional dimensions continue to be supported following the acquisition and are detailed below. Please contact Hichrom for any column dimension not listed.



Ordering Information – Partisil Additional Dimensions

Partisil 2.1mm i.d. Columns

Partisil Phase	Column Dimensions (mm)				Guard Cartridges ^{1,2} (For 2.1mm i.d. Columns)
	50 x 2.1	100 x 2.1	150 x 2.1	250 x 2.1	
Partisil 5 SIL	P5-50AM	P5-100AM	P5-150AM	P5-250AM	P5-10CM5
Partisil 5 C8	P5C8-50AM	P5C8-100AM	P5C8-150AM	P5C8-250AM	P5C8-10CM5
Partisil 5 ODS3	P5ODS3-50AM	P5ODS3-100AM	P5ODS3-150AM	P5ODS3-250AM	P5ODS3-10CM5
Partisil 5 PAC	P5PAC-50AM	P5PAC-100AM	P5PAC-150AM	P5PAC-250AM	P5PAC-10CM5
Partisil 5 SAX	P5SAX-50AM	P5SAX-100AM	P5SAX-150AM	P5SAX-250AM	P5SAX-10CM5
Partisil 5 SCX	P5SCX-50AM	P5SCX-100AM	P5SCX-150AM	P5SCX-250AM	P5SCX-10CM5
Partisil 10 SIL	P10-50AM	P10-100AM	P10-150AM	P10-250AM	P10-10CM5
Partisil 10 C8	P10C8-50AM	P10C8-100AM	P10C8-150AM	P10C8-250AM	P10C8-10CM5
Partisil 10 ODS	P10ODS-50AM	P10ODS-100AM	P10ODS-150AM	P10ODS-250AM	P10ODS-10CM5
Partisil 10 ODS2	P10ODS2-50AM	P10ODS2-100AM	P10ODS2-150AM	P10ODS2-250AM	P10ODS2-10CM5
Partisil 10 ODS3	P10ODS3-50AM	P10ODS3-100AM	P10ODS3-150AM	P10ODS3-250AM	P10ODS3-10CM5
Partisil 10 PAC	P10PAC-50AM	P10PAC-100AM	P10PAC-150AM	P10PAC-250AM	P10PAC-10CM5
Partisil 10 SAX	P10SAX-50AM	P10SAX-100AM	P10SAX-150AM	P10SAX-250AM	P10SAX-10CM5
Partisil 10 SCX	P10SCX-50AM	P10SCX-100AM	P10SCX-150AM	P10SCX-250AM	P10SCX-10CM5

¹ Use with holder HI-161 and column coupler HI-081

² 5/pk – Starter kits also available – see p.21

Partisil 3.2mm i.d. Columns

Partisil Phase	Column Dimensions (mm)				Guard Cartridges ^{1,2} (For 3.2-4.6mm i.d. Columns)
	50 x 3.2	100 x 3.2	150 x 3.2	250 x 3.2	
Partisil 5 SIL	P5-50AS	P5-100AS	P5-150AS	P5-250AS	P5-10C5
Partisil 5 C8	P5C8-50AS	P5C8-100AS	P5C8-150AS	P5C8-250AS	P5C8-10C5
Partisil 5 ODS3	P5ODS3-50AS	P5ODS3-100AS	P5ODS3-150AS	P5ODS3-250AS	P5ODS3-10C5
Partisil 5 PAC	P5PAC-50AS	P5PAC-100AS	P5PAC-150AS	P5PAC-250AS	P5PAC-10C5
Partisil 5 SAX	P5SAX-50AS	P5SAX-100AS	P5SAX-150AS	P5SAX-250AS	P5SAX-10C5
Partisil 5 SCX	P5SCX-50AS	P5SCX-100AS	P5SCX-150AS	P5SCX-250AS	P5SCX-10C5
Partisil 10 SIL	P10-50AS	P10-100AS	P10-150AS	P10-250AS	P10-10C5
Partisil 10 C8	P10C8-50AS	P10C8-100AS	P10C8-150AS	P10C8-250AS	P10C8-10C5
Partisil 10 ODS	P10ODS-50AS	P10ODS-100AS	P10ODS-150AS	P10ODS-250AS	P10ODS-10C5
Partisil 10 ODS2	P10ODS2-50AS	P10ODS2-100AS	P10ODS2-150AS	P10ODS2-250AS	P10ODS2-10C5
Partisil 10 ODS3	P10ODS3-50AS	P10ODS3-100AS	P10ODS3-150AS	P10ODS3-250AS	P10ODS3-10C5
Partisil 10 PAC	P10PAC-50AS	P10PAC-100AS	P10PAC-150AS	P10PAC-250AS	P10PAC-10C5
Partisil 10 SAX	P10SAX-50AS	P10SAX-100AS	P10SAX-150AS	P10SAX-250AS	P10SAX-10C5
Partisil 10 SCX	P10SCX-50AS	P10SCX-100AS	P10SCX-150AS	P10SCX-250AS	P10SCX-10C5

¹ Use with holder HI-161 and column coupler HI-081

² 5/pk – Starter kits also available – see p.21

Ordering Information – Partisil® Additional Dimensions (continued)

Partisil 4.0mm i.d. Columns

Partisil Phase	Column Dimensions (mm)				Guard Cartridges ^{1,2} (For 3.2-4.6mm i.d. Columns)
	50 x 4.0	100 x 4.0	150 x 4.0	250 x 4.0	
Partisil 5 SIL	P5-50AF	P5-100AF	P5-150AF	P5-250AF	P5-10C5
Partisil 5 C8	P5C8-50AF	P5C8-100AF	P5C8-150AF	P5C8-250AF	P5C8-10C5
Partisil 5 ODS3	P5ODS3-50AF	P5ODS3-100AF	P5ODS3-150AF	P5ODS3-250AF	P5ODS3-10C5
Partisil 5 PAC	P5PAC-50AF	P5PAC-100AF	P5PAC-150AF	P5PAC-250AF	P5PAC-10C5
Partisil 5 SAX	P5SAX-50AF	P5SAX-100AF	P5SAX-150AF	P5SAX-250AF	P5SAX-10C5
Partisil 5 SCX	P5SCX-50AF	P5SCX-100AF	P5SCX-150AF	P5SCX-250AF	P5SCX-10C5
Partisil 10 SIL	P10-50AF	P10-100AF	P10-150AF	P10-250AF	P10-10C5
Partisil 10 C8	P10C8-50AF	P10C8-100AF	P10C8-150AF	P10C8-250AF	P10C8-10C5
Partisil 10 ODS	P10ODS-50AF	P10ODS-100AF	P10ODS-150AF	P10ODS-250AF	P10ODS-10C5
Partisil 10 ODS2	P10ODS2-50AF	P10ODS2-100AF	P10ODS2-150AF	P10ODS2-250AF	P10ODS2-10C5
Partisil 10 ODS3	P10ODS3-50AF	P10ODS3-100AF	P10ODS3-150AF	P10ODS3-250AF	P10ODS3-10C5
Partisil 10 PAC	P10PAC-50AF	P10PAC-100AF	P10PAC-150AF	P10PAC-250AF	P10PAC-10C5
Partisil 10 SAX	P10SAX-50AF	P10SAX-100AF	P10SAX-150AF	P10SAX-250AF	P10SAX-10C5
Partisil 10 SCX	P10SCX-50AF	P10SCX-100AF	P10SCX-150AF	P10SCX-250AF	P10SCX-10C5

¹ Use with holder HI-161 and column coupler HI-081² 5/pk – Starter kits also available – see p.21

Partisil 4.6mm i.d. Columns

Partisil Phase	Column Dimensions (mm)				Guard Cartridges ^{1,2} (For 3.2-4.6mm i.d. Columns)
	50 x 4.6	100 x 4.6	150 x 4.6	250 x 4.6	
Partisil 5 SIL	P5-50A	P5-100A	P5-150A	P5-250A	P5-10C5
Partisil 5 C8	P5C8-50A	P5C8-100A	P5C8-150A	P5C8-250A	P5C8-10C5
Partisil 5 ODS3	P5ODS3-50A	P5ODS3-100A	P5ODS3-150A	P5ODS3-250A	P5ODS3-10C5
Partisil 5 PAC	P5PAC-50A	P5PAC-100A	P5PAC-150A	P5PAC-250A	P5PAC-10C5
Partisil 5 SAX	P5SAX-50A	P5SAX-100A	P5SAX-150A	P5SAX-250A	P5SAX-10C5
Partisil 5 SCX	P5SCX-50A	P5SCX-100A	P5SCX-150A	P5SCX-250A	P5SCX-10C5
Partisil 10 SIL	P10-50A	P10-100A	P10-150A	P10-250A	P10-10C5
Partisil 10 C8	P10C8-50A	P10C8-100A	P10C8-150A	P10C8-250A	P10C8-10C5
Partisil 10 ODS	P10ODS-50A	P10ODS-100A	P10ODS-150A	P10ODS-250A	P10ODS-10C5
Partisil 10 ODS2	P10ODS2-50A	P10ODS2-100A	P10ODS2-150A	P10ODS2-250A	P10ODS2-10C5
Partisil 10 ODS3	P10ODS3-50A	P10ODS3-100A	P10ODS3-150A	P10ODS3-250A	P10ODS3-10C5
Partisil 10 PAC	P10PAC-50A	P10PAC-100A	P10PAC-150A	P10PAC-250A	P10PAC-10C5
Partisil 10 SAX	P10SAX-50A	P10SAX-100A	P10SAX-150A	P10SAX-250A	P10SAX-10C5
Partisil 10 SCX	P10SCX-50A	P10SCX-100A	P10SCX-150A	P10SCX-250A	P10SCX-10C5

¹ Use with holder HI-161 and column coupler HI-081² 5/pk – Starter kits also available – see p.21

Please also see pages 122 and 123 for alternative Partisil columns.

Please contact Hichrom for ordering information on any column dimension not listed.





Brownlee™ MPLC Cartridge Columns

Perkin Elmer's Brownlee™ MPLC cartridge columns provide a range of options for HPLC. They are available in three lengths (3, 10 and 22cm) and two internal diameters (4.6 and 2.1mm). A specific cartridge holder (3, 10 or 22cm) is required for each cartridge length. The MPLC cartridge system allows direct coupling of an analytical and NewGuard cartridge without introduction of any dead volume (available for 10cm and 22cm cartridge column lengths). Changing cartridges is easy with the fingertight cartridge design which does not require any wrench-tightening of the holder or disconnecting of tubing from the LC system.

Brownlee Spheri- and Aquapore Phases

Phase	Functional Group	Particle Size (µm)	Pore Size (Å)	Surface Area (m ² /g)	Carbon Load (%)	Endcapped
Spheri-RP-8	C8, monofunctional	5, 10	80	180	6	Yes
Spheri-RP-18	C18, monofunctional	5, 10	80	180	11	Yes
Spheri-ODS	C18, polyfunctional	5	80	180	14	Yes
Aquapore Butyl, BU-300	C4	7	300	100	3	Yes
Aquapore Octyl, RP-300	C8	7	300	100	5	Yes
Aquapore ODS, OD-300	C18	7	300	100	10	Yes

MPLC Cartridge Hardware

Description	Part Number
3cm cartridge holder 	0715-0013
10cm cartridge holder 	0715-0014
22cm cartridge holder 	0715-0015
10cm cartridge holder incorporating NewGuard system 	0715-0016
22cm cartridge holder incorporating NewGuard system 	0715-0017

Ordering Information – Brownlee Spheri- and Aquapore Phases

Brownlee Phase	Cartridge Dimensions ¹ (mm)						NewGuard Cartridge ³ 15 x 3.2mm (3/pk)
	30 x 2.1 ²	30 x 4.6 ²	100 x 2.1	100 x 4.6	220 x 2.1	220 x 4.6	
Spheri-5, RP-8	-	0711-0001	0711-0004	0711-0003	0711-0006	0711-0005	-
Spheri-5, RP-18	0711-0014	0711-0013	0711-0016	0711-0015	0711-0018	0711-0017	-
Spheri-5, ODS	0711-0020	0711-0019	0711-0022	0711-0021	0711-0024	0711-0023	-
Spheri-10, RP-8	-	0711-0121	-	0711-0123	-	-	-
Spheri-10, RP-18	-	0711-0115	-	0711-0117	-	0711-0119	-
Aquapore Butyl, BU-300	0711-0062	0711-0061	0711-0064	-	-	-	0711-0088
Aquapore Octyl, RP-300	0711-0056	0711-0055	0711-0058	0711-0057	0711-0060	0711-0059	0711-0090
Aquapore ODS, OD-300	0711-0234	0711-0235	0711-0233	0711-0232	0711-0236	0711-0231	0711-0092
Cartridge holder hardware alone	0715-0013	0715-0013	0715-0014	0715-0014	0715-0015	0715-0015	-
Cartridge holder hardware incorporating integral NewGuard system	-	-	0715-0016	0715-0016	0715-0017	0715-0017	-

¹ Use with appropriate length cartridge holder 0715-0013/0014/0015

² 2/pk

³ Use with appropriate length integral cartridge holder 0715-0016/0017

Please contact us for ordering details on all Perkin Elmer columns not listed

- Spherical silica, 60 - 1500Å pore size
- Polypeptide covalently bound coating
- High recovery for sensitive, labile proteins

PolyLC of Maryland, USA manufactures a range of unique columns for the more challenging HPLC biochemical applications. Their phases are characterised by the attachment of a polypeptide coating to wide pore silica.

PolyLC Phases

PolyLC Phase ¹	Particle Size (µm)	Pore Size (Å)	Functional Group	Chromatography Mode	Applications
PolyHYDROXYETHYL A™	3, 5, 12	60, 100, 200, 300, 500, 1000, 1500	Hydroxyethylaspartamide	1. Hydrophilic Interaction (HILIC) 2. Size Exclusion	Peptides, proteins, carbohydrates, polar small molecules
PolyCAT A™	3, 5, 12	300, 1000, 1500	Aspartic acid	Weak cation-exchange	Proteins with isoelectric point >6.0
PolyWAX LP™	3, 5, 12	100, 300, 1000, 1500	Linear polyethyleneimine	Weak anion-exchange	Proteins with isoelectric points <6.0, nucleic acids and oligonucleotide analogues
PolyGLYCOPLEX™	5, 12	-	-	Hydrophilic Interaction (HILIC)	Complex carbohydrates
PolySULFOETHYL A™	3, 5, 12	200, 300, 1000	Sulphoethylaspartamide	Strong cation-exchange	Peptides
PolyPROPYL A™	3, 5, 12	300, 1000, 1500	Propylaspartamide	Hydrophobic Interaction (HIC)	Proteins and peptides

¹ PolyMETHYL A™ and PolyETHYL A™ materials are also available

PolyHYDROXYETHYL A™

PolyHYDROXYETHYL A™ is a neutral polar material designed specifically for HILIC. Peptides and proteins are typically eluted with a decreasing gradient of acetonitrile or propanol for peptide mapping or multidimensional purification of synthetic and natural peptides. PolyHYDROXYETHYL A is also used for eliminating detergents, lipids and salts from samples and for the HPLC of solutes that are insoluble in aqueous media, such as membrane proteins. Figure 1 shows a typical chromatogram for the isolation of pure pathogenic prion protein from the brain of a sheep with scrapie.

Table 1.
PolyHYDROXYETHYL A - SEC fractionation ranges (Daltons)

Pore Diameter (Å)	Denaturing Eluent (e.g. 50mM formic acid)	Conventional Eluent (phosphate/sulphate buffer)
60	40-600	40-10,000
200	40-1600	200-25,000
300	40-40,000	300-100,000
500	40-150,000	400-300,000
1000	40-1,000,000	1000-2,000,000
1500	40-1,000,000	5000-2,000,000

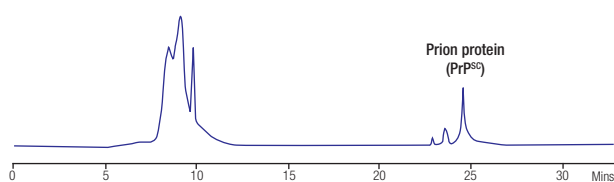

Figure 1. Extract of brain from sheep with scrapie (Proteinase K-treated)

In the absence of organic solvent, PolyHYDROXYETHYL A functions in the SEC mode. Using conventional salt buffers, the fractionation range is determined by the pore size of the packing (see Table 1). However, if the eluent contains a denaturing agent (eg. 50mM formic acid), smaller solutes can be separated by size. The 60Å pore size material permits the separation of peptides and other small solutes by SEC (Figure 2).

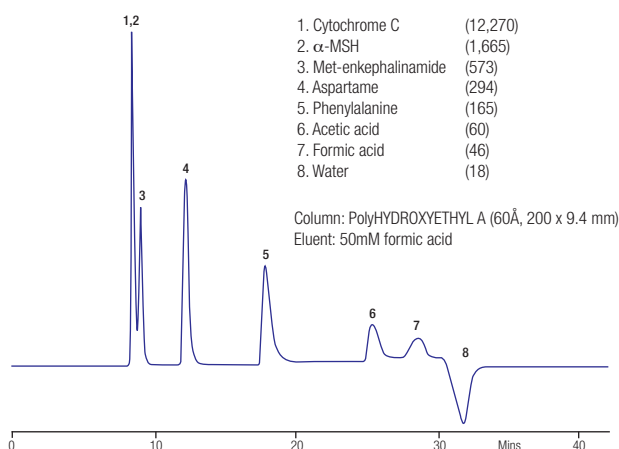
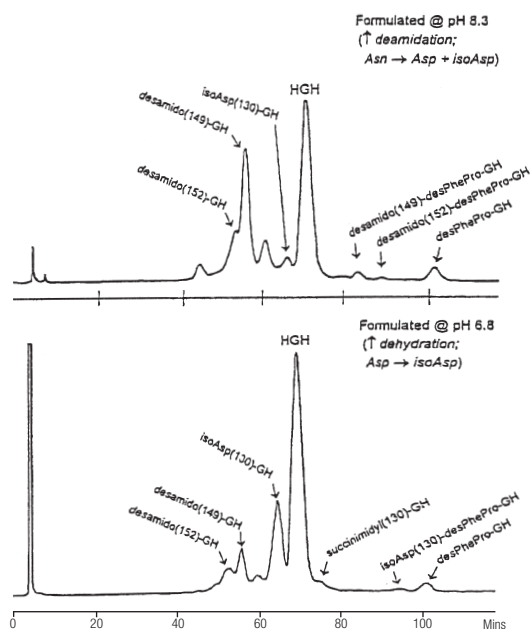

Figure 2. Size exclusion separation of small molecules

PolyCAT A™

PolyCAT A™ consists of poly(aspartic acid) covalently bonded to silica. Proteins elute from the material by weak cation-exchange chromatography, resulting in high efficiency peaks and high binding capacity and recovery. PolyCAT A columns enable the separation and quantitation of many protein variants that differ by a single residue. Side products from the synthesis or degradation on storage of pharmaceutical proteins can effectively be analysed on a PolyCAT A column. Figure 3 shows the analysis of recombinant human growth hormone (HGH) incubated at two different pHs.

PolyCAT A columns are widely used in haemoglobin analyses, where all major and most minor variants are resolved (see Figure 4).



Column: PolyCAT A, 200 x 4.6mm (1000Å)
Eluent: 130-145mM NH₄acetate, pH 4.0 with 40% CH₃CN

Figure 3. Recombinant protein variant analysis
-Human growth hormone after 6 days at 37°C

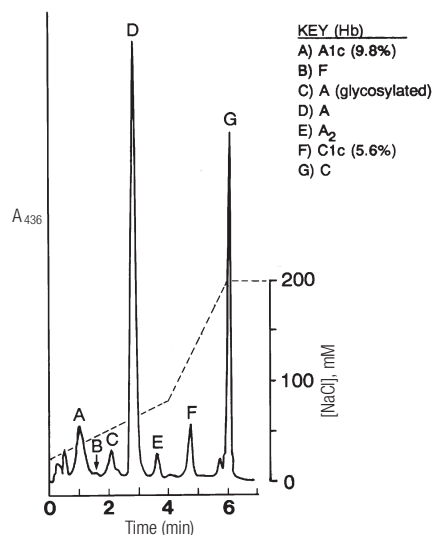

Column: PolyCAT A, 35 x 4.6mm (5µm, 1000Å)
Eluent: Gradient of increasing [NaCl]

Figure 4. Analysis of diabetic haemoglobin (C trait)

PolyWAX LP™

PolyWAX LP™ is a hydrophilic weak anion-exchange (WAX) material prepared with linear polyethyleneimine (PEI), which confers greater selectivity and recovery than conventional branched polymer material. It was developed for the analysis of enzymes and other proteins. PolyWAX LP also offers excellent results for the analysis of larger oligonucleotides, their analogues and dsDNA fragments. The 3µm 1500Å version affords good resolution of oligonucleotides differing by just one base (see Figure 5).

PolyGLYCOPLEX™

PolyGLYCOPLEX™ is a neutral material with a high capacity for retaining complex carbohydrates in the HILIC mode, frequently using just acetonitrile and water. Selectivity is good for both native glycans and derivatives such as those with the 2-aminopyridine fluorophore. Sialylated and asialoglycans can be resolved using the same operating conditions.

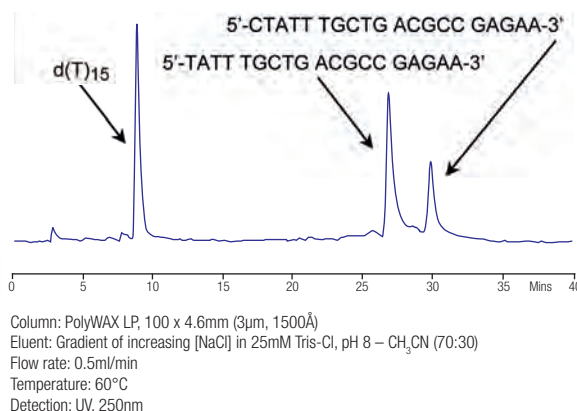

Column: PolyWAX LP, 100 x 4.6mm (3µm, 1500Å)
Eluent: Gradient of increasing [NaCl] in 25mM Tris-Cl, pH 8 – CH₃CN (70:30)
Flow rate: 0.5ml/min
Temperature: 60°C
Detection: UV, 250nm

Figure 5. Anion-exchange of oligonucleotides

PolySULFOETHYL A™

This strong cation-exchange (SCX) material was developed specifically for the HPLC of peptides, fractionating peptides by charge rather than polarity. Selectivity complements that of reversed-phase columns. Compared to other SCX materials based on sulphopropyl groups, PolySULFOETHYL A™ is unusually hydrophilic. This leads to higher recovery and higher capacity.

PolySULFOETHYL A is widely used in proteomics for the fractionation and identification of difficult proteins from complex tissue or cell extracts using 2D LC-MS/MS. By combining complementary HPLC techniques, an increased amount of information can be obtained. Different methods must be used for water-soluble and water-insoluble proteins, as shown in Figure 6. Some tryptic peptides from membrane proteins may be too hydrophobic for reversed-phase HPLC. A sequence of separations including PolySULFOETHYL A and/or PolyHYDROXYETHYL A materials provide a suitable alternative.

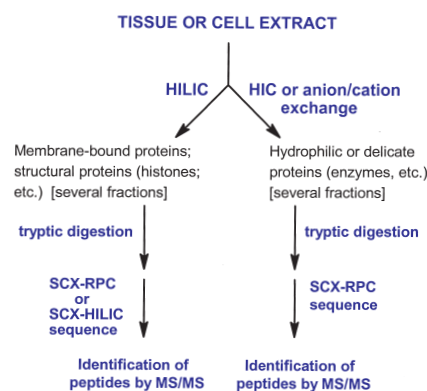

Figure 6

Electrostatic Repulsion – Hydrophilic Interaction Chromatography (ERLIC)

The term ERLIC was devised by PolyLC, for HILIC separations where an ionic column surface chemistry is used to repel a common ionic polar group on an analyte or within a set of analytes. The column has the same charge as the sample solutes. The eluent contains enough organic solvent so that hydrophilic interaction keeps the solutes on the column despite the electrostatic repulsion. The pH of the eluent is selected to ensure that the solutes do have the same charge as the column. Some separations that would normally require a gradient can be done isocratically using ERLIC.

Applications of ERLIC include:

- Cation-exchange columns (PolySULFOETHYL A or PolyCAT A) are used for negatively charged solutes such as nucleotides and nucleic acids.
- Anion-exchange columns (PolyWAX LP) are used for amino acids, peptides and proteins. ERLIC of peptides on PolyWAX LP at pH 2 can be used to separate phosphopeptides from nonphosphorylated peptides.

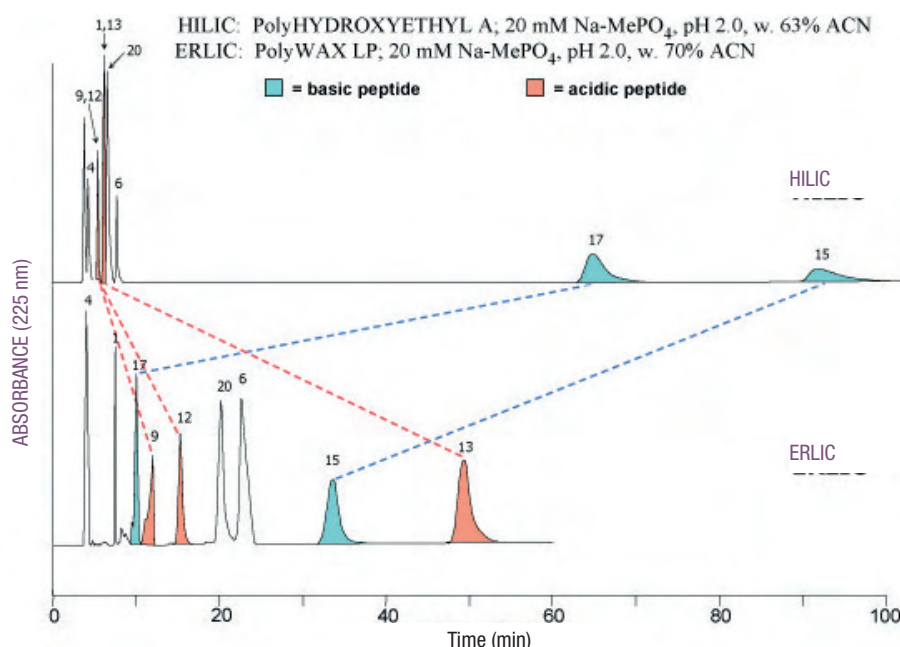

Figure 7. HILIC vs ERLIC separation of peptides

Figure 7 shows the elution of a mixture of acidic, basic and neutral peptides by HILIC on a PolyHYDROXYETHYL A column and ERLIC on a PolyWAX LP column. On the PolyHYDROXYETHYL A column, the basic peptides are much better retained than the neutral or acidic peptides, since basic solutes are the most polar of all. With the PolyWAX LP column, selective repulsion of the basic peptides puts them in the same elution time frame as the other peptides.

PolyPROPYL A™, PolyETHYL A™ and PolyMETHYL A™

These materials separate proteins on the basis of hydrophobicity, using totally aqueous buffers and retaining tertiary structure and biological activity. Elution is typically with a decreasing salt gradient of sulphate or phosphate. The relative hydrophobic character of PolyPROPYL A™, PolyETHYL A™ and PolyMETHYL A™ is 100, 60 and 15 respectively.

Sodium Dodecyl Sulphate (SDS) Removal

SDS is sometimes used to solubilise proteins. However, its presence interferes with subsequent bioanalysis. It can be removed by either:

1. Use of PolyHYDROXYETHYL A in HILIC mode
2. Use of specific PolyLC SPE cartridges in reversed-phase mode

Ordering Information – PolyLC Phases

Formulating Catalogue Numbers

Select column dimensions and phase from the table, then complete the catalogue number by adding a suffix to specify pore diameter as follows:

Pore Diameter (Å)	60	100	200	300	500	1000	1500
Catalogue No. Suffix	-006	-01	-02	-03	-05	-10	-15

Example:

PolyCAT A column (200 x 4.6mm) with 300Å pores would be 204CT0503.

Please note that not all phases are available in all pore sizes.

For bulk material part numbers, specify pore diameter with the same suffixes as for column materials.

Example: Bulk material of PolyCAT A with 300Å pores and 5µm particle size would be BMCT0503.

Columns

PolyLC 5µm Phase ²	Column Dimensions ¹ (mm)							
	100 x 2.1	200 x 2.1	35 x 4.6	100 x 4.6	200 x 4.6	200 x 9.4	250 x 9.4	250 x 21.0
PolyCAT A	102CT05- -	202CT05- -	3.54CT05- -	104CT05- -	204CT05- -	209CT05- -	259CT05- -	2521CT05- -
PolyPROPYL A	102PR05- -	202PR05- -	3.54PR05- -	104PR05- -	204PR05- -	209PR05- -	259PR05- -	2521PR05- -
PolyETHYL A	102ET05- -	202ET05- -	3.54ET05- -	104ET05- -	204ET05- -	209ET05- -	259ET05- -	2521ET05- -
PolyMETHYL A	102ME05- -	202ME05- -	3.54ME05- -	104ME05- -	204ME05- -	209ME05- -	259ME05- -	2521ME05- -
PolyWAX LP	102WX05- -	202WX05- -	3.54WX05- -	104WX05- -	204WX05- -	209WX05- -	259WX05- -	2521WX05- -
PolyHYDROXYETHYL A	102HY05- -	202HY05- -	3.54HY05- -	104HY05- -	204HY05- -	209HY05- -	259HY05- -	2521HY05- -
PolyGLYCOPLEX	102GL0500	202GL0500	3.54GL0500	104GL0500	204GL0500	209GL0500	259GL0500	2521GL0500
PolySULFOETHYL A	102SE05- -	202SE05- -	3.54SE05- -	104SE05- -	204SE05- -	209SE05- -	259SE05- -	2521SE05- -

Guard Cartridges³, Solid Phase Extraction Cartridges and Bulk Material

PolyLC 5µm Phase ²	Guard Cartridge Dimensions ^{4,5} (mm)		Solid Phase Extraction Cartridges (10/pk)	Bulk Material/g
	10 x 2.1	10 x 4.0		
PolyCAT A	J22GCCT05- -	JGCCT05- -	SPECT1203	BMCT05- -
PolyPROPYL A	J22GCPR05- -	JGCP05- -	SPEPR1203	BMP05- -
PolyETHYL A	J22GCET05- -	JGCET05- -	SPEET1203	BMET05- -
PolyMETHYL A	J22GCME05- -	JGCME05- -	SPEME1203	BMME05- -
PolyWAX LP	J22GCWX05- -	JGCWX05- -	SPEWX1203	BMWX05- -
SDS Removal	J2SDS	J4SDS	SPESDS1203	BMSDS05- -
PolyHYDROXYETHYL A	J22GCHY05- -	JGCHY05- -	SPEHY1203	BMHY05- -
PolyGLYCOPLEX	J22GCGL0500	JGCGL0500	SPEGL1200	BMGL0500
PolySULFOETHYL A	J22GCSE05- -	JGCSE05- -	SPESE1203	BMSE05- -

¹ Packed capillaries and 1mm i.d. columns also available

² 3 and 12µm particle size material also available

³ Disposable Javelin design. No additional holder required

⁴ 20 x 4.0 and 10 x 1.0mm cartridges also available

⁵ Waters compatible cartridges available

Princeton Chromatography, Inc., New Jersey manufactures both HPLC and SFC columns. The company is particularly well known for the development of innovative SFC bonded phases and has been a pioneer of the technique for many years.

Princeton SFC Columns

Supercritical Fluid Chromatography (SFC) applications typically require polar stationary phases such as silica, amino and diol. Although these phases are adequate for many applications, there is still a need for additional polar phases to meet the demands of difficult separations.

Princeton Chromatography has led the way in developing a series of amide, urea and pyridine phases that enhance the capability of the SFC technique by providing increased selectivity and loading capacity. Princeton Chromatography was the first company to develop and market the 2-Ethylpyridine phase which was launched in 2001 and later the 4-Ethylpyridine phase. PrincetonSFC™ 2-Ethylpyridine has become the column of choice for achiral SFC analysis of basic compounds. This phase generally requires no addition of amines to the eluent, producing excellent peak shape and reproducibility.

A diol phase is a popular and versatile stationary phase for SFC. Princeton Chromatography has also developed several different hydroxylated stationary phases, to give alternative selectivity and retention characteristics to the traditional diol. These phases are often a good starting point for the analysis of acidic compounds.

Figure 1 shows the structures of a selection of the Princeton SFC phases. The full range of available phases is listed on page 132.

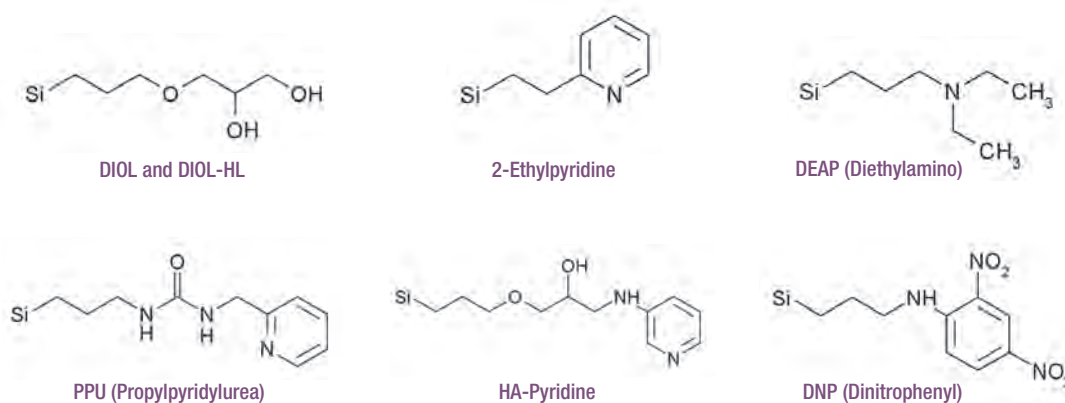

Figure 1. Structures of 6 of the many PrincetonSFC phases

PrincetonSFC analytical columns are available with lengths of 50 to 250mm and i.d.s of 2.0, 3.0, 4.0 or 4.6mm. All PrincetonSFC columns are individually quality assured by SFC. Particle sizes are 3, 5 and 10µm, with an additional 2.5µm particle phase column available for the PrincetonSPHER 2-Ethylpyridine phase.

PrincetonSFC™ Semi-Preparative and Preparative Columns

All Princeton semi-preparative and preparative SFC columns are packed using the same high quality bonded phases as the corresponding analytical columns, making scale-up from analytical dimensions seamless and easy. Princeton preparative columns are available with i.d.s from 7.8mm to 50.0mm and in lengths from 50mm to 250mm. All columns are quality controlled by SFC and individual SFC documentation is included with each column.



The ordering information for 250 x 4.6mm, 250 x 10mm and 250 x 21.2mm i.d. columns is given on page 132. Please enquire for all other dimensions.

PrincetonSFC™ Columns (continued)

The extensive range of PrincetonSFC™ phases is listed below. Many phases are available with pore sizes of 60Å or 100Å and with particle sizes of 3, 5 or 10µm. Semi-preparative and preparative columns (≥7.8mm i.d.) can be supplied packed with 5 and 10µm particles.

PrincetonSFC Phases

Phase	Pore Size (Å)	Particle Size (µm)	Ordering Information (5µm phase)		
			250 x 4.6mm ¹	250 x 10.0mm ¹	250 x 21.2mm ¹
2-Ethylpyridine	60	3, 5, 10	250046-01577	250100-01577	250212-01577
	100	2.5, 3, 5, 10	250046-03577	250100-03577	250212-03577
Silica	60	3, 5, 10	250046-01510	250100-01510	250212-01510
	100	3, 5, 10	250046-03510	250100-03510	250212-03510
Cyano	60	3, 5, 10	250046-01507	250100-01507	250212-01507
	100	3, 5, 10	250046-03507	250100-03507	250212-03507
DIOL	60	3, 5, 10	250046-01509	250100-01509	250212-01509
	100	3, 5, 10	250046-03509	250100-03509	250212-03509
Amino	60	3, 5, 10	250046-01508	250100-01508	250212-01508
	100	3, 5, 10	250046-03508	250100-03508	250212-03508
DEAP (Diethylamino)	60	3, 5, 10	250046-01575	250100-01575	250212-01575
DIOL-HL	60	5, 10	250046-01579	250100-01579	250212-01579
2CN:DIOL	60	3, 5, 10	250046-01586	250100-01586	250212-01586
	100	3, 5, 10	250046-03586	250100-03586	250212-03586
Benzamide	100	3, 5, 10	250046-03576	250100-03576	250212-03576
PA (Propylacetamide)	60	3, 5, 10	250046-01580	250100-01580	250212-01580
PPU (Propylpyridylurea)	100	3, 5, 10	250046-03582	250100-03583	250212-03582
Propylurea	100	3, 5, 10	250046-03536	250100-03536	250212-03536
DNP (Dinitrophenyl)	100	3, 5, 10	250046-03593	250100-03593	250212-03593
Pyridine Amide	60	3, 5, 10	250046-01583	250100-01583	250212-01583
4-Ethylpyridine	60	3, 5, 10	250046-01590	250100-01590	250212-01590
	100	3, 5, 10	250046-03590	250100-03590	250212-03590
Methane Sulfonamide (MeSAM)	60	3, 5, 10	250046-01591	250100-01591	250212-01591
Benzene Sulfonamide (BeSAM)	100	3, 5, 10	250046-03592	250100-03592	250212-03592
HA-Pyridine	60	3, 5, 10	250046-01587	250100-01587	250212-01587
HA-Dipyridyl	100	3, 5, 10	250046-03588	250100-03588	250212-03588
HA-DEA (Diethylamino)	60	3, 5, 10	250046-01565	250100-01565	250212-01565
HA-DHP (Dihydroxypropyl)	100	3, 5, 10	250046-03569	250100-03569	250212-03569

¹ Other dimensions available – please enquire

Figures 2 and 3 show the SFC separation of β-blockers on PrincetonSFC Silica and a mixture of test compounds on PrincetonSFC Methane Sulfonamide respectively.

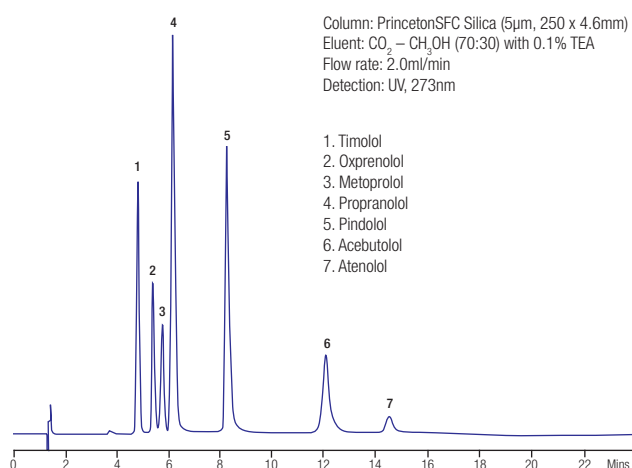

Figure 2. SFC separation of β-blockers

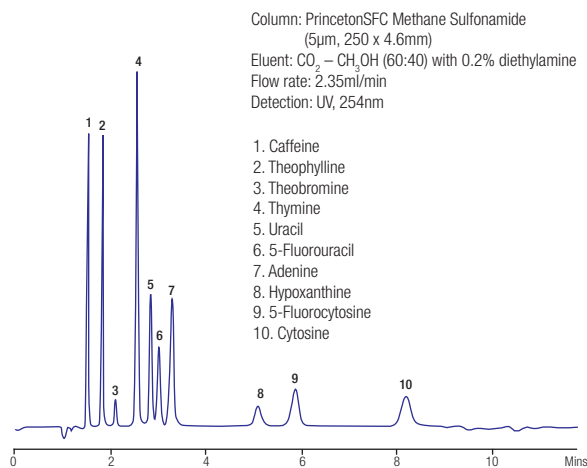

Figure 3. SFC separation of test compounds on PrincetonSFC Methane Sulfonamide

PrincetonSFC™ Columns (continued)

The table below shows typical starting conditions for an analytical SFC assay. For basic analytes, a pyridine based column is a good starting point. For acidic compounds, a diol type column may be more retentive. Neutral compounds do not generally require an additive for elution.

Typical Analytical Conditions for Achiral SFC

Stationary Phase	Silica, Diol, 2-Ethylpyridine etc. (see Table on page 132)
Column Dimensions	
Length	5, 10, 150, 250mm
i.d.	2.0, 3.0, 4.0, 4.6mm
Mobile Phase	Flow rate: 1 - 5ml/min
CO ₂	
Modifier	Methanol (or ethanol)
Additive 1*	5 - 20mM ammonium formate or acetate Ammonium hydroxide or diethylamine (for basic compounds) Formic acid or acetic acid (for acidic compounds)
Gradient	5 - 50% modifier
Pressure	100 - 200 bar
Temperature	35 - 45°C
Detection	UV, MS, ELSD, CAD

* 1 - 5% water may also be added if required

Figure 4 shows the separation of a mixture of 8 basic compounds on a 150 x 4.6mm PrincetonSFC™ Propylurea column. Figure 5 illustrates the effect on selectivity and retention times of changing the chemistry of the stationary phase. In each case methanol was used as the modifier without the addition of any additives.

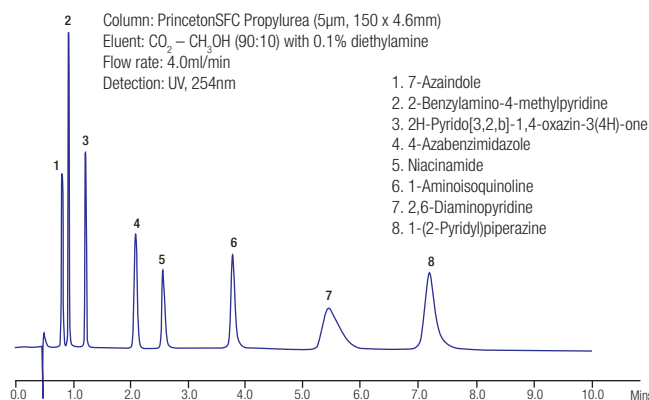

Figure 4. SFC separation of basic compounds

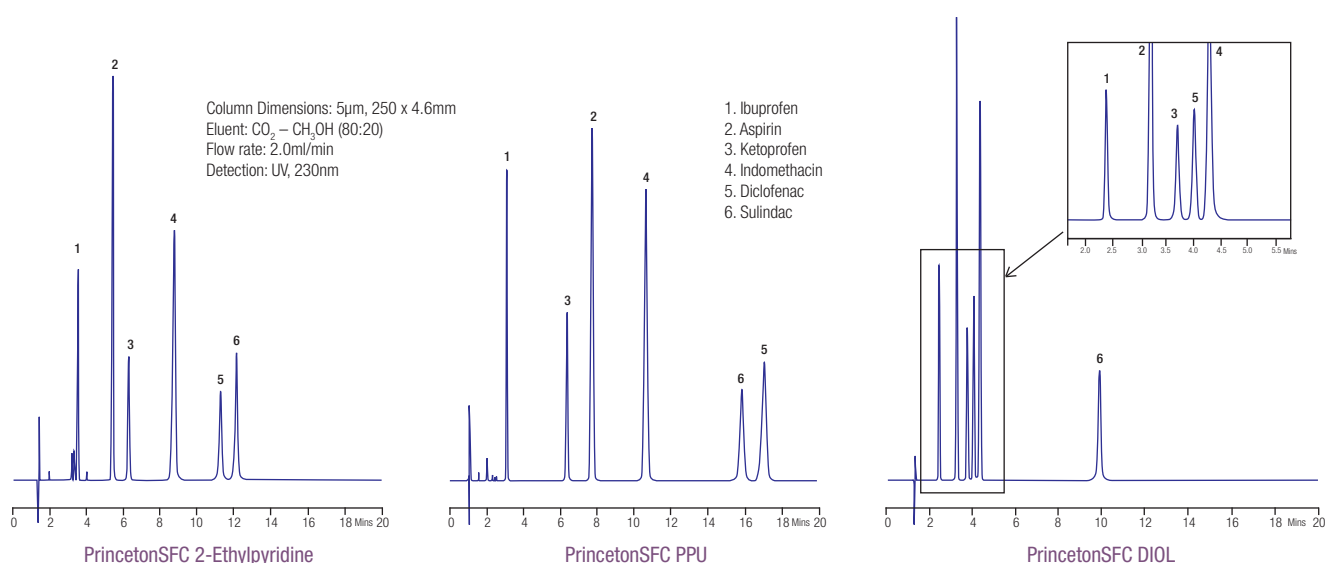

Figure 5. Selectivity of PrincetonSFC 2-Ethylpyridine, PPU and DIOL

Bulk Material

The majority of Princeton Chromatography SFC and HPLC phases are offered in bulk form, in a variety of particle sizes ranging from 10µm to ≥20µm. Please enquire for availability.

PrincetonSPHER™ HPLC Columns

Princeton Chromatography also manufactures a range of porous silica bonded HPLC columns. An overview of a selection of these phases is given below.

PrincetonSPHER™ HPLC Phases

PrincetonSPHER Phase	Particle Size (µm)	Pore Size (Å)	Surface Area (m ² /g)	Carbon Load (%)	Endcapped	Phase Code
C18	3, 5, 10	60, 100, 300 ¹	500, 325, 100	23, 19, 8	Yes	01
C8	3, 5, 10	60, 100, 300 ¹	500, 325, 100	15, 11, 5	Yes	02
C6	3, 5, 10	60, 100	500, 325	10, 8	Yes	03
C4	3, 5, 10	60, 100, 300 ¹	500, 325, 100	8, 6, 3	No	04
Phenyl	3, 5, 10	60, 100, 300 ¹	500, 325, 100	16, 12, 5	Yes	05
PFP	3, 5, 10	60, 100	500, 325	12, 9	Yes	06
CN	3, 5, 10	60, 100, 300 ¹	500, 325, 100	8, 6, 3	No	07
NH2	3, 5, 10	60, 100, 300 ¹	500, 325, 100	6, 4, 3	No	08
Diol	3, 5, 10	60, 100, 300 ¹	500, 325, 100	6, 4, 2	No	09
Silica	3, 5, 10	60, 100, 300 ¹	500, 325, 100	N/A	N/A	10
HTS (C12)	3, 5, 10	60	500	16	Yes	70
C27	3, 5, 10	100	325	19	Yes	71
C30	3, 5, 10	200	200	19	No	74
Cyclohexyl	3, 5, 10	60	500	12	Yes	43
Diphenyl	5	60	500	10	Yes	51
Fluoropropyl	5, 10	100	325	5	No	41
Fluorooctyl (FO)	5, 10	100	325	8	Yes	42
ULTIMA C18	3, 5, 10	100	325	16	Yes	21
ULTIMA C8	3, 5, 10	100	325	13	Yes	22
ULTIMA Phenyl	3, 5, 10	100	325	12	Yes	23

¹ 300Å phases not available with 3µm particle size

Princeton Chromatography HPLC Phases

PrincetonSPHER-60 Series phases (60Å pore size) are optimal for compounds under 1000MW. In most cases, the high surface area (500m²/g) leads to longer retention times than with the corresponding 100Å materials. All PrincetonSPHER-60 columns are packed with high purity silica, bonded to ensure the highest standards of quality.

PrincetonSPHER-100 Series columns are Princeton Chromatography's most popular. With a pore size of 100Å and an average surface area of 325m²/g these columns are extremely versatile and excellent for method development.

PrincetonSPHER-300 Series (300Å pore size) are the columns of choice for large molecules such as proteins and peptides. The low surface area of these packing materials is beneficial for separations requiring low percentages of organic modifiers.

PrincetonSPHER-HTS is a 60Å pore size C12 phase designed for **High Throughput Screening**. The unique structure of this C12 ligand facilitates rapid equilibration between gradient runs.

PrincetonSPHER C27 is a 100Å proprietary phase containing a well-defined and reproducible branched chain hydrocarbon ligand. The phase shows enhanced retention for most polar compounds and can be used with fully aqueous mobile phases.

PrincetonSPHER C30 is a 200Å pore size material bonded with a distribution of long chain hydrocarbons that have an average length of C30. This material has been found to successfully separate many isomers in the carotenoid family of long chain molecules. It has also proved useful for the analysis of some larger molecules such as proteins and peptides.

Princeton ULTIMA bonded phases contain an amide polar embedded functionality, which deactivates neighbouring free silanol groups and enhances the wettability of the bonded ligands. The phases are compatible with the use of 100% aqueous eluents and are available as C18, C8 and Phenyl bonded phases.

Please enquire for ordering information for any PrincetonSPHER HPLC column or guard.



PrincetonSPHER™ HPLC Columns (continued)

PrincetonSPHER™ Column Dimensions

Analytical HPLC columns can be supplied with lengths of 50, 75, 100, 150 and 250mm and with i.d.s of 2.0, 3.0, 4.0 and 4.6mm. Preparative HPLC columns can be supplied with lengths of 50, 100, 150 and 250mm and with i.d.s of 7.8, 10.0, 21.2, 30.0 and 50.0mm. Guard cartridges for analytical and preparative dimension columns are available – please enquire.

Creating a Part Number:

All Princeton Chromatography HPLC column part numbers are of the format XY-ABC

where X = column length in mm

Y = code for column i.d.

A = code for pore size

B = code for particle size

C = code for phase type (included in main phase specification table, page 134)

When creating a part number, please substitute the appropriate codes into this basic format.

e.g. For a 3µm 150 x 4.6mm i.d. PrincetonSPHER-100 C18 column, the part number is 150046-03301.

Column i.d. (mm)	2.0	3.0	4.0	4.6	7.8	10.0	21.2	30.0	50.0
Code	020	030	040	046	078	100	212	300	500

Pore Size (Å)	60	100	200	300	Particle Size (µm)	3	5	10
Code	01	03	07	08	Code	3	5	0

Figures 6 and 7 show the separation of diuretics and vanillins on PrincetonSPHER C18 and PrincetonSPHER Fluorooctyl (FO) respectively.

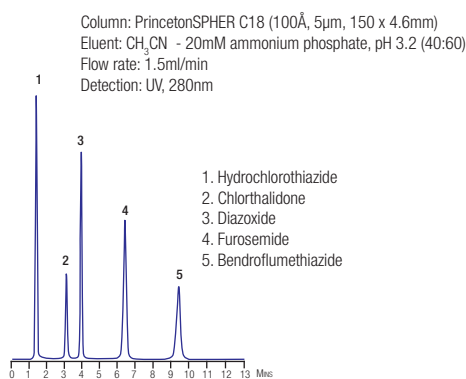

Figure 6. Diuretics on PrincetonSPHER C18

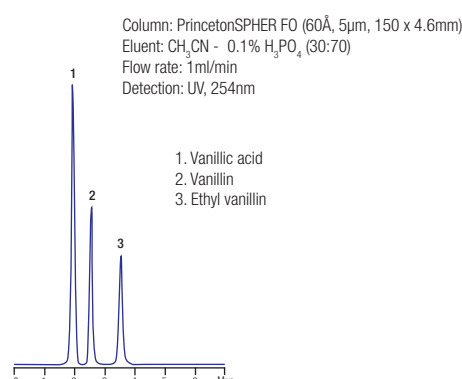

Figure 7. Vanillins on PrincetonSPHER FO

PharmaBOND

PharmaBOND columns are packed with 125Å pore size 10µm (or 5µm for C18 phase) irregular silica particles. C18, Phenyl, CN, Amino and Silica phases are available and are suitable for legacy methods specifying this phase type. They are equivalent to Waters® µBondapak® and are supplied with internal diameters of 3.9 and 4.6mm.

Ordering Information for PharmaBOND Columns

PharmaBOND Phase	Column Dimensions (mm)					Guard Cartridges (5/pk, 10 x 4.0mm)
	150 x 3.9	300 x 3.9	150 x 4.6	250 x 4.6	300 x 4.6	
5µm						
C18	150039-05501	300039-05501	150046-05501	250046-05501	300046-05501	14104-05501
10µm						
C18	150039-05001	300039-05001	150046-05001	250046-05001	300046-05001	14104-05001
Phenyl	150039-05005	300039-05005	150046-05005	250046-05005	300046-05005	14104-05005
CN	150039-05007	300039-05007	150046-05007	250046-05007	300046-05007	14104-05007
Amino	150039-05008	300039-05008	150046-05008	250046-05008	300046-05008	14104-05008
Silica	150039-05010	300039-05010	150046-05010	250046-05010	300046-05010	14104-05010

Regis® Technologies, Inc. manufactures a wide range of chiral and speciality columns for analytical to preparative applications. They are well known for their range of Pirkle type chiral stationary phases, in particular the well established Whelk-0® columns, used for analytical and preparative applications. The company also manufactures a range of polysaccharide phases, a range of RAM and IAM columns and supplies the ChiroSil range of crown ether type chiral columns manufactured by RStech Corporation of Korea (see page 137).

Pirkle Chiral Phases

Pirkle concept chiral stationary phases can be used in both normal-phase and reversed-phase modes. All columns show excellent durability due to covalent bonding and excellent chromatographic efficiency. They can be used with a wide variety of solvents and are applicable for both HPLC and SFC methods. For each phase listed in the table below, the optically active ligand is covalently bonded to 5µm, 100Å spherical silica.

Regis Pirkle Chiral Phases

Phase	Bonding	Class	Typical Applications
α-Burke 2	N-3,5-dinitrobenzoyl-α-amino-2,2-dimethyl-4-pentenyl phosphonate	π-electron acceptor	β-Blockers, amino alcohols
β-Gem 1	N-3,5-dinitrobenzoyl-3-amino-3-phenyl-2-(1,1-dimethylethyl)-propanoate	π-electron acceptor	Anilide derivatives of wide range of carboxylic acids
DACH-DNB	3,5-Dinitrobenzoyl derivative of 1,2-diaminocyclohexane	π-electron acceptor/donor	Broad range
Leucine	3,5-Dinitrobenzoylleucine	π-electron acceptor	Benzodiazepines
Phenylglycine	3,5-Dinitrobenzoylphenylglycine	π-electron acceptor	Wide variety of compounds containing π-basic groups
Pirkle 1-J	3-(3,5-Dinitrobenzamido)-4-phenyl-β-lactam	π-electron acceptor	Underivatized β-blockers, arylpropionic acids
ULMO	3,5-Dinitrobenzoyl derivative of diphenylethylene-diamine	π-electron acceptor/donor	Wide range, particularly aryl carbinols
Whelk-01 Whelk-02	1-(3,5-dinitrobenzamido)-tetrahydrophenanthrene	π-electron acceptor/donor	Broad range of compounds

Additional features of the Pirkle type phases include:

1. The ability to invert elution order by using the same type of chiral stationary phase (CSP) but with the opposite absolute configuration enables trace enantiomers to be eluted before the major. This is beneficial for enantiomeric purity determinations and for preparative separations.
2. All of Regis' Pirkle columns are available in both analytical and preparative sizes. The high loading factors offered by these phases make them particularly suited for scaling up.

Whelk-0®1 is the most widely applicable of the Regis chiral stationary phases, due to the incorporation of both π-acceptor and π-donor characteristics. It was originally designed for the separation of underivatized non-steroidal anti-inflammatory drugs, but shows versatility in the analysis of a wide range of compounds, including amides, epoxides, esters, ureas, carbamates, ethers, aldehydes, ketones, carboxylic acids and alcohols. The newer Whelk-01 phase, based on 5µm Kromasil silica, shows higher efficiencies and greater resolving power in both HPLC and SFC modes than the original 5µm Whelk-01 phase based on Exsil silica and is now recommended for all new method development. Figures 1 and 2 show comparisons of the HPLC and SFC performances of these Whelk-01 phases for modafinil and chlormezanone respectively.

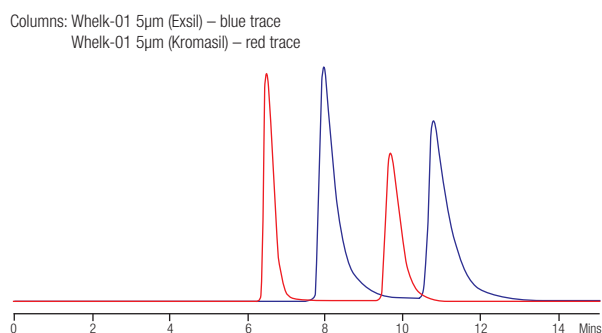

Figure 1. HPLC separation of modafinil

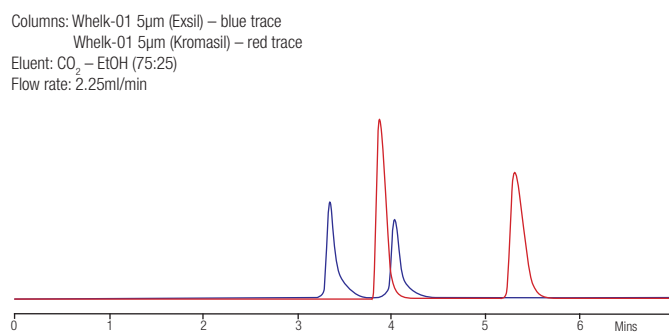

Figure 2. SFC separation of chlormezanone

Whelk-0®2 is the covalent trifunctional version of the Whelk-01. It shows similar enantioselectivity as the Whelk-01, but demonstrates enhanced stability with strong organic modifiers.

Please enquire for ordering information on all Regis products.

RegisCell®, RegisPack® and RegisPack CLA-1™

RegisCell® and RegisPack® chiral columns are polysaccharide based stationary phases. They are produced using a unique manufacturing process involving the coating of the polysaccharide cellulose and amylose chiral selectors respectively onto a high purity wide pore (1000Å) silica. Columns can be used in both HPLC and SFC modes. Figure 3 shows the fast SFC analysis of atenolol in less than one minute on a RegisCell column.

The newer RegisPack CLA-1™ is a coated chlorinated polysaccharide (amylose) phase. It shows complementary selectivity to the other Regis phases and can be a useful addition to a screening process. Figure 4 shows the separation of the four diastereomers of cyclandelate by HPLC on a RegisPack CLA-1 column.

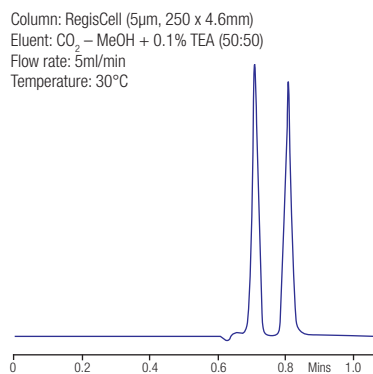

Figure 3. Fast SFC separation of atenolol

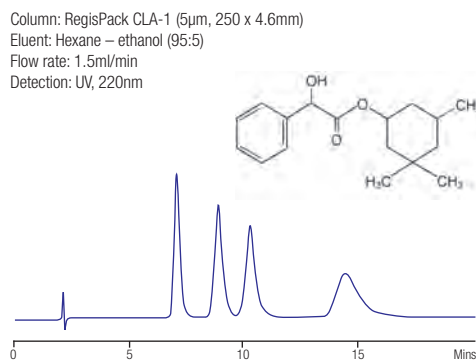

Figure 4. Cyclandelate on RegisPack CLA-1

ChiroSil®

The ChiroSil® RCA(+) and SCA(-) crown ether chiral stationary phases are effective for the analysis of amino acids and primary amines. The high resolution capability of these phases enables applications to be scaled up from analytical to preparative dimensions. The availability of both enantiomeric forms of the phase enables the elution order to be inverted so that a trace enantiomer can be eluted first.

Other Products

Restricted Access Media (RAM)

RAM columns permit the direct HPLC analysis of drugs in a protein matrix without the use of multi-stage clean-up procedures. Two types of RAM direct injection technologies are available. Both consist of a distinct inner and outer surface. Large proteins (>12,000 MW) move through the column repelled by the outer hydrophilic surface. They are too large to access the internal surface of the pores and hence are eluted at the column's void volume. Analytes pass through the internal pores and are retained by the inner hydrophobic phase.

Immobilised Artificial Membrane (IAM)

IAM chromatography phases prepared from analogues of phosphatidylcholine mimic the surface of a biological cell membrane. Their use provides a method for the prediction of drug membrane partitioning and large scale drug membrane screening. Columns are used primarily for membrane protein purification and in drug discovery for predicting drug membrane permeability.

Ion Pairing Reagents

Ion pairing reagents can be used to selectively increase the retention of charged analytes on conventional hydrophobic HPLC phases. Regis manufactures both anionic sulphonate (S-Series) and cationic quaternary amine (Q-Series) ion pairing reagents with varying alkyl chain lengths. The S-Series reagents are available as 0.5M solutions of alkyl sulphonates (S5-S8, S12) or as bulk powder. The Q-Series consists of 0.5M solutions of quaternary alkytriethylamines (Q5-Q8, Q12). Method development kits are also available.

GC Derivatization Reagents

Regis manufactures a wide range of high purity derivatization reagents for GC. These include reagents for silylation, alkylation and acylation reactions. Please see page 171 for further details.

Please enquire for ordering information on all Regis products.

- Silica- and polymer-based phases
- Columns for all chromatographic modes
- Wide application range
- Capillary, microbore, analytical and preparative dimensions



Showa Denko K.K., Japan manufactures the Shodex® line of HPLC columns for the pharmaceutical and biotechnology industries. A wide range of products with both silica-based and polymer-based materials is available. An overview of the products is shown on the following pages: reversed-phase (page 138), ligand exchange (page 139), ion-exchange and ion chromatography (page 140), size exclusion (page 141), HIC (page 142) and affinity (page 142). Please enquire for additional details.

Shodex Reversed-Phase Columns

The Shodex product range contains both polymer-based and silica-based phases. Please enquire for ordering details where not listed.

Reversed-Phase (Polymer-based) Phases

The table below lists the polymer-based phases available.

Column Series	Base Material	Functional Group	Comments/Applications
RSpak RP18, DS	Styrene-divinylbenzene	-	Analysis of proteins and peptides
RSpak DE, GOLF, CARB	Polymethacrylate	-	DE series columns have similar selectivity to C18 columns
RSpak DM-614	Polyhydroxymethacrylate	-	Suitable for analysis of amino acids and polypeptides
RSpak NN	Polyhydroxymethacrylate	Sulpho	Suitable for separation of mixtures of neutral and ionic compounds
RSpak JJ-50	Polyvinyl alcohol	Quaternary ammonium	
Asahipak ODP	Polyvinyl alcohol	Octadecyl	Large pore size phases, suitable for high molecular weight compounds eg. proteins, as well as low molecular weight compounds. LC-MS applications
Asahipak ODP2 HP	Polyhydroxymethacrylate	Octadecyl	
Asahipak C8P-50	Polyvinyl alcohol	Octyl	
Asahipak C4P-50	Polyvinyl alcohol	Butyl	
Asahipak NH2P	Polyvinyl alcohol	Amino	Analysis of saccharides (NP)

Shodex ODP2 HP is a macroporous polyhydroxymethacrylate reversed-phase material offering better efficiencies than many other resin-based phases and comparable to that of silica-based C18 columns. It has a recommended pH range of 3 to 12. The high polarity and small pore size (40Å) of this phase is designed to exclude proteins and can be used for the analysis of drugs in biological samples ie. as restricted access material (see Figure 1 for example).

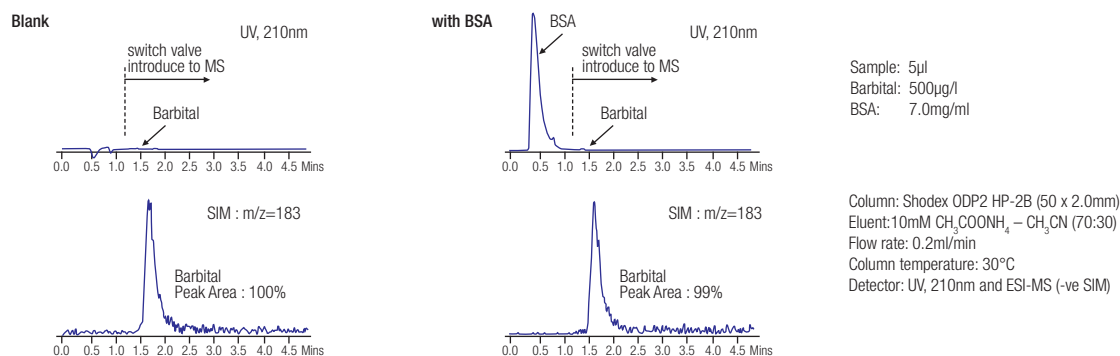

Figure 1. LC-MS of barbitol in BSA

Ordering Information - Shodex ODP2 HP

Product	Particle Size (µm)	Column Dimensions (mm)	Catalogue No.
ODP2 HP-4B	5	50 x 4.6	F7622001
ODP2 HP-4D	5	150 x 4.6	F7622002
ODP2 HP-4E	5	250 x 4.6	F7622003
ODP2 HPG-4A	5	10 x 4.6 (guard column, 1/pk)	F6714010
ODP2 HP-4GC	5	10 x 4.0 (guard cartridge, 3/pk) ¹	F6714012
ODP2 HP-2B	5	50 x 2.0	F7622004
ODP2 HP-2D	5	150 x 2.0	F7622005
ODP2 HPG-2A	5	10 x 2.0 (guard column, 1/pk)	F6714011

¹ Use with guard cartridge holder HLD-4GC (Cat. No. F8700020).

Reversed-Phase (Silica-based) Phases

Please enquire for details of reversed-phase silica-based columns, including Silica NPE (nitrophenylethyl) and Silica PYE (pyrenylethyl).

Shodex® Columns for Saccharide Analysis

Ligand Exchange Phases (Shodex SUGAR Series)

Column Series	Base Material	Functional Group	Comments/Applications
SUGAR SH	Styrene-divinylbenzene	Sulpho (H ⁺)	Separation of saccharides by ligand exchange, size exclusion, ion exclusion and normal-phase. Suitable for separation of sugars and sugar alcohols
SUGAR SC	Styrene-divinylbenzene	Sulpho (Ca ²⁺)	
SUGAR SP	Styrene-divinylbenzene	Sulpho (Pb ²⁺)	
SUGAR SZ	Styrene-divinylbenzene	Sulpho (Zn ²⁺)	
SUGAR KS	Styrene-divinylbenzene	Sulpho (Na ⁺)	Separation of saccharides by size exclusion and ligand exchange
USPpak MN	Styrene-divinylbenzene	Sulpho (Ca ²⁺)	Analysis of mannitol by USP method

There are two series of Shodex® columns for saccharide analysis – the SUGAR series for operation in ligand exchange mode and Asahipak NH2P-50 polymeric amino columns for normal-phase and HILIC modes.

A. Shodex SUGAR Series

The SUGAR series columns are based on polystyrene-divinylbenzene copolymer with strong cation-exchange resin incorporating functional sulpho groups coupled with metal counter ions (H⁺, Ca²⁺, Pb²⁺, Zn²⁺, Na⁺).

B. Shodex Asahipak NH2P

Shodex Asahipak NH2P is an amino bonded column in which polyamine is bonded to a hydrophilic polyvinyl alcohol polymer. The high separation power of conventional silica-based columns is maintained, whilst showing an increased usable pH range (2 – 13) and increased robustness. Figure 2 illustrates the reproducibility over time obtained from the polymeric Asahipak NH2P column.

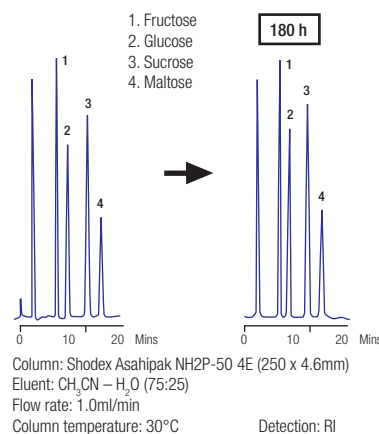

Figure 2. Reproducibility with Asahipak NH2P-50

Ordering Information - Columns for Saccharide Analysis

Product	Counter Ion	Separation Mode	Exclusion Limit (Da)	Particle Size (µm)	Column Dimensions ¹ (mm)	Catalogue No.
SUGAR SH1011	H ⁺	SEC + IEX	1,000	6	300 x 8.0	F6378100
SUGAR SH1821	H ⁺	SEC + IEX	10,000	6	300 x 8.0	F6378101
SUGAR SH-G	H ⁺	-	Guard column	10	50 x 6.0	F6700080
SUGAR SC1011	Ca ²⁺	SEC + LEX	1,000	6	300 x 8.0	F6378102
SUGAR EP SC1011-7F	Ca ²⁺	SEC + LEX	1,000	8	300 x 7.8	F6379300
SUGAR SC1821	Ca ²⁺	SEC + LEX	10,000	6	300 x 8.0	F6378103
SUGAR SC-LG	Ca ²⁺	-	Guard column	10	50 x 6.0	F6700090
SUGAR SP0810	Pb ²⁺	SEC + LEX	1,000	7	300 x 8.0	F6378105
SUGAR SP-G	Pb ²⁺	-	Guard column	10	50 x 6.0	F6700081
SUGAR SC1211	Ca ²⁺	NP + LEX	-	6	250 x 6.0	F7001400
SUGAR SC-G	Ca ²⁺	-	Guard column	10	10 x 4.6	F6700120
SUGAR SZ5532	Zn ²⁺	NP + LEX	-	6	150 x 6.0	F7001300
SUGAR SZ-G	Zn ²⁺	-	Guard column	6	10 x 4.6	F6700110
SUGAR KS-801	Na ⁺	SEC + LEX	1,000	6	300 x 8.0	F6378010
SUGAR KS-802	Na ⁺	SEC + LEX	10,000	6	300 x 8.0	F6378020
SUGAR KS-803	Na ⁺	SEC	50,000	6	300 x 8.0	F6378025
SUGAR KS-804	Na ⁺	SEC	400,000	7	300 x 8.0	F6378035
SUGAR KS-805	Na ⁺	SEC	5,000,000	17	300 x 8.0	F6378050
SUGAR KS-806	Na ⁺	SEC	50,000,000	17	300 x 8.0	F6378060
SUGAR KS-G	Na ⁺	-	Guard column	10	50 x 6.0	F6700020
SUGAR KS-807	Na ⁺	SEC	200,000,000	30	300 x 8.0	F6378070
SUGAR KS-807G	Na ⁺	-	Guard column	30	50 x 8.0	F6700021
USPpak MN-431	Ca ²⁺	LEX	-	8	250 x 4.0	F6379230
Asahipak Phases						
NH2P-40 3E	-	NP/HILIC	-	4	250 x 3.0	F7630007
NH2P-50G 3A	-	-	Guard column	5	10 x 3.0	F6710030
NH2P-50 4D	-	NP/HILIC	-	5	150 x 4.6	F7630002
NH2P-50 4E	-	NP/HILIC	-	5	250 x 4.6	F7630001
NH2P-50G 4A	-	-	Guard column	5	10 x 4.6	F6710016
NH2P-50 2D	-	NP/HILIC	-	5	150 x 2.0	F7630006
NH2P-50G 2A	-	-	Guard column	5	10 x 2.0	F6713000
NH2P-LF	-	-	Line filter	-	75 x 8.0	F6710100

¹ Preparative columns also available

Shodex® Ion-Exchange Phases

Ion-Exchange Phases

Column Series	Base Material	Functional Group	Comments/Applications		
IEC	QA	Polyhydroxymethacrylate	Quaternary ammonium	Strong anion-exchange	
IEC	DEAE	Polyhydroxymethacrylate	Diethylaminoethyl	Weak anion-exchange	Suitable for analysis of proteins, peptides, DNA, RNA, oligonucleotides
IEC	SP	Polyhydroxymethacrylate	Sulphopropyl	Strong cation-exchange	
IEC	CM	Polyhydroxymethacrylate	Carboxymethyl	Weak cation-exchange	
Asahipak	ES-502N	Polyvinyl alcohol	Diethylaminoethyl	Weak anion-exchange	
Asahipak	ES-502C	Polyvinyl alcohol	Carboxymethyl	Weak cation-exchange	
AXpak	WA	Polyhydroxymethacrylate	Diethylaminoethyl	Weak anion-exchange, suitable for analysis of nucleic acids	
CXpak	P	Styrene-divinylbenzene	Sulpho (Na ⁺)	Analysis of amino acids and amino sugars	
PIKESS	DEAE	Polyhydroxymethacrylate	Diethylaminoethyl	Weak anion-exchange	UHPLC compatible (2.5µm material)
PIKESS	SP	Polyhydroxymethacrylate	Sulphopropyl	Strong cation-exchange	

The IEC series (QA and DEAE anion-exchange phases and SP and CM cation-exchange phases) is based on polyhydroxymethacrylate. Columns are suitable for the analysis of relatively high molecular weight compounds, such as proteins. The newer PIKESS materials are non-porous 2.5µm particles, suitable for rapid protein analyses using UHPLC systems (see Figure 3).

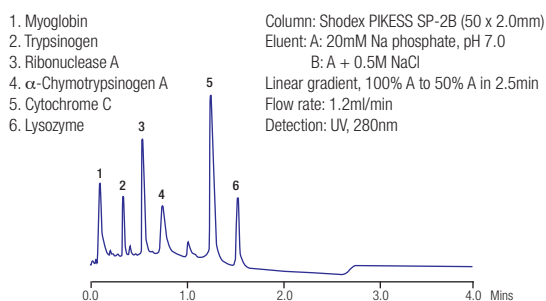

Figure 3. Rapid analysis of proteins using UHPLC and ion-exchange

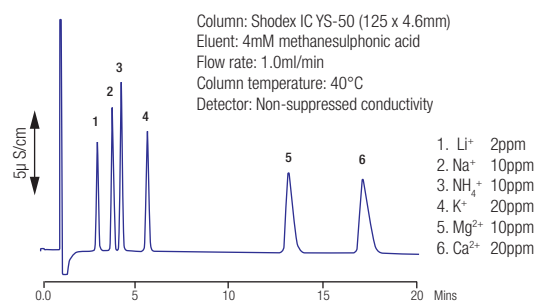

Figure 4. Separation of cations using ion chromatography

Please enquire for ordering details of ion-exchange columns.

Shodex Ion Chromatography Phases

Ion Chromatography Phases

Column Series	Base Material	Functional Group	Comments/Applications	
IC	NI, I	Polyhydroxymethacrylate	Quaternary ammonium	Anion analysis with non-suppressed detection
IC	SI	Polyvinyl alcohol	Quaternary ammonium	Anion analysis with suppressed detection
IC	Y, T, R	Styrene-divinylbenzene	Sulpho	Cations by non-suppressed detection. Y for alkylamines. T for transition metals and R for rare earth metals by post-column reaction
IC	YK	Silica	Carboxyl	Monovalent and divalent cations by non-suppressed detection
IC	YS	Silica	Carboxyl	Higher performance version of YK

A range of Shodex columns are available for both non-suppressed and suppressed ion chromatography. Columns are also supplied for analysing transition metal ions and rare earth metal ions using post-column reactions. Figure 4 shows the separation of six common cations on a Shodex IC YS-50 column with non-suppressed conductivity detection.

Ordering Information - Columns for Ion Chromatography

Column	Particle Size (µm)	Column Dimensions (mm)	Catalogue No.	Guard Column	Catalogue No.
IC NI-424	5	100 x 4.6	F6995243	IC NI-G	F6709616
IC I-524A	12	100 x 4.6	F6995240	IC IA-G	F6700400
IC Y-521	12	150 x 4.6	F6995210	IC Y-G	F6700230
IC YK-421	5	125 x 4.6	F7120012	IC YK-G	F6709608
IC YS-50	5	125 x 4.6	F7122000	IC YS-G	F6700530
IC SI-90 4E ¹	9	250 x 4.0	F6995244	IC SI-90G ¹	F6709620
IC SI-50 4E ¹	5	250 x 4.0	F6995245	IC SI-50G ¹	F6709625
IC T-521 ¹	12	150 x 4.6	F6995250	IC T-G ¹	F6700412
IC R-621	5	50 x 6.0	F6998000	IC R-G	F6709090

¹ PEEK hardware

Shodex® GFC Phases

Aqueous SEC (GFC) Phases

Column Series	Base Material	Functional Group	Comments/Applications
PROTEIN KW	Silica	Hydrophilic polymer	Analysis of high MW biological fluids. Suitable for separating proteins of MW few thousand to few million Da
OHpak SB	Polyhydroxymethacrylate	-	Analysis of water-soluble samples and for molecular weight distribution

PROTEIN KW-800 and KW400 are silica based series with high protein recovery rates. Whereas the KW-800 columns have the highest sample loading, the reduced particle size of KW400 columns enable 3-4 times greater sensitivity. Figure 5 illustrates the enhanced sensitivity achieved for a range of proteins with a KW400 column.

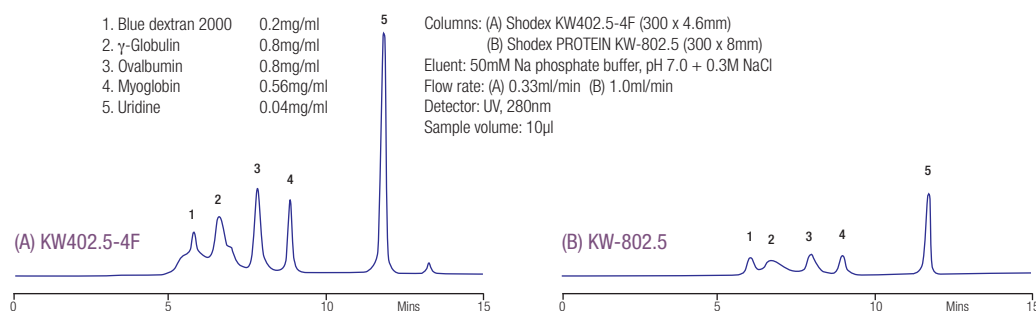

Figure 5. Comparison between KW400 and KW-800 columns

The OHpak SB-800 and SB400 series are based on polyhydroxymethacrylate and are used for the analysis of a wide range of molecular weight compounds.

Ordering Information – GFC Columns

PROTEIN Product	Particle Size (µm)	Pore Size (Å)		Exclusion Limit (Da)		Column Dimensions (mm)	Catalogue No.
		Average	Maximum	Pullulan	Protein		
KW-802.5	5	150	400	60,000	150,000	300 x 8.0	F6989000
KW-803	5	300	1,000	170,000	700,000	300 x 8.0	F6989103
KW-804	7	500	1,500	500,000	1,000,000	300 x 8.0	F6989104
KW-G	7	Guard column				50 x 6.0	F6700131
KW402.5-4F	3	150	400	60,000	150,000	300 x 4.6	F6989201
KW403-4F	3	250	800	150,000	600,000	300 x 4.6	F6989202
KW404-4F	5	500	1,500	500,000	1,000,000	300 x 4.6	F6989203
KW405-4F	5	700	2,000	1,300,000	20,000,000	300 x 4.6	F6989204
KW400G-4A	5	Guard column				10 x 4.6	F6700132

OHpak Product	Particle Size (µm)	Pore Size (Å) (Maximum)	Exclusion Limit (Da)		Column Dimensions (mm)	Catalogue No.
			Pullulan	Protein		
SB-802 HQ	8	100	4,000		300 x 8.0	F6429100
SB-802.5 HQ	6	200	10,000		300 x 8.0	F6429101
SB-803 HQ	6	800	100,000		300 x 8.0	F6429102
SB-804 HQ	10	2,000	1,000,000		300 x 8.0	F6429103
SB-805 HQ	13	7,000	4,000,000		300 x 8.0	F6429104
SB-806 HQ	13	15,000	20,000,000		300 x 8.0	F6429105
SB-806M HQ	13	15,000	20,000,000		300 x 8.0	F6429106
SB-G	10	Guard column			50 x 6.0	F6709430
SB-807 HQ	35	30,000	500,000,000		300 x 8.0	F6429108
SB-807G	35	Guard column			50 x 8.0	F6709431
SB401-4E	10	40	1,000		250 x 4.6	F6429111
SB402.5-4E	6	200	10,000		250 x 4.6	F6429112
SB403-4E	6	800	100,000		250 x 4.6	F6429113
SB404-4E	7	2,000	1,000,000		250 x 4.6	F6429114
SB400G-4A	7	Guard column			10 x 4.6	F6709432

Other Shodex® Phases

Aqueous/Organic SEC Phases

Column Series	Base Material	Functional Group	Comments/Applications
Asahipak GF	Polyvinyl alcohol	None	Both water and organic solvents can be used. Suitable for samples with both hydrophilic and hydrophobic moieties.

The Asahipak GF Series columns are based on polyvinyl alcohol and can be used with both aqueous and organic solvents. Please enquire for further details and ordering information for aqueous/organic SEC phases.

Organic SEC (GPC) Phases

Column Series	Base Material	Functional Group	Comments/Applications
GPC KF, K, KD, HFIP, LF, HT, UT, AT	Styrene-divinylbenzene	None	KF-800 series shipped in THF. K-800 series shipped in CHCl ₃ . KD-800 series shipped in DMF – suitable for assay of polar polymers. HFIP suitable for engineering plastics eg. PET, polyamides. HT, UT and AT series for higher temperature GPC.

Please enquire for further details and ordering information for organic SEC (GPC) phases.

Hydrophobic Interaction Phase

Column Series	Base Material	Functional Group	Comments/Applications
HIC PH	Polyhydroxymethacrylate	Phenyl	Analysis of proteins

The HIC PH-814 column separates proteins without denaturation. It is applicable to samples after treatment of ammonium sulphate fractions.

Organic Acids Phase

Column Series	Base Material	Functional Group	Comments/Applications
RSpak KC	Styrene-divinylbenzene	Sulpho	Analysis of organic acids by ion exclusion and reversed-phase modes

Shodex® RSpak KC columns are suitable for the analysis of organic acids by ion exclusion and reversed-phase modes.

Affinity Phases

Column Series	Base Material	Functional Group	Comments/Applications
AFpak 6 kinds	Polyhydroxymethacrylate	6 kinds of ligand	Purification of biological molecules depending on biochemical affinity

The Shodex AFpak range of affinity columns consists of 6 different ligand materials, designed for specific applications.

Chiral Separation Phases

Column Series	Base Material	Functional Group	Comments/Applications
ORpak CDA, CDB, CDC	Polyhydroxymethacrylate	Cyclodextrin derivative	Suitable for separation of optical isomers and structural isomers. CDA is α -CD, CDB is β -CD, CDC is γ -CD
ORpak CDBS	Silica	Cyclodextrin derivative	CDBS is β -CD
ORpak CRX	Polyhydroxymethacrylate	L-amino acid derivative	Separation of amino acids by ligand exchange

Shodex ORpak CD phases consist of α -, β - or γ -cyclodextrin bonded to polyhydroxymethacrylate base material or silica (α -cyclodextrin). Shodex ORpak CRX columns have an L-amino acid derivative bonded to polyhydroxymethacrylate and are suitable for the separation of optical isomers of amino acids and hydroxy acids.

Please contact Hichrom for further information on any Shodex column and for ordering information for columns not listed.

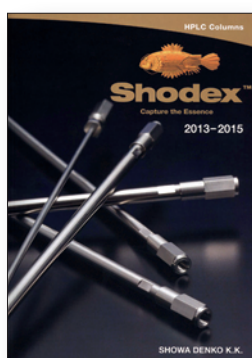

- Novel silica-based mixed-mode phases
- Suitable for RP, NP, ion-exchange and ion-exclusion chromatography
- Unique adjustable selectivity
- Stable in 100% aqueous eluents
- LC-MS and preparative chromatography applications

Primesep® mixed-mode stationary phases have been developed by SIELC Technologies for separating a wide range of polar and non-polar compounds by different separation modes, based only on eluent selection. Ionizable compounds interact with the stationary phase by reversed-phase, ion-exchange or ion-exclusion mechanisms. In addition, Promix™ phases are available for biomolecule analysis. Obelisc™ mixed-mode phases are described on page 147 and the newer SHARC™ columns on page 148. Please see page 3 for Coresep™ (superficially porous) mixed-mode phases.

Primesep® Phases

Primesep Phase	Particle Size (µm)	Pore Size (Å)	Main Separation Modes	Typical Applications
A	5, 10	100	RP + cation-exchange + ion-exclusion	Neutral and weak basic compounds
100	5, 10	100	RP + cation-exchange + ion-exclusion	Neutral and basic compounds
200	5, 10	100	RP + cation-exchange + polar interaction	Neutral and strong basic compounds
500	5, 10	100	RP + cation-exchange + ion-exclusion	Neutral and basic compounds
C	5, 10	100	RP + cation-exchange + complex formation	Amines, sulphonium, phosphonium and metal ions
P	5, 10	100	RP + strong cation-exchange + π - π interaction	Neutral and basic compounds Structural isomers of aromatic compounds
AB	5, 10	100	RP + cation-exchange + anion-exchange	Neutral, acidic and basic compounds
B	5, 10	100	RP + anion-exchange + ion-exclusion	Neutral and acidic compounds
B2	5, 10	100	RP + anion-exchange + ion-exclusion	Neutral and acidic compounds
SB	5, 10	100	RP + anion-exchange + ion-exclusion	Neutral and acidic compounds
D	5, 10	100	RP + anion-exchange	Small hydrophobic and acidic compounds Low MW plasma components and biofluids

Table 1 summarises the retention of polar compounds on Primesep phases compared with typical C18 phases at various eluent pHs.

Table 1. Retention of Polar Compounds

Polar Compounds	Primesep	Typical C18	
		Acidic pH	Basic pH
Basic	Good	Poor	Good
Acidic	Good	Good	Poor
Zwitterionic	Good	Poor	Poor

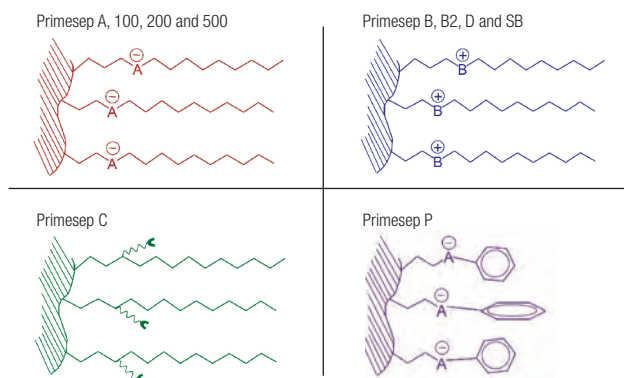

Figure 1. Primesep phases

Each Primesep column has a dual chemistry stationary phase containing a hydrophobic long alkyl chain and an ionisable cationic or anionic embedded group. Reversed-phase and ion-exchange interactions can be controlled independently; reversed-phase by organic concentration and ion-exchange by eluent ionic strength and pH. All columns offer the same hydrophobic retention properties but differ in their ion-exchange and other properties.

Primesep columns are suitable for analytical and preparative scale separations in isocratic and gradient modes, and are compatible with all common detection techniques.

These columns are resistant to dewetting in 100% aqueous eluent and are stable in pure organic and highly acidic conditions down to pH 1.5. They can efficiently separate organic and inorganic ions on the same column at the same time. This enables an organic pharmaceutical to be quantified simultaneously with its inorganic counter ion. Also, inorganic cations and anions can be run together without a specialised ion chromatography system.

The choice of buffer for use with Primesep columns depends on the detection technique. For UV detection, TFA, sulphuric acid, phosphoric acid and their salts are recommended. For LC-MS or ELSD detection, the best choices are TFA, ammonium formate, ammonium acetate, formic and acetic acids.

Primesep® Embedded Acidic Phases

Primesep A, 100, 200 and 500

Primesep® A, 100, 200 and 500 are reversed-phase columns with different strengths of embedded acidic (anionic) ion-pairing groups. Primesep A is the strongest acidic column, while Primesep 500 is the weakest acidic column. Differences in functional group acidity allow selection of the most appropriate column for a particular set of basic compounds that differ in their pKa value.

The embedded acidic functional group can be in an ionised form, or in a non-ionised form, depending on the pH of the eluent. When these two forms (see below) are in equilibrium, the phase is half ionised and half non-ionised. In order to achieve component retention by ion-exchange on these Primesep columns, eluent pH should be close to or above the transition value, as shown below.

Primesep Phase	Transition pH
A	Ionized at all working pH
100	pH 1
200	pH 2
500	pH 5
C	pH 3.5

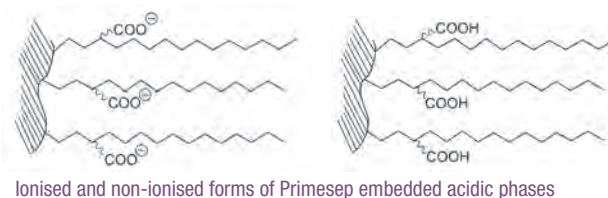

Primesep 100 and 200 are versatile columns for separation of a broad range of compounds. Figure 2 shows the separation of underivatized amino acids on Primesep 100. Figure 3 illustrates the application of Primesep 200 for catecholamines.

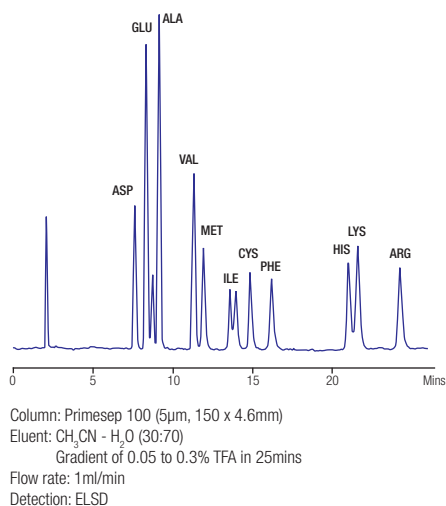

Figure 2. Analysis of amino acids on Primesep 100

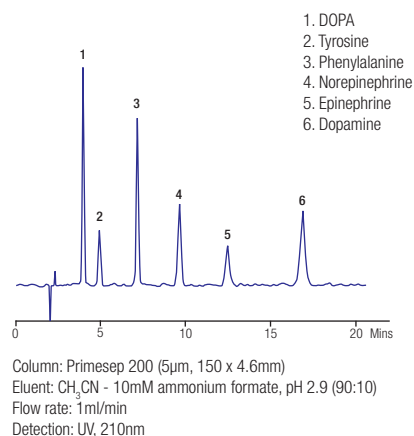

Figure 3. Analysis of catecholamines on Primesep 200

Primesep C

Primesep C also contains an embedded anionic group (carboxylic acid) but with additional complex-formation properties. The latter facilitates retention of amines, sulphonium, phosphonium and metal ions. The degree of ion-exchange and complex formation can be effectively adjusted by the alteration of eluent pH, within the range 3 – 7. The unique complex forming properties of Primesep C columns lead to a reversal of elution order compared to ion-exchange, eg. $t_R Li^+ > Na^+ > K^+$. Similarly primary amines are retained longer than secondary and tertiary amines on Primesep C columns.

Figure 4 shows the analysis of the active ingredients in a cough and cold medicine on Primesep C.

Primesep P

The Primesep P phase provides three interactions with analytes – reversed-phase, π - π interaction and strong cation-exchange. It contains embedded acidic ion-pairing groups combined with an aromatic moiety and is useful for the separation of structural isomers of aromatic compounds. Enhanced π - π interaction can be achieved by adding THF to CH₃CN-H₂O eluents.

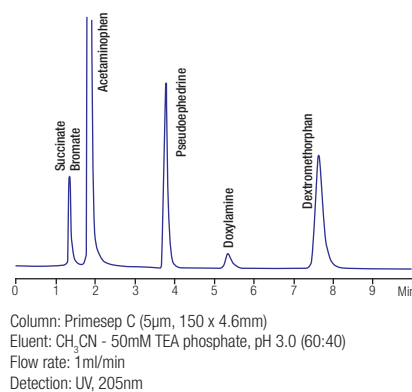

Figure 4. Analysis of active ingredients in cough and cold drugs on Primesep C

Primesep® Embedded Basic Phases

Primesep B, B2 and SB

Primesep® B, B2 and SB contain embedded basic ion-pairing groups. In addition to improving the retention of acidic compounds by anion-exchange, the phases separate bases by an ion exclusion mechanism. Primesep B and SB are strong basic columns for operation in the pH range 1.5 to 4.5 and 1.5 to 5 respectively, created by the addition of TFA, phosphoric or perchloric acids to the eluent. Primesep B2 is a weak basic column that offers an extended pH range from 1.5 to 7, suitable for use with appropriate buffered solutions. For development of new methods, Primesep B2, SB or D are recommended, due to the extended pH stability range. Primesep B, B2, SB and D are fully ionised at all working pH values.

Figure 5 shows the simultaneous separation of dronic acids on Primesep SB.

Primesep D

Primesep D comprises an anion-exchange group embedded in a long alkyl chain. It is a weaker basic column than Primesep B2. In addition, Primesep D allows direct injection of plasma and other biofluids, enabling a broad range of small molecules to be analysed via a single column without any sample preparation. At pH 3.0, most proteins become positively charged and are excluded from the stationary phase, whilst small hydrophobic molecules are retained. Figure 6 illustrates a direct plasma injection on Primesep D.

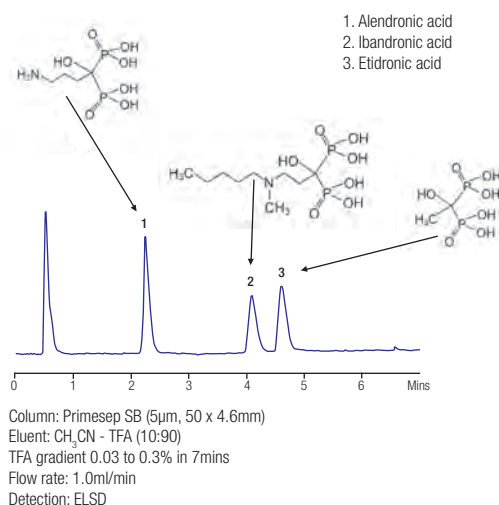

Figure 5. Analysis of dronic acids on Primesep SB

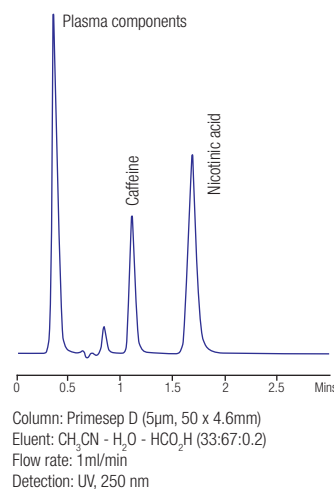

Figure 6. Direct plasma analysis on Primesep D

Embedded Acidic and Basic Phase

Primesep AB

Primesep AB is a zwitterionic reversed-phase column with embedded cation-exchange and anion-exchange functionalities, combining the properties of both in a single column. With basic analytes, Primesep AB behaves as if it has a negatively charged surface. Conversely, with strong acids Primesep AB behaves as if it has a positively charged surface. Anions and cations can be separated at the same time as neutrals. This is useful for complex mixtures which include polar ionisable compounds both of acidic and basic nature. The column is also capable of separating both the anion and cation of the same salt. This is important in analysis of pharmaceutical formulations, drug substances and other organic and inorganic salts.

Figure 7 shows the separation of a mixture of the quaternary compounds diquat and paraquat on Primesep AB.

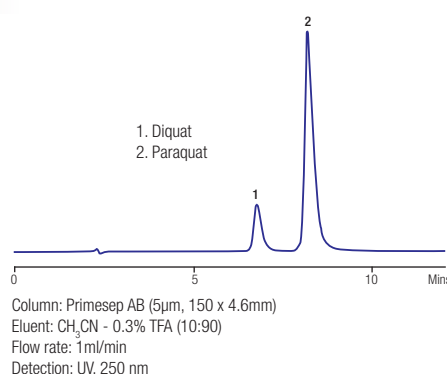

Figure 7. Separation of mixture of diquat and paraquat on Primesep AB

Selectivity of Primesep® Phases

The cation-exchange Primesep phases (A, 100, 200 and P) show greater retention for basic compounds, whereas the anion-exchange Primesep phases (SB, B, D and B2) show the greatest retention for acidic compounds. Table 2 highlights the relative cationic and anionic strengths of the various Primesep phases.

Table 2. Relative Strengths of Primesep Phases

Cation-Exchange		Anion-Exchange
Primesep A	Strong Weak	Primesep SB
Primesep 100, P		Primesep B
Primesep 200		Primesep D
Primesep C		Primesep B2

Ordering Information – Primesep® (5µm, 100Å phases)¹

When ordering please replace 'X' with phase type ie. A, 100, 200, 500, C, B, B2, D, P, AB, SB

Column i.d. ² (mm)	Column Length ² (mm)				Guards ³ (2/pk)
	50	100	150	250	
2.1	X-21.050.0510	X-21.100.0510	X-21.150.0510	X-21.250.0510	X-21.G.0510
3.2	X-32.050.0510	X-32.100.0510	X-32.150.0510	X-32.250.0510	X-32.G.0510
4.6	X-46.050.0510	X-46.100.0510	X-46.150.0510	X-46.250.0510	X-46.G.0510
10	X-100.050.0510	X-100.100.0510	X-100.150.0510	X-100.250.0510	-
22	X-220.050.0510	X-220.100.0510	X-220.150.0510	X-220.250.0510	-
22 (10µm)	X-220.050.1010	X-220.100.1010	X-220.150.1010	X-220.250.1010	-

¹ Other pore sizes and particle sizes available

² Other dimensions available

³ Direct connect - no holder required



Primesep direct connect guard column

Preparative Separations

Primesep® columns offer high capacity ion-exchange mechanisms for the retention of polar compounds. This enables these columns to be successfully used for scale-up separations. Conditions can be developed to be efficient and economical for preparative separations. For example, for ionisable compounds, conditions can be chosen where a high concentration of organic modifier is present, reducing the cost of solvent removal. In addition, the ability to reverse the elution order of differently charged components in the mixture, makes Primesep particularly effective for isolating specific components. Figure 8 demonstrates the high loading capacity of a Primesep 100 analytical column, which infers a high capacity ion-exchange mechanism on scaling up to preparative dimensions.

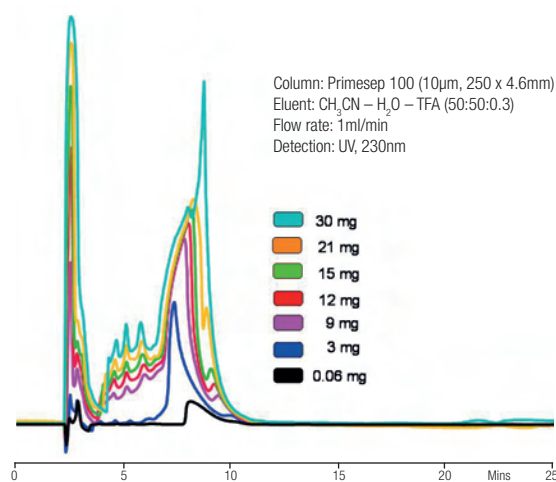

Figure 8. Loading study of HCl salt of polar compound

PROMIX™

- Peptide and protein separations
- 2D HPLC with single column
- Alternative selectivity to reversed-phase 300Å columns
- Scalable from capillary to preparative

Promix Phase	Particle Size (µm)	Pore Size (Å)
SP	5, 10	100
AP	5, 10	100, 300
MP	5, 10	300, 800
LP	5, 10	800

The Promix™ range of columns, manufactured by SIELC, is designed for biomolecule analysis, in particular the analysis and purification of peptides and proteins, and for proteomics applications. Promix columns have the benefit of performing 2D HPLC with a single column, based on a combination of ionic and reversed-phase interactions.

Independent control of acid/buffer concentration and organic modifier offers almost unlimited control of retention and selectivity. Promix columns show enhanced selectivity compared to dedicated reversed-phase or ion-exchange columns for closely related peptides and proteins, being able to separate compounds differing in sequence by a single amino acid pair only. Methods on these columns are completely scalable from capillary to preparative. Figure 9 shows the separation of insulin analogues differing in sequence by a single amino acid pair.

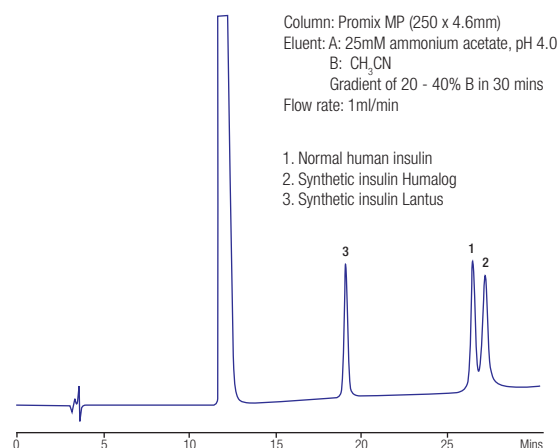

Figure 9. Separation of human and synthetic insulins on Promix

Please contact Hichrom for ordering information for Promix columns.

Obelisc™

- Multiple separation modes
- Simple eluent selection
- MS, ELSD and low UV (<220nm) compatible
- Adjustable selectivity

Obelisc™ HPLC columns are based on a new generation of mixed-mode phases developed by SIELC Technologies. Two complementary columns, Obelisc R and Obelisc N, based on **Liquid Separation Cell (LiSC™)** technology, offer a new approach to separating a variety of small polar and non-polar compounds, by multiple separation mechanisms. Like living cells, which exist in equilibrium with the outside environment, liquid separation cells exist in constant equilibrium with the eluent.

Obelisc R, with reversed-phase characteristics, and Obelisc N, with normal-phase characteristics, differ in the type and proximity of their charged groups and the hydrophobicity of their long linking chains. Obelisc R has cationic groups close to the 100Å silica surface separated from anionic groups by a hydrophobic chain. Obelisc N has anions close to the silica surface separated from cationic groups by a hydrophilic chain.

Typical eluents used with Obelisc columns are based on acetonitrile, water and MS compatible buffers ammonium formate (pH 3) and ammonium acetate (pH 5), or phosphate buffer for low UV detection.

Obelisc R

Specially developed 'AQ' type columns are designed to work in low organic containing eluents, often 100% aqueous, for the analysis of polar compounds by reversed-phase. However, they can often offer insufficient improvement in retention of highly polar molecules. Obelisc R can be used in traditional RP type applications and it offers significant improvement in the degree of retention of both acidic and basic polar molecules, compared with typical 'AQ' type phases.

Obelisc R is recommended for the analysis of complex mixtures of polar and non-polar molecules, especially with MS, ELSD or CAD detection. Figure 10 shows the separation of a complex mixture of acids, bases, amino acids and neutral compounds on Obelisc R.

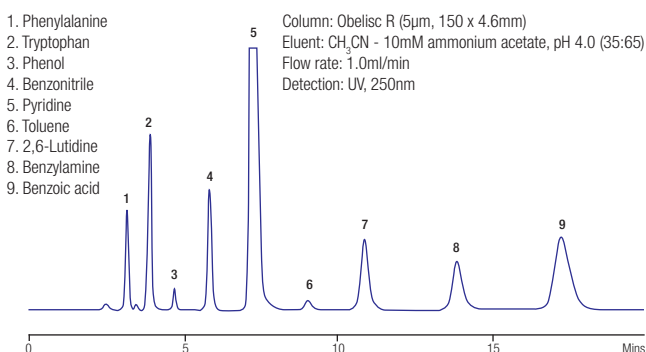

Figure 10. Separation of amino acids, bases, acids and neutrals on Obelisc R

Obelisc N

Obelisc™ N has very polar characteristics and works well for polar and charged analytes. The positive and negative charges of the phase are well separated and independently accessible, which results in different selectivity compared to traditional HILIC and silica columns. Figure 11 shows the HILIC separation of sugars on Obelisc N. Eluent composition changes the conformation of the long hydrophilic chain, thus changing separation selectivity. Figure 12 shows the effect of buffer concentration on the resolution of isomeric aminobutyric acids.

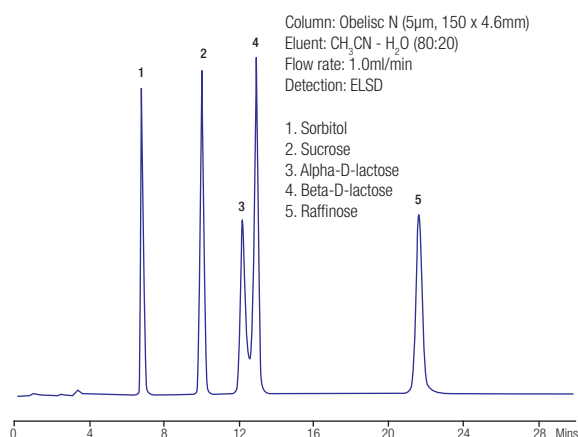

Figure 11. Separation of sugars in HILIC mode on Obelisc N

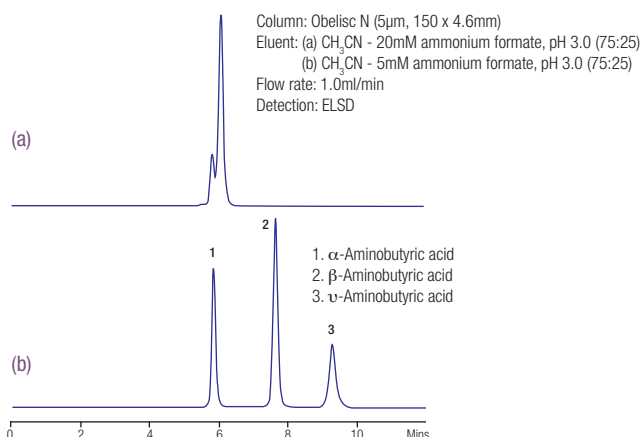

Figure 12. Separation of aminobutyric acids on Obelisc N

Ordering Information (5µm, 100Å phases)¹

When ordering please replace 'X' with OR for Obelisc R or ON for Obelisc N

Column i.d. (mm)	Column Length (mm)				Guards ² (2/pk)
	50	100	150	250	
2.1	X-21.050.0510	X-21.100.0510	X-21.150.0510	X-21.250.0510	X-21.G.0510
3.2	X-32.050.0510	X-32.100.0510	X-32.150.0510	X-32.250.0510	X-32.G.0510
4.6	X-46.050.0510	X-46.100.0510	X-46.150.0510	X-46.250.0510	X-46.G.0510
10	X-100.050.0510	X-100.100.0510	X-100.150.0510	X-100.250.0510	-
22	X-220.050.0510	X-220.100.0510	X-220.150.0510	X-220.250.0510	-

¹ 10µm phase also available

² Direct connect – no holder required

SHARC™

SHARC™ (Specific Hydrogen-bond Adsorption Resolution Chromatography) columns are the latest columns developed by SIELC Technologies. They are the first commercially available columns which provide separations based primarily on hydrogen bonding. SHARC 1 achieves separation based on the analyte's ability to act as a hydrogen atom donor or acceptor.

Operating Conditions

Solvents used for SHARC separations are acetonitrile (MeCN) as the weak solvent and methanol (MeOH) as the strong solvent. Acetonitrile alone has a low level of hydrogen bonding with the SHARC stationary phase, whereas methanol interacts strongly, reducing retention of

analytes capable of hydrogen interactions (Figure 13). By altering the ratio of acetonitrile/methanol, the optimum retention profile can be obtained for many types of molecules.

Analytes can retain on the stationary phase by more than one hydrogen bond and act as a donor or acceptor. The SHARC 1 column is a hydrogen atom acceptor type stationary phase, showing increased retention towards molecules with higher numbers of polar X-H bonds such as alcohols, amines, acids, amides, phenols etc.

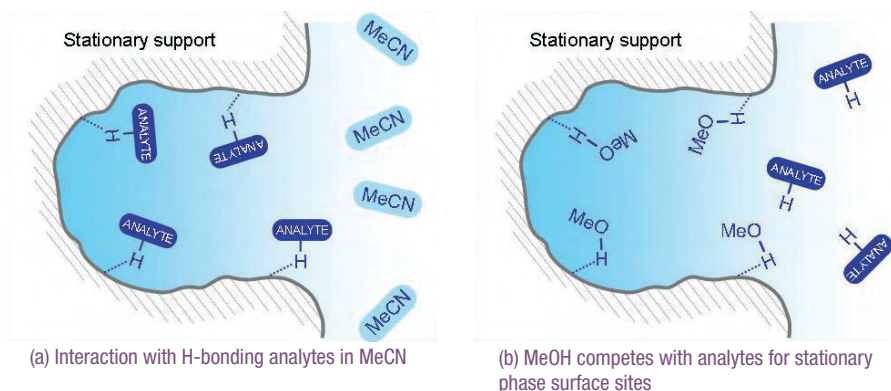

Figure 13. SHARC technology

Benefits of SHARC Columns

- 1) Acetonitrile-methanol mixtures have lower viscosity than aqueous solvent mixtures, enabling the use of smaller particles and faster flow rates, for fast analyses.
- 2) Methanol is one of the most universal solvents for organic compounds.
- 3) Acetonitrile-methanol mixtures have a low boiling point and are much easier to evaporate than water, a benefit for preparative separations.
- 4) Acetonitrile-methanol mixtures are MS friendly, enabling mass directed preparative strategies.
- 5) A wide range of compounds with functional groups containing oxygen and nitrogen can be retained and separated.

Figure 14 shows the separation of a mixture of four neurotransmitters, based on their ability to form hydrogen bonds with the SHARC 1 stationary phase. Elution order corresponds to the number and strength of interaction points.

Column: SHARC 1 (100 x 3.2mm)
 Eluent: (a) CH₃CN – CH₃OH (70:30) with 0.25% formic acid and 0.025% ammonium formate
 (b) CH₃CN – CH₃OH (95:5) with 0.5% formic acid and 0.05% ammonium formate
 Flow rate: 1.0ml/min
 Detection: UV, 270nm

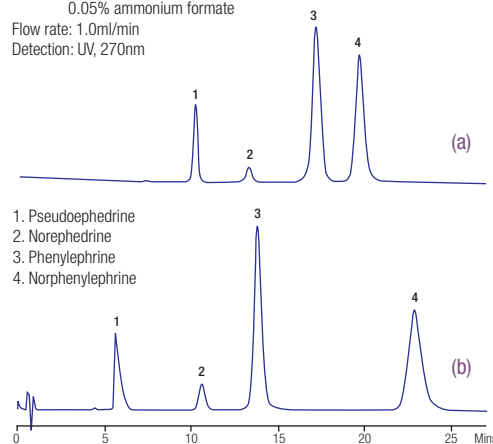

Figure 14. Effect of eluent composition on separation on SHARC 1

Ordering Information – SHARC 1 (5µm, 100Å)

Column i.d. ¹ (mm)	Column Length ¹ (mm)				Guards ² (2/pk)
	50	100	150	250	
2.1	SH1-21.050.0510	SH1-21.100.0510	SH1-21.150.0510	SH1-21.250.0510	SH1-21.G.0510
3.2	SH1-32.050.0510	SH1-32.100.0510	SH1-32.150.0510	SH1-32.250.0510	SH1-32.G.0510
4.6	SH1-46.050.0510	SH1-46.100.0510	SH1-46.150.0510	SH1-46.250.0510	SH1-46.G.0510
10	SH1-100.050.0510	SH1-100.100.0510	SH1-100.150.0510	SH1-100.250.0510	-
22	SH1-220.050.0510	SH1-220.100.0510	SH1-220.150.0510	SH1-220.250.0510	-
22 (10µm)	SH1-220.050.1010	SH1-220.100.1010	SH1-220.150.1010	SH1-220.250.1010	-

¹ Other dimensions available, including capillary² Direct connect - no holder required

In addition to the well-known classical Hypersil® and Hypersil BDS phases (see page 151), Thermo Scientific manufactures a wide range of premium phases, including Hypersil GOLD® (page 150) and Hypercarb® (page 150). Their newest development is the Accucore™ range, based on a core enhanced material. In addition, Acclaim™, ProSwift®, ProPac™ and PepSwift HPLC columns, developed by Dionex, are now sold under the Thermo Scientific brand (see pages 152-153).

Accucore™

Using Core Enhanced Technology™, Accucore HPLC Columns offer higher speed, higher resolution separations compared to traditional larger fully porous particles. They are available in a wide range of selectivities and compatible with almost any instrument.

Accucore HPLC Columns

These solid core particles have an overall diameter of 2.6µm with a porous layer thickness of 0.5µm and a very narrow particle size distribution. Accucore columns offer high speed, high resolution separations with significantly lower back pressures than those associated with UHPLC.

Accucore HPLC Columns for Biomolecules

The range of Accucore columns packed with 150Å pore diameter particles (2.6µm) enables biomolecule separations to benefit from the high resolution and speed provided by Core Enhanced Technology.

Accucore XL HPLC Columns

Using 4µm solid core particles, Accucore XL HPLC columns allow users of conventional HPLC methods to obtain superior performance to that of columns packed with 5, 4 or 3µm fully porous particles.

The key components of Core Enhanced Technology

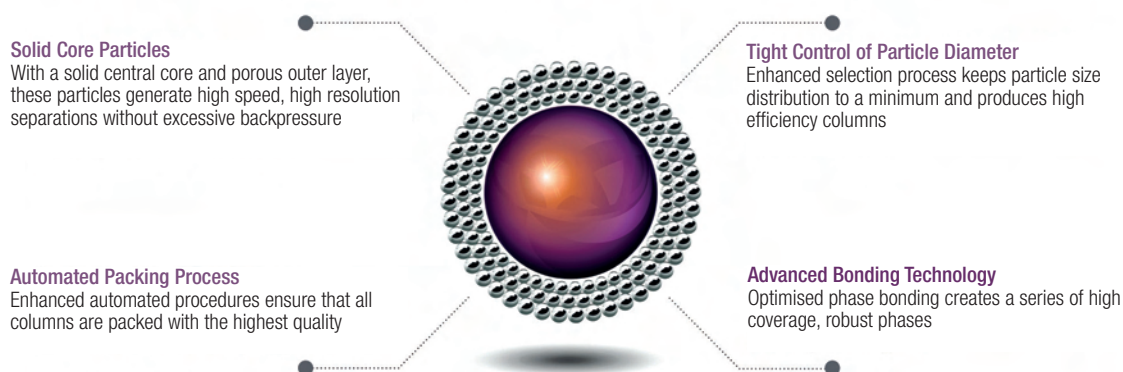

Accucore Phases

Column	Phase	Bonding	Particle Size (µm)	Pore Size (Å)	Surface Area (m ² /g)	Carbon Load (%)	pH Range
Accucore HPLC Columns	RP-MS	Proprietary	2.6	80	130	7	2 - 9
	C18	C18	2.6	80	130	9	1 - 11
	C8	C8	2.6	80	130	5	2 - 9
	aQ	C18 with polar endcapping	2.6	80	130	9	2 - 9
	Polar Premium	Amide embedded C18	2.6	150	80	8	1.5 - 10
	Phenyl-Hexyl	Phenyl-Hexyl	2.6	80	130	5	2 - 8
	PFP	Pentafluorophenyl	2.6	80	130	5	2 - 8
	Phenyl-X	Proprietary	2.6	80	130	6	2 - 8
	C30	C30	2.6	150	80	5	2 - 8
	HILIC	-	2.6	80	130	-	2 - 8
Urea-HILIC	Urea	2.6	80	130	-	2 - 8	
Accucore Columns for Biomolecules	150-C18	C18	2.6	150	80	7	1 - 11
	150-C4	C4	2.6	150	80	2	2 - 9
	150-Amide-HILIC	Amide	2.6	150	80	-	2 - 8
Accucore XL HPLC Columns	C18	C18	4	80	90	7	1 - 11
	C8	C8	4	80	90	4	2 - 9

Please contact us for ordering information on all Accucore columns.

Hypersil GOLD®

Hypersil GOLD® columns are based on high purity silica and a novel proprietary derivatization and endcapping procedure, which reduces unwanted secondary and tertiary interactions of an analyte with the silica. The range includes a number of different bonding chemistries. Columns can be supplied in a wide range of particle sizes (1.9 to 12µm) and in column dimensions from capillary to preparative. Hypersil GOLD, Hypersil GOLD aQ and Hypersil GOLD PFP are also available in nanobore formats for nanospray LC-MS applications, particularly proteomics.

Hypersil GOLD Phases

Phase	Functional Group	Endcapped	Particle Size (µm)	Pore Size (Å)	Surface Area (m ² /g)	Carbon Load (%)	pH Range
GOLD	Proprietary	Yes	1.9, 3, 5, 8, 12	175	220	10	1 - 11
GOLD C8	Octyl	Yes	1.9, 3, 5	175	220	8	2 - 9
GOLD C4	Butyl	Yes	1.9, 3, 5	175	220	5	2 - 8
GOLD aQ	Octadecyl	Yes	1.9, 3, 5, 8, 12	175	220	12	2 - 9
GOLD PFP	Perfluorophenyl	Yes	1.9, 3, 5, 8, 12	175	220	8	2 - 8
GOLD CN	Cyano	Yes	1.9, 3, 5	175	220	4	2 - 8
GOLD Phenyl	Phenyl	Yes	1.9, 3, 5	175	220	8	2 - 8
GOLD Amino	Amino	Yes	1.9, 3, 5	175	220	2	2 - 8
GOLD AX	Polymeric amine	No	1.9, 3, 5	175	220	6	2 - 8
GOLD SAX	Quaternary amine	Yes	1.9, 3, 5	175	220	2.5	2 - 8
GOLD Silica	-	-	1.9, 3, 5	175	220	-	2 - 8
GOLD HILIC	Polyethyleneimine	n/a	1.9, 3, 5	175	220	6	2 - 8

Hypersil GOLD Selectivities

In addition to the original **Hypersil GOLD** phase, eleven other phases are now available, offering a range of selectivity options to optimise separations and maximise productivity. The original Hypersil GOLD shows C18-like USP L1 retention and selectivity. The phase is claimed to be stable over the pH range 1 to 11.

Hypersil GOLD C4 columns provide similar selectivity to C18 and C8 columns but with less retention. The shorter chain length and lower hydrophobic character make C4 a particularly useful phase for separation of hydrophobic polypeptides and small proteins.

Hypersil GOLD aQ is a polar endcapped C18 phase, which is compatible with highly aqueous eluents. It offers superior retention of polar compounds, due to the polar functional group providing additional interaction mechanisms with polar compounds.

Hypersil GOLD PFP columns offer alternative selectivity in reversed-phase HPLC by offering extra retention and selectivity for positional isomers of halogenated compounds. They are also well suited for the selective analysis of non-halogenated compounds, particularly polar compounds containing hydroxyl, carboxyl, nitro or other polar groups, especially when these groups are located on an aromatic or other rigid ring system.

Hypersil GOLD Amino can be used as a weak anion-exchange material for the analysis of anions and organic acids. It is also useful for carbohydrate analysis when used in reversed-phase or HILIC mode.

Hypersil GOLD AX columns utilise a novel polymeric amine ligand bonded to silica. It is a weak anion-exchange material, suitable for the analysis of smaller proteins and peptides and anionic species. They are particularly suited to the analysis of polar compounds in HILIC applications.

Hypersil GOLD SAX is a highly stable silica-based quaternary amine strong anion-exchange phase. Columns are suited to the analysis of smaller organic molecules such as nucleotides and organic acids.

Please contact us for ordering information on Hypersil GOLD columns.

Hypercarb®

Hypercarb® is a unique **Porous Graphitic Carbon (PGC)** phase composed of flat sheets of hexagonally arranged carbon atoms, with a fully satisfied valence. The selectivity offered by Hypercarb is different to that of silica and polymeric phases. Hypercarb is ideally suited to the separation of highly polar compounds and compounds with closely related structures, including geometric isomers and diastereomers.

The physical characteristics of the material are different from conventional silica and polymer materials. Hypercarb is totally stable across the entire pH range. It can be used for both normal- and reversed-phase HPLC and is well suited for reversed-phase LC-MS assays as it is stable with any eluent and produces no phase bleed issues. Hypercarb is ideal for high temperature applications and the robust nature of the material ensures a long column lifetime.

Particle Size (µm)	Pore Size (Å)	Pore Volume (cc/g)	Surface Area (m ² /g)
3, 5, 7	250	0.7	120

Please contact us for ordering information on Hypercarb columns.

Hypersil®

Hypersil® is a traditional 120Å pore size silica, manufactured by Thermo Scientific. The octyl-, cyano- and phenyl-bonded phases are available as both endcapped and non-endcapped materials.

Hypersil Phases¹

Hypersil Phase	Functional Group	Endcapped	Particle Size (µm)	Pore Size (Å)	Surface Area (m ² /g)	Carbon Load (%)
Silica	-	No	3, 5	120	170	-
SAS (C1)	Methyl	No	5	120	170	2.5
MOS (C8)	Octyl	No	3, 5	120	170	6.5
MOS-2 (C8)	Octyl	Yes	5	120	170	6.5
ODS (C18)	Octadecyl	Yes	3, 5	120	170	10
ODS-2 (C18)	Octadecyl	Yes	3, 5	80	220	11
Phenyl	Phenyl	No	5	120	170	5
Phenyl-2	Phenyl	Yes	5	120	170	5
CPS (CN)	Cyano	No	3, 5	120	170	4
CPS-2 (CN)	Cyano	Yes	5	120	170	4
APS-2 (NH ₂)	Amino	No	3, 5	120	170	2

¹ Please contact us for ordering information on Hypersil columns.

Hypersil® BDS

Hypersil® BDS is base deactivated to remove the active silanols and present a homogeneous surface for bonding, resulting in improved peak shape and column performance. Hypersil BDS is available in C8, C18, phenyl and cyano phases.

Hypersil BDS Phases¹

Hypersil BDS Phase	Particle Size (µm)	Pore Size (Å)	Pore Volume (cc/g)	Surface Area (m ² /g)	Carbon Load (%)
BDS C8	2.4, 3, 5	130	0.65	170	7
BDS C18	2.4, 3, 5	130	0.65	170	11
BDS Phenyl	3, 5	130	0.65	170	5
BDS Cyano (CPS)	3, 5	130	0.65	170	4

¹ Please contact us for ordering information on Hypersil BDS columns.

Synchronis™

Synchronis™ HPLC columns are based on high purity 100Å silica, with a surface area of 320m²/g. Phases are available in three particle sizes: 1.7µm for rapid UHPLC separations and 3µm and 5µm for more traditional HPLC analyses. Synchronis reversed-phase columns are densely bonded and double endcapped to minimise the number of interacting silanols.

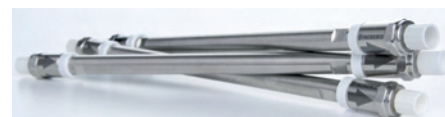

Synchronis Phases¹

Synchronis Phase	Endcapped	Particle Size (µm)	Pore Size (Å)	Surface Area (m ² /g)	Carbon Load (%)	pH Range
C18	Yes	1.7, 3, 5	100	320	16	2 - 9
C8	Yes	1.7, 3, 5	100	320	10	2 - 8
aQ	Polar	1.7, 3, 5	100	320	19	2 - 8
Phenyl	Yes	1.7, 3, 5	100	320	11	2 - 8
Amino	Yes	1.7, 3, 5	100	320	4	2 - 8
Silica	-	1.7, 3, 5	100	320	-	2 - 8
HILIC	-	1.7, 3, 5	100	320	5	2 - 8

¹ Please contact us for ordering information on Synchronis columns.

Fluophase®

Fluophase® RP (100Å) and WP (300Å) are straight chain perfluorohexyl materials, whereas Fluophase PFP is a perfluorophenyl phase. These fluorinated phases exhibit extra retention and selectivity for halogenated compounds compared with C18 phases. They also exhibit good shape selectivity for positional isomers of halogenated aromatic compounds. Polar compounds are often well retained on these materials. Fluophase phases are also excellent for the separation of difficult non-polar samples such as surfactants. They are frequently used in the analysis of complex taxane samples. Fluophase columns are stable under 100% aqueous conditions, so are ideal for 0 to 100% organic fast gradients.

Please contact us for ordering information on all Hypersil, Hypersil BDS, Synchronis and Fluophase columns.

Acclaim™

Acclaim™ HPLC phases are based on high purity, porous silica particles (2.2, 3 and 5µm), with advanced and innovative column bonding technologies. This provides complementary selectivity, high column efficiencies and symmetrical peaks. Columns for reversed-phase, HILIC, mixed-mode and application specific analyses are available.

Acclaim Reversed-Phase and HILIC Phases¹

Acclaim Phase	Chemistry	Endcapped	Particle Size (µm)	Pore Size (Å)	Surface Area (m ² /g)	Carbon Load (%)	pH Range
120 C18	C18	Yes	2.2, 3, 5	120	300	18	2 - 8
300 C18	C18	Yes	3	300	100	8	2.5 - 7.5
C8	C8	Yes	2.2, 3, 5	120	300	11	2 - 8
C30	C30	Yes	3, 5	200	200	13	2 - 8
Phenyl-1	Alkyl aromatic	Yes	3	120	300	13	2 - 8
PolarAdvantage	Embedded sulphonamide	Yes	2.2, 3, 5	120	300	16	2 - 8
PolarAdvantage II	Embedded amide	Yes	2.2, 3, 5	120	300	16	1.5 - 10.5
HILIC-10	Proprietary	No	3	120	300	8	2 - 8

¹ Please contact us for ordering information on Acclaim reversed-phase and HILIC columns.

Acclaim PolarAdvantage (PA) features a patented bonding chemistry that incorporates a polar sulphonamide group with an ether linkage near the silica surface. Acclaim PA columns are compatible with 100% aqueous eluents and offer unique selectivity and good peak shape for acidic, basic and neutral analytes.

Acclaim PolarAdvantage II (PA2) columns feature a patented surface chemistry that incorporates an amide-embedded polar group and multi-point attachment between the ligands and silica surface. This unique chemistry provides enhanced hydrolytic stability from pH 1.5 to 10.5 with 100% aqueous eluents. Acclaim PA2 is specifically designed to withstand high pH conditions, making it a good choice for the separation of both basic and acidic analytes.

Acclaim™ Mixed-Mode Phases

Mixed-mode columns provide a unique, adjustable selectivity tool, using variation in pH, ionic strength or organic modifier to influence the separation selectivity of acids, bases, zwitterions and neutral molecules.

Acclaim Mixed-Mode Phases¹

Acclaim Phase	Retention Mechanism	Particle Size (µm)	Pore Size (Å)	Surface Area (m ² /g)	pH Range
Mixed-Mode WAX-1	RP + WAX + cation exclusion + HILIC	3, 5	120	300	2.5 - 7.5
Mixed-Mode WCX-1	RP + WCX + HILIC	3, 5	120	300	2.5 - 7.5
Mixed-Mode HILIC-1	RP + HILIC	3, 5	120	300	2.5 - 7.5
Trinity P1	SCX + WAX + RP	3	300	100	2.5 - 7.0

¹ Please contact us for ordering information on Acclaim mixed-mode phases.

Acclaim Mixed-Mode WAX-1 has a surface consisting of a hydrophobic alkyl chain with a tertiary amine group at the terminus. The hydrophobic moiety provides reversed-phase retention and the terminal amino group facilitates electrostatic interactions.

Acclaim Mixed-Mode WCX-1 can separate compounds using multiple separation modes: reversed-phase, cation-exchange and HILIC, and is ideal for the separation of basic molecules. Selectivity can be adjusted by modifying ionic strength, pH or organic solvent composition.

Acclaim Mixed-Mode HILIC-1 combines both reversed-phase and HILIC properties. The phase consists of a hydrophobic alkyl chain with a diol group at the terminus.

Acclaim Trinity P1 is a trimodal phase consisting of high purity porous 3µm silica particles coated with charged nanopolymer beads. The phase retains both cations and anions at the same time, meaning that baseline separation can be achieved for both a drug and its counterions.

Acclaim™ Application Specific Phases

Thermo Scientific Acclaim speciality phases are based on novel and unique chemistries and combine superior resolution with ease of use.

Acclaim Application Specific Phases¹

Acclaim Phase	Particle Size (µm)	Pore Size (Å)	pH Range	Typical Applications
Organic Acid (OA)	3, 5	120	2 - 8	Hydrophilic, aliphatic and aromatic organic acids
Surfactant	3, 5	120	2.5 - 7.5	Anionic, cationic, non-ionic and amphoteric surfactants
Explosives E1	5	120	3 - 7	Nitroaromatic and nitramine explosives
Explosives E2	2.2, 3, 5	120	2.5 - 8	
Carbamate	3, 5	120	2 - 8	Carbamate pesticides
Carbonyl	2.2	120	2.5 - 8	DNPH derivatives of aldehydes and ketones

¹ Please contact us for ordering information on Acclaim application specific columns.

Thermo Scientific Columns for Biomolecules

Thermo Scientific manufacture a wide range of silica and polymeric columns specifically designed for analysis of proteins, peptides, oligonucleotides and other biomolecules by reversed-phase, ion-exchange, size exclusion, hydrophobic interaction and affinity chromatography.

Columns for Proteins

A) Reversed-Phase Columns

BioBasic™ 300Å pore size reversed-phase columns are available in C18, C8 and C4 chemistries. The extra dense bonding produces a highly stable, reproducible surface, ideally suited for LC-MS separations.

ProSwift® RP phenyl bonded polystyrene-divinylbenzene monolith columns provide high resolution at exceptionally high flow rates for fast protein separations and analysis.

B) Ion-Exchange Columns

BioBasic™ AX and SCX wide pore silica-based ion-exchange materials can be used across a wide range of pH and ionic strength conditions. BioBasic AX can also be used under high organic conditions in the HILIC mode.

ProPac™ and MAbPac phases are based on pellicular, non-porous core particles. They provide high resolution and efficiency for separations of protein variants, resolving isoforms that differ by a single charged residue. The ProPac series is based on non-porous polymer resin consisting of ethylvinylbenzene cross-linked with 55% divinylbenzene coated with a hydrophilic layer.

ProSwift® IEX polymethacrylate monolithic columns provide the resolving power of non-porous analytical media combined with fast analysis performance. WCX, SCX, WAX and SAX chemistries are available.

C) Size Exclusion Columns

BioBasic™ SEC columns, based on silica with a proprietary polymeric coating, offer the mechanical stability of silica size exclusion columns, with higher efficiencies than that of polymer-based columns. Four pore sizes are available (60Å, 120Å, 300Å and 1000Å).

MAbPac SEC-1 (300Å, 5µm diol-bonded silica) is a size exclusion column specifically designed for separation and characterisation of monoclonal antibodies and their aggregates, as well as the analysis of Fab and Fc fragments resulting from proteolysis.

D) Hydrophobic Interaction Columns

The **ProPac HIC-10** column is a high resolution, high capacity, 300Å, 5µm silica based HIC column for the high resolution separations of proteins and protein variants.

E) Affinity Columns

ProPac IMAC-10 is a high resolution column for separation of proteins and peptides by immobilised metal affinity chromatography. It is packed with 10µm non-porous polymeric beads coated with a hydrophilic layer, then grafted with poly(iminodiacetic acid) chains.

ProSwift® ConA-1S affinity monolith column is designed for the efficient enrichment and purification of Concanavalin A binding glycans, glycopeptides and glycoproteins. It shows high capacity and high sample recovery.

Columns for Oligonucleotides

Thermo Scientific offer DNAPac® pellicular anion-exchange resins and DNA Swift™ polymeric monolithic phase specifically for the analysis of oligonucleotides.

DNAPac® PA100 and PA200 are strong anion-exchange columns developed to provide high resolution analysis and purification of synthetic oligonucleotides. They are capable of resolving full length from n-1, n+1 and other failure sequences.

DNASwift™ SAX-1S is a strong porous anion-exchange monolithic column that provides exceptionally high purity and yield of oligonucleotides. It is compatible with high pH eluents and high temperatures and has a high sample capacity.

Columns for Proteomics

Acclaim™ PepMap has become the standard for peptide separations in proteomics and can be used with all modern nano LC systems. The 2µm Acclaim PepMap RSLC phase has been developed for ultra-high resolution analyses of tryptic, natural and synthetic peptides. Acclaim PepMap Trap columns are typically applied for the desalting of peptides before LC separation with MS detection, thus allowing fast sample preconcentration.

PepSwift and ProSwift – PepSwift (100, 200 or 500µm i.d.) and ProSwift RP-10R (1.0mm i.d.) polystyrene-divinylbenzene monolithic columns show high sensitivity for LC-MS and are ideal for high speed peptide and protein separations.

Columns for Glycans

GlycanPac™ AXH-1 (1.9 and 3µm) is a silica-based column for simultaneous separation of glycans by charge, size and polarity. The column is based on innovative mixed-mode surface chemistry, specifically designed for qualitative, structural analysis and characterisation of uncharged and charged glycans present on proteins.

Please contact us for ordering information on all Thermo Scientific columns for biomolecules.

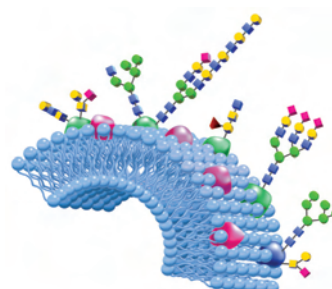

Tosoh Bioscience is a major supplier of liquid chromatography products in the pharmaceutical and biotechnology industries, for the analysis, isolation and purification of proteins, peptides, oligonucleotides and enzymes as well as low molecular weight compounds. TSKgel® is the most popular of several ranges of columns and bulk packing materials supplied by Tosoh Bioscience. An extensive range of products is offered for size exclusion, ion-exchange, reversed-phase, HILIC, HIC and affinity separation techniques.

Size Exclusion Chromatography Phases

TSKgel® columns are available for both modes of size exclusion chromatography (SEC) – gel filtration chromatography (GFC) of water soluble polymers in aqueous eluents and gel permeation chromatography (GPC) of organic soluble polymers using non-aqueous eluents. The TSKgel SW and PW column lines are suitable for GFC, the H-type columns for GPC and the Alpha and SuperAW series can be used for both GFC and GPC.

A. Silica-based Phases (SW)

TSKgel SW and SW_{XL} columns are widely used for aqueous separations of proteins, antibodies, enzymes, nucleic acids and other biological macromolecules. SEC phases with pore sizes of 125, 250 and 450Å enable the analysis of a wide range of molecular weight biomolecules. The smaller particle sizes of the SW_{XL} columns result in reduced analysis times. All SW-type columns are available in stainless steel hardware; SW_{XL} columns are also available in PEEK hardware. TSKgel G3000SW_{XL} is the ideal scouting column for unknown molecular weight compounds.

The **SuperSW** materials (4µm) provide fast, high efficiency separations. The increased sensitivity compared with the corresponding SW_{XL} or SW phase is especially useful for limited sample quantities.

B. Polymer-based Phases (PW)

Polymeric **TSKgel PW and PW_{XL}** series columns are designed for GFC of water soluble organic polymers, polysaccharides, oligosaccharides, DNA and RNA. They are based on a hydrophilic polymethacrylate matrix, which is stable from pH 2 to 12 and in aqueous eluents with up to 50% polar organic solvent.

TSKgel PW_{XL}-CP columns are designed to facilitate the separation of water soluble cationic polymers by SEC.

TSKgel SuperMultiporePW columns are packed with monodisperse polymethacrylate particles, each containing a wide range of pore sizes to cover different molecular weight ranges (see Figure 1). Multi-pore particle technology is the best way to achieve near linear SEC calibration curves.

TSKgel Alpha and SuperAW series columns are based on a hydrophilic, highly cross-linked vinyl polymer resin. These materials are mechanically stable and exhibit minimal swelling and shrinkage. They are suitable for both GFC and GPC.

TSKgel H-type columns are based on porous, highly cross-linked, spherical polystyrene-divinylbenzene resin. These materials are available in 8 pore sizes and various particle sizes, and are compatible with non-polar organic solvents.

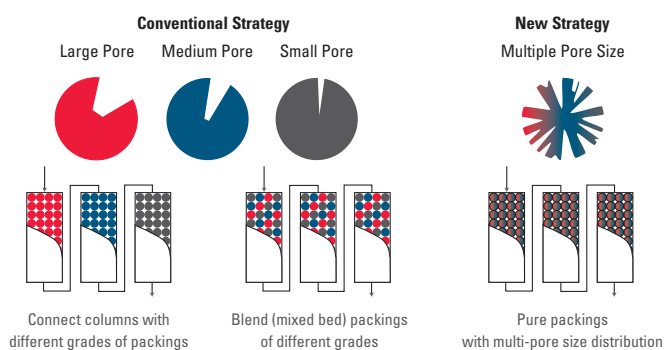

Figure 1. Strategy for wide range separation using SEC

Reversed Phase Materials

Tosoh Bioscience offers a number of both silica- and polymer-based columns for reversed-phase applications.

Silica-based Phases

TSKgel ODS-140HTP is a 2.3µm polymerically bonded C18 phase for high throughput applications.

TSKgel ODS-100V and **ODS-100Z** have a high surface area, with the ODS-100Z phase having higher density bonding. TSKgel ODS-100V is stable in 100% aqueous eluents.

TSKgel Super Series (2.3µm particle size) comprises Super-ODS, Super-Octyl and Super-Phenyl phases, which are polymerically bonded and exhaustively endcapped.

TSKgel Protein C4-300 is a 300Å pore size phase, designed for optimal recovery and resolution of proteins such as recombinant proteins, antibody fragments or PEGylated proteins.

Polymer-based Phases

The polymer-based phases are chemically stable from pH 2 – 12. TSKgel Octadecyl-4PW is suitable for the analysis of peptides and small proteins, whereas TSKgel Octadecyl-2PW is used for small pharmaceutical compounds at basic pH. TSKgel Phenyl-5PW has a high loading capacity and is ideal for the separation of high molecular weight proteins. Non-porous Octadecyl-NPR produces extremely fast kinetics and quantitative recovery of proteins.

Hydrophobic Interaction (HIC) Phases

TSKgel® Phenyl-5PW and Ether-5PW are based on the porous G5000PW resin. The Ether-5PW phase is less hydrophobic than Phenyl-5PW and therefore less retentive. TSKgel Butyl-NPR is based on 2.5µm non-porous particles of the same chemical composition as G5000PW. It is more hydrophobic than Phenyl-5PW and also benefits from excellent mass recovery and is the preferred choice for process monitoring and quality control.

Hydrophilic Interaction (HILIC) Phases

Tosoh Bioscience manufactures two phases for HILIC.

TSKgel® Amide-80 consists of spherical silica particles (3 or 5µm) that are covalently bonded with non-ionic carbamoyl groups. Target applications include hydrophilic biomolecules, including saccharides, glycans, oligosaccharides, peptides, nucleic acids and small molecules for drug discovery.

TSKgel NH2-100 (3µm) is an amino bonded phase with high ligand density and large surface area. It shows good retention for very polar compounds, including carbohydrates, peptides, vitamins and polar drugs.

Structure of TSKgel Amide-80

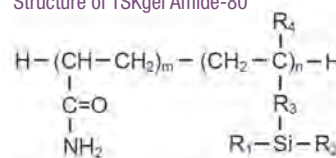

Ion-Exchange Phases

Tosoh Bioscience offers a range of silica and methacrylate based high efficiency columns for analysis and isolation of biomolecules by anion and cation exchange chromatography. The BioAssist materials were created to provide higher capacity for larger proteins and have biocompatible PEEK hardware.

Silica-based (SW) materials have a smaller pore size (125 or 250Å) compared to the polymer-based phases, and are most suitable for analysing smaller molecular weight samples such as nucleotides, pharmaceuticals, catecholamines and small peptides.

Polymer-based (PW) phases are based on porous methacrylate resin (10µm, 1000Å) derived from G5000PW, derivatised with DEAE, SP or CM functionalities.

TSKgel STAT columns are based on monodisperse, non-porous polymethacrylate resin particles, the surface of which consists of an open access network of multi-layered anion- or cation-exchange groups. The innovative bonding chemistry, combined with a relatively large particle size, results in a high loading capacity and a low operating pressure, compared with traditional non-porous resins.

Four phases are available: TSKgel Q-STAT and DNA-STAT (triethylamino bonding), CM-STAT (carboxymethyl bonding) and SP-STAT (sulphopropyl bonding).

Affinity Chromatography Phases

TSKgel affinity columns are based on G5000PW (5PW) porous resin and offer a high level of specificity and selectivity. Process scale media, based on TOYOPEARL HW-65 resin made by the same polymer chemistry, enable easy scale-up. Three affinity phases are available – Boronate-5PW, Chelate-5PW and Tressyl-5PW.

Bulk Resins

Tosoh Bioscience offers a comprehensive range of media for all common modes of liquid chromatography.

TOYOPEARL resins are hydrophilic, macroporous methacrylate-based media for large-scale medium pressure liquid chromatographic applications. They exhibit high mechanical and chemical stability and are stable from pH 2 – 12 for normal operating conditions and pH 1 – 13 for cleaning conditions. The resins are available in average particle sizes of 35, 65, 75 and 100µm for ion-exchange, SEC, HIC and affinity applications.

TOYOPEARL AF Protein A-650F is an affinity resin designed for efficient and robust large-scale purification of monoclonal antibodies.

TSKgel PW resins are larger particle size versions (20 and 30µm) of the methacrylate packing materials used for ion-exchange and hydrophobic interaction chromatography columns.

ToyoScreen® Process Development Columns

ToyoScreen columns are prepacked 1ml and 5ml cartridge design columns for short scouting runs and small scale purification. They are a convenient means of performing early resin screening for both target retention and recovery. They can be connected easily to AKTA®, FPLC and HPLC systems. All ToyoScreen columns are packed with TOYOPEARL materials which are also readily available as bulk polymeric media for scale-up and production.



- Acquired by Hichrom from Beckman Coulter
- High reproducibility
- Optimal surface coverage for long column lifetime
- Narrow particle size distribution for high efficiency and improved resolution
- Widely referenced silica



Hichrom acquired the Ultrasphere® HPLC column range from Beckman Coulter, and manufacture the complete range of Ultrasphere columns and media to the same exacting manufacturing protocols and to identical specifications previously used by Beckman Coulter. Part numbers also remain unaffected by this acquisition.

Ultrasphere Phases

Ultrasphere Phase	Particle Size (µm)	Pore Size (Å)	Endcapped
ODS (C18)	3,5	80	Yes
Octyl (C8)	3,5	80	Yes
Cyano (CN)	3,5	80	No
Silica (Si)	3,5	80	n/a
Ion Pair (IP)	5	80	Yes

Ultrasphere columns are available in five phases with a 5µm particle size – ODS (C18), Octyl (C8), Cyano (CN), Ion Pair (IP) and unbonded silica (Si). Additionally, ODS, Octyl, Cyano and unbonded silica chemistries are available with a 3µm particle size.

Ultrasphere columns remain widely referenced within both industry and academia and are recognised to provide excellent chromatographic performance.

Columns are available in a wide range of dimensions, including microbore (2.0mm i.d.), analytical (4.6mm i.d.) and semi-preparative (10mm i.d.) options. Please contact Hichrom to request availability of any column dimension not listed.



Ultrasphere-XL High Speed Cartridge Columns

In this cartridge design, the guard connects directly to the cartridge column with an integral holder. This integral design (see Figure 1) minimises the dead volume between guard and cartridge column, resulting in high efficiency columns. Please note that the cartridge and guard hardware detailed in Figure 1 are not compatible with the previous hardware design.



Figure 1. Ultrasphere-XL cartridge hardware

Ordering Information – Ultrasphere®

5µm Analytical Columns

Catalogue No.	Description
235329	Ultrasphere 5µm ODS column, 250 x 4.6mm
235330	Ultrasphere 5µm ODS column, 150 x 4.6mm
243533	Ultrasphere 5µm ODS pre-column, 45 x 4.6mm
235332	Ultrasphere 5µm Octyl column, 250 x 4.6mm
235333	Ultrasphere 5µm Octyl column, 150 x 4.6mm
243532	Ultrasphere 5µm Octyl pre-column, 45 x 4.6mm
244071	Ultrasphere 5µm Cyano column, 250 x 4.6mm
244070	Ultrasphere 5µm Cyano column, 150 x 4.6mm
244072	Ultrasphere 5µm Cyano pre-column, 45 x 4.6mm
235341	Ultrasphere 5µm Si column, 250 x 4.6mm
235342	Ultrasphere 5µm Si column, 150 x 4.6mm
244011	Ultrasphere 5µm Si pre-column, 45 x 4.6mm
235335	Ultrasphere 5µm IP column, 250 x 4.6mm
235334	Ultrasphere 5µm IP column, 150 x 4.6mm
243534	Ultrasphere 5µm IP pre-column, 45 x 4.6mm
240002	Ultrasphere 5µm ODS-DABS column, 250 x 4.6mm

5µm Micro Columns

Catalogue No.	Description
244434	Ultrasphere 5µm ODS column, 250 x 2.0mm
237390	Ultrasphere 5µm ODS column, 150 x 2.0mm
237396	Ultrasphere 5µm Octyl column, 250 x 2.0mm
237395	Ultrasphere 5µm Octyl column, 150 x 2.0mm
237394	Ultrasphere 5µm Cyano column, 250 x 2.0mm
237393	Ultrasphere 5µm Cyano column, 150 x 2.0mm
237392	Ultrasphere 5µm Si column, 250 x 2.0mm
237391	Ultrasphere 5µm Si column, 150 x 2.0mm

5µm Semi-Prep Columns

Catalogue No.	Description
235328	Ultrasphere 5µm ODS column, 250 x 10mm
244046	Ultrasphere 5µm ODS column, 150 x 10mm
235331	Ultrasphere 5µm Octyl column, 250 x 10mm
244048	Ultrasphere 5µm Octyl column, 150 x 10mm
244073	Ultrasphere 5µm Cyano column, 250 x 10mm
235340	Ultrasphere 5µm Si column, 250 x 10mm

3µm Analytical Columns

Catalogue No.	Description
244254	Ultrasphere 3µm ODS High Speed Column, 75 x 4.6mm
244228	Ultrasphere 3µm Octyl High Speed Column, 75 x 4.6mm
237573	Ultrasphere 3µm Cyano High Speed Column, 75 x 4.6mm
237574	Ultrasphere 3µm Si High Speed Column, 75 x 4.6mm

3µm XL Cartridge Columns

Catalogue No.	Description
238370	Ultrasphere-XL 3µm ODS Starter Set; contains 1 x Cartridge Column (70 x 4.6mm), 2 x guard cartridges, 1 x holder
237500	Ultrasphere-XL 3µm ODS Cartridge Column, 70 x 4.6mm
237520	Ultrasphere-XL 3µm ODS Guard Cartridge (5mm length, 2/pk)
238371	Ultrasphere-XL 3µm Octyl Starter Set; contains 1 x Cartridge Column (70 x 4.6mm), 2 x guard cartridges, 1 x holder
237501	Ultrasphere-XL 3µm Octyl Cartridge Column, 70 x 4.6mm
237521	Ultrasphere-XL 3µm Octyl Guard Cartridge (5mm length, 2/pk)
237060	Ultrasphere-XL Column Holder Assembly

Accessories

Catalogue No.	Description
250001	Column – Pre-column Connector Kit (contains pre-cut 1/16" SS tubing and 2 PEEK fingertight fittings)
250002	PEEK Fingertight Fitting (10/pk) – suitable for connection of all Ultrasphere columns and pre-columns to all 1/16" tubing types, slip free to >6000psi

The Ultron ES series of chiral columns is manufactured by Shinwa Chemical Industries Ltd., Japan. Columns packed with protein immobilised silica (Ultron ES-OVM and Ultron ES-Pepsin) and chemically bonded cyclodextrin (Ultron ES-CD and ES-PhCD) are available.

Ultron Phases

Ultron Phase	Description	Particle Size (µm)	Pore Size (Å)	pH Range
ES-OVM	Ovomucoid protein	5, 10	120	3 - 7.5
ES-Pepsin	Pepsin	5	120	3 - 6
ES-CD	β-Cyclodextrin	5	120	3 - 7.5
ES-PhCD	Phenylcarbamated β-Cyclodextrin	5	120	3 - 7.5

Ultron ES-OVM and ES-OVM-C

- USP L57 designation
- Wide range of chiral recognition
- Reversed-phase eluents
- No derivatization required

Ultron ES-OVM is a chiral separation column immobilised with ovomucoid protein. Applications include pharmaceutical compounds, pesticides and organic compounds. Figure 1 shows the separation of the widely prescribed drug clopidogrel bisulphate and related substances according to the USP method, which specifies an L57 column. Ultron ES-OVM-C (5µm, 150 x 4.6mm) is a newer version of the Ultron ES-OVM column, specifically tested for clopidogrel bisulphate under the recommended USP conditions.

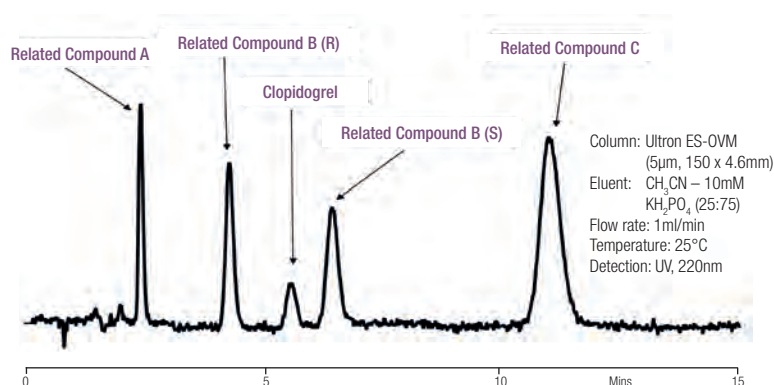

Ultron ES-Pepsin

- Reversed-phase eluents
- No derivatization required

Ultron ES-Pepsin is a chiral separation column immobilised with pepsin. It is particularly effective for the enantiomer separation of basic compounds and is complementary to the more universally applicable Ultron ES-OVM.

Ultron ES-CD and ES-PhCD

- USP L45 designation
- Reversed-phase and normal-phase
- Excellent stability and durability

Ultron ES-CD and ES-PhCD are chiral separation columns chemically bonded with β-cyclodextrin and phenylcarbamated β-cyclodextrin respectively. They are particularly effective for the enantiomeric separation of hydrophobic cyclic compounds.

Ordering Information

Description	Dimensions (mm)	Particle Size (µm)	ES-OVM ³	ES-Pepsin	ES-CD	ES-PhCD
Microbore	150 x 2.0	5	ESOVM-1502	-	ESCD-1502	ESPCD-1502
Analytical	150 x 4.6	5	ESOVM-1546	ESPEP-1546	-	-
Analytical	150 x 6.0	5	ESOVM-1506	-	ESCD-1506	ESPCD-1506
Guard column	10 x 4.0	5	ESOVM-GA	ESPEP-GA	ESCD-GA	ESPCD-GA
Microbore guard cartridge (2/pk)	5 x 2.0	5	ESOVM-GD52 ¹	-	ESCD-GD52 ¹	ESPCD-GD52 ¹
Analytical guard cartridge (2/pk)	10 x 4.6	5	ESOVM-GD1046 ²	-	ESCD-GD1046 ²	ESPCD-GD1046 ²
Analytical	250 x 4.6	10	ESOVM-10-2546	-	-	-
Preparative	250 x 20.0	10	ESOVM-10-2520	-	-	-
Preparative guard	15 x 8.0	10	ESOVM-10-GP	-	-	-

¹ Use with holder ULT-H52 (includes adaptor)

² Use with holder ULT-H1046 (includes adaptor)

³ Ultron ES-OVM-C available as 150 x 4.6mm column. Please specify part number ESOVM-C-1546 when ordering

- Unique selectivity
- High recognition capability of halogenated compounds
- Separation of geometric and positional isomers
- High durability

Fluofix® is a fluorinated silica based material for selective reversed-phase HPLC. Initially manufactured by Neos, it is now manufactured by Wako Chemicals, Japan. The newer Wakopak Fluofix-II 120E is now the recommended Fluofix phase for method development.

Wakopak Phase	Particle Size (µm)	Pore Size (Å)	Surface Area (m ² /g)	Endcapped	Application
Fluofix-II 120E	5	120	300	Yes	General analyses
Fluofix 120E	5	120	300	Yes	General analyses
Fluofix 120N	5	120	300	No	Acidic compounds

Wakopak Fluofix phases are bonded with branched chain perfluorohexyl groups on 120Å pore size silica (see Figure 1). Both endcapped and non-endcapped versions are available. They exhibit increased retention and selectivity of compounds containing fluorine and chlorine substituents when compared to C18 phases. This is due to the more polar nature of the carbon-fluorine bond in Fluofix compared to the carbon-hydrogen bond of C18 phases.

Wakopak Fluofix-II 120E has improved endcapping efficiency, in order to minimise non-specific adsorption compared with Fluofix 120E. The retention capacity of Fluofix-II 120E is comparable to that of a C4 bonded phase.

Figure 2 shows a comparison of the separation of fluorinated positional isomers using Wakopak Fluofix-II 120E, Wakopak Fluofix 120E and ODS (C18) columns. The high shape selectivity observed with Fluofix-II 120E and Fluofix 120E for halogenated isomers, is due to the extra rigidity imposed by the perfluorinated bonded phase.

Wakopak Fluofix phases are also highly selective for the analysis of non-halogenated polar compounds containing hydroxyl, carboxyl, nitro and other polar groups. This is most apparent when the functional groups are located on an aromatic or other rigid ring system.

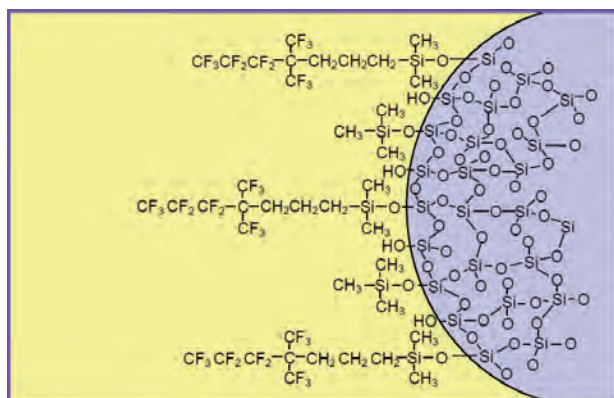

Figure 1. Schematic surface model of Fluofix

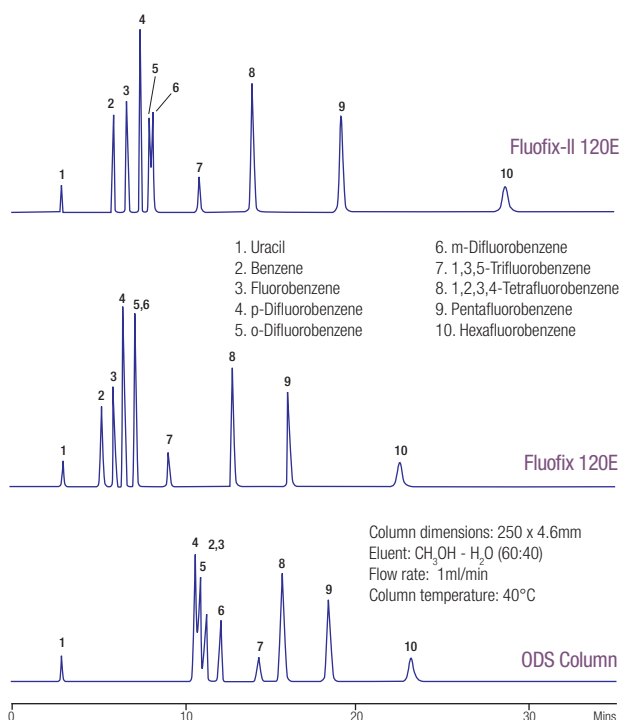

Figure 2. Fluorinated positional isomers*

*The comparative separations presented here may not be representative for all applications.

Ordering Information

Wakopak Phase	Column Dimensions ^{1,2} (mm)						
	50 x 2.0	150 x 2.0	250 x 2.0	30 x 4.6	50 x 4.6	150 x 4.6	250 x 4.6
Fluofix-II 120E	233-63393	236-63403	233-63413	237-63433	230-63423	239-63373	236-63383
Fluofix 120E	236-61943	233-61953	-	237-61973	234-61983	231-61993	238-62003
Fluofix 120N	230-61843	237-61853	-	231-61873	238-61883	235-61893	238-61903

¹ 10mm i.d. columns also available

² Part numbers listed correspond to columns with Waters type endfittings. Columns with DuPont type endfittings also available – please enquire

Wakopak Wakosil columns also available – please enquire for details.

Waters Spherisorb®

- Spherical porous silica
- 3, 5 and 10µm particle sizes
- Widely referenced HPLC columns
- Hichrom high efficiency

Spherisorb® is a classical 80Å pore size silica manufactured by the Waters Corporation. Waters Spherisorb HPLC columns are widely referenced in the scientific literature.

Spherisorb Phases

Spherisorb Phase	Functional Group	Endcapped	Particle Size (µm)	Pore Size (Å)	Surface Area (m ² /g)	Carbon Load (%)
Silica	-	-	3, 5, 10	80	220	-
C1	Methyl	No	3, 5	80	220	2.2
C6	Hexyl	Yes	3, 5	80	220	4.7
C8	Octyl	Yes	3, 5, 10	80	220	5.8
ODS1	Octadecyl	No	3, 5, 10	80	220	6.2
ODS2	Octadecyl	Yes	3, 5, 10	80	220	11.5
ODSB	Octadecyl	Yes	5	80	220	11.5
Phenyl	Phenyl	No	3, 5	80	220	2.5
NH2	Amino	No	3, 5, 10	80	220	1.9
CN	Cyano	No	3, 5	80	220	3.1
SAX	Tetramethyl Ammonium	No	5	80	220	4
SCX	Sulphonic Acid	No	5,10	80	220	4

Ordering Information – Waters Spherisorb - Hichrom Manufactured Columns

Microbore (1.0mm i.d.) Columns

Please contact Hichrom for further details of 1.0mm i.d. Waters Spherisorb columns

Microbore (2.1mm i.d.) Columns

Spherisorb Phase	Column Dimensions ¹ (mm)				Guard Cartridges ^{2,3} (For 2.1mm i.d. Columns)
	50 x 2.1	100 x 2.1	150 x 2.1	250 x 2.1	
3µm					
Silica	S3W-50AM	S3W-100AM	S3W-150AM	S3W-250AM	S3W-10CM5
C1	S3C1-50AM	S3C1-100AM	S3C1-150AM	S3C1-250AM	S3C1-10CM5
C6	S3C6-50AM	S3C6-100AM	S3C6-150AM	S3C6-250AM	S3C6-10CM5
C8	S3C8-50AM	S3C8-100AM	S3C8-150AM	S3C8-250AM	S3C8-10CM5
ODS1	S3ODS1-50AM	S3ODS1-100AM	S3ODS1-150AM	S3ODS1-250AM	S3ODS1-10CM5
ODS2	S3ODS2-50AM	S3ODS2-100AM	S3ODS2-150AM	S3ODS2-250AM	S3ODS2-10CM5
Phenyl	S3P-50AM	S3P-100AM	S3P-150AM	S3P-250AM	S3P-10CM5
NH2	S3NH-50AM	S3NH-100AM	S3NH-150AM	S3NH-250AM	S3NH-10CM5
CN	S3CN-50AM	S3CN-100AM	S3CN-150AM	S3CN-250AM	S3CN-10CM5
5µm					
Silica	S5W-50AM	S5W-100AM	S5W-150AM	S5W-250AM	S5W-10CM5
C1	S5C1-50AM	S5C1-100AM	S5C1-150AM	S5C1-250AM	S5C1-10CM5
C6	S5C6-50AM	S5C6-100AM	S5C6-150AM	S5C6-250AM	S5C6-10CM5
C8	S5C8-50AM	S5C8-100AM	S5C8-150AM	S5C8-250AM	S5C8-10CM5
ODS1	S5ODS1-50AM	S5ODS1-100AM	S5ODS1-150AM	S5ODS1-250AM	S5ODS1-10CM5
ODS2	S5ODS2-50AM	S5ODS2-100AM	S5ODS2-150AM	S5ODS2-250AM	S5ODS2-10CM5
Phenyl	S5P-50AM	S5P-100AM	S5P-150AM	S5P-250AM	S5P-10CM5
NH2	S5NH-50AM	S5NH-100AM	S5NH-150AM	S5NH-250AM	S5NH-10CM5
CN	S5CN-50AM	S5CN-100AM	S5CN-150AM	S5CN-250AM	S5CN-10CM5
ODSB	S5ODSB-50AM	S5ODSB-100AM	S5ODSB-150AM	S5ODSB-250AM	S5ODSB-10CM5
SAX	S5SAX-50AM	S5SAX-100AM	S5SAX-150AM	S5SAX-250AM	S5SAX-10CM5
SCX	S5SCX-50AM	S5SCX-100AM	S5SCX-150AM	S5SCX-250AM	S5SCX-10CM5

¹ Other column dimensions available – please enquire

² Use with free-standing holder HI-161 and column coupler HI-081 – see p. 20

³ 5/pk – Starter kits also available – see p. 21

Ordering Information – Waters Spherisorb® - Hichrom Manufactured Columns (continued)

Medium Bore (3.2mm i.d.) Columns

Spherisorb Phase	Column Dimensions ¹ (mm)				Guard Cartridges ^{2,3} (For 3.2mm i.d. Columns)
	50 x 3.2	100 x 3.2	150 x 3.2	250 x 3.2	
3µm					
Silica	S3W-50AS	S3W-100AS	S3W-150AS	S3W-250AS	S3W-10C5
C1	S3C1-50AS	S3C1-100AS	S3C1-150AS	S3C1-250AS	S3C1-10C5
C6	S3C6-50AS	S3C6-100AS	S3C6-150AS	S3C6-250AS	S3C6-10C5
C8	S3C8-50AS	S3C8-100AS	S3C8-150AS	S3C8-250AS	S3C8-10C5
ODS1	S3ODS1-50AS	S3ODS1-100AS	S3ODS1-150AS	S3ODS1-250AS	S3ODS1-10C5
ODS2	S3ODS2-50AS	S3ODS2-100AS	S3ODS2-150AS	S3ODS2-250AS	S3ODS2-10C5
Phenyl	S3P-50AS	S3P-100AS	S3P-150AS	S3P-250AS	S3P-10C5
NH2	S3NH-50AS	S3NH-100AS	S3NH-150AS	S3NH-250AS	S3NH-10C5
CN	S3CN-50AS	S3CN-100AS	S3CN-150AS	S3CN-250AS	S3CN-10C5
5µm					
Silica	S5W-50AS	S5W-100AS	S5W-150AS	S5W-250AS	S5W-10C5
C1	S5C1-50AS	S5C1-100AS	S5C1-150AS	S5C1-250AS	S5C1-10C5
C6	S5C6-50AS	S5C6-100AS	S5C6-150AS	S5C6-250AS	S5C6-10C5
C8	S5C8-50AS	S5C8-100AS	S5C8-150AS	S5C8-250AS	S5C8-10C5
ODS1	S5ODS1-50AS	S5ODS1-100AS	S5ODS1-150AS	S5ODS1-250AS	S5ODS1-10C5
ODS2	S5ODS2-50AS	S5ODS2-100AS	S5ODS2-150AS	S5ODS2-250AS	S5ODS2-10C5
Phenyl	S5P-50AS	S5P-100AS	S5P-150AS	S5P-250AS	S5P-10C5
NH2	S5NH-50AS	S5NH-100AS	S5NH-150AS	S5NH-250AS	S5NH-10C5
CN	S5CN-50AS	S5CN-100AS	S5CN-150AS	S5CN-250AS	S5CN-10C5
ODSB	S5ODSB-50AS	S5ODSB-100AS	S5ODSB-150AS	S5ODSB-250AS	S5ODSB-10C5
SAX	S5SAX-50AS	S5SAX-100AS	S5SAX-150AS	S5SAX-250AS	S5SAX-10C5
SCX	S5SCX-50AS	S5SCX-100AS	S5SCX-150AS	S5SCX-250AS	S5SCX-10C5

Analytical (4.6mm i.d.) Columns (please enquire for 4.0mm i.d. columns)

Spherisorb Phase	Column Dimensions ¹ (mm)				Guard Cartridges ^{2,3} (For 4.6mm i.d. Columns)
	50 x 4.6	100 x 4.6	150 x 4.6	250 x 4.6	
3µm					
Silica	S3W-50A	S3W-100A	S3W-150A	S3W-250A	S3W-10C5
C1	S3C1-50A	S3C1-100A	S3C1-150A	S3C1-250A	S3C1-10C5
C6	S3C6-50A	S3C6-100A	S3C6-150A	S3C6-250A	S3C6-10C5
C8	S3C8-50A	S3C8-100A	S3C8-150A	S3C8-250A	S3C8-10C5
ODS1	S3ODS1-50A	S3ODS1-100A	S3ODS1-150A	S3ODS1-250A	S3ODS1-10C5
ODS2	S3ODS2-50A	S3ODS2-100A	S3ODS2-150A	S3ODS2-250A	S3ODS2-10C5
Phenyl	S3P-50A	S3P-100A	S3P-150A	S3P-250A	S3P-10C5
NH2	S3NH-50A	S3NH-100A	S3NH-150A	S3NH-250A	S3NH-10C5
CN	S3CN-50A	S3CN-100A	S3CN-150A	S3CN-250A	S3CN-10C5
5µm					
Silica	S5W-50A	S5W-100A	S5W-150A	S5W-250A	S5W-10C5
C1	S5C1-50A	S5C1-100A	S5C1-150A	S5C1-250A	S5C1-10C5
C6	S5C6-50A	S5C6-100A	S5C6-150A	S5C6-250A	S5C6-10C5
C8	S5C8-50A	S5C8-100A	S5C8-150A	S5C8-250A	S5C8-10C5
ODS1	S5ODS1-50A	S5ODS1-100A	S5ODS1-150A	S5ODS1-250A	S5ODS1-10C5
ODS2	S5ODS2-50A	S5ODS2-100A	S5ODS2-150A	S5ODS2-250A	S5ODS2-10C5
Phenyl	S5P-50A	S5P-100A	S5P-150A	S5P-250A	S5P-10C5
NH2	S5NH-50A	S5NH-100A	S5NH-150A	S5NH-250A	S5NH-10C5
CN	S5CN-50A	S5CN-100A	S5CN-150A	S5CN-250A	S5CN-10C5
ODSB	S5ODSB-50A	S5ODSB-100A	S5ODSB-150A	S5ODSB-250A	S5ODSB-10C5
SAX	S5SAX-50A	S5SAX-100A	S5SAX-150A	S5SAX-250A	S5SAX-10C5
SCX	S5SCX-50A	S5SCX-100A	S5SCX-150A	S5SCX-250A	S5SCX-10C5
10µm					
Silica	S10W-50A	S10W-100A	S10W-150A	S10W-250A	S10W-10C5
C8	S10C8-50A	S10C8-100A	S10C8-150A	S10C8-250A	S10C8-10C5
ODS1	S10ODS1-50A	S10ODS1-100A	S10ODS1-150A	S10ODS1-250A	S10ODS1-10C5
ODS2	S10ODS2-50A	S10ODS2-100A	S10ODS2-150A	S10ODS2-250A	S10ODS2-10C5
NH2	S10NH-50A	S10NH-100A	S10NH-150A	S10NH-250A	S10NH-10C5
SCX	S10SCX-50A	S10SCX-100A	S10SCX-150A	S10SCX-250A	S10SCX-10C5

¹ Other column dimensions available – please enquire² Use with free-standing holder HI-161 and column coupler HI-081 – see p. 20³ 5/pk – Starter kits also available – see p. 21

Semi-Preparative and Preparative (7.75 – 21.2mm i.d.) Columns

Please contact Hichrom for further details of 7.75 – 21.2mm i.d. Waters Spherisorb columns

Please contact us for ordering details on all Waters Spherisorb columns not listed

- Porous zirconia based materials
- High pH and temperature stability
- High efficiency
- Fast solvent equilibration
- Long column lifetimes

Zirconia bonded phases, manufactured by ZirChrom Separations, Inc. offer unique selectivity relative to conventional silica based columns, combined with extreme chemical and thermal stability. Unlike polymeric phases, zirconia does not shrink or swell as a function of eluent organic content or ionic strength.

ZirChrom® Phases

ZirChrom Phase	Mode	Particle Size ¹ (µm)	Pore Size (Å)	Surface Area (m ² /g)	Carbon Load (%)	pH Range	Temperature Limit (°C)
PBD	RP	1.9, 3, 5	300	30	2.5	1 - 14	150
PS	RP	3, 5	300	30	1.0	1 - 13	150
EZ	RP	3, 5	300	30	2.7	1 - 10	50
MS	RP	1.9, 3, 5	300	30	3.1	1 - 10	50
CARB	RP	1.9, 3, 5	300	30	-	1 - 14	150
DiamondBond-C18	RP	3, 5	300	30	3.5	1 - 14	200
PHASE	NP + SEC	1.9, 3, 5	300	30	-	1 - 14	150
SAX	Strong Anion-exchange	1.9, 3, 5	300	30	1.2	1 - 12	80
SHAX	Strong Anion-exchange	3, 5	300	30	0.9	1 - 12	80
WAX	Weak Anion-exchange	3, 5	300	30	1.2	3 - 9	50
WCX	Weak Cation-exchange	3, 5	300	30	-	1 - 10	50
PEZ	Cation-exchange	3, 5	300	30	-	1 - 10	50

¹ Additional particle sizes available

Reversed-Phase Materials

ZirChrom-PBD is produced by coating ultra-stable zirconia particles with an extremely thin layer of crosslinked polybutadiene. The chemical selectivity and efficiency of ZirChrom-PBD is similar to that of traditional C8 or C18 silica based columns for non-ionic analytes. However ZirChrom-PBD has greater stability than silica phases and higher efficiencies than polymer phases. Selectivity can be modified by the addition of a strong Lewis base, such as fluoride, phosphate or hydroxide, to the eluent. Figure 1 shows the high pH separation of β -blockers in conjunction with UV detection. ZirChrom-PBD corresponds to the USP L49 designation.

DiamondBond-C18 uses a proprietary covalent bonding technology to graft C18 groups to a carbon-clad zirconia, giving it outstanding stability for LC-MS applications. DiamondBond-C18 has selectivity that is intermediate between ODS silica and unbonded carbon supports for non-electrolytes.

ZirChrom-CARB is produced by coating zirconia particles with a thin layer of elemental carbon. It is an alternative to porous graphitic carbon (PGC) supports for the separation of geometrical isomers, diastereomers and other closely related molecules. It offers very different selectivity to ODS or polymeric materials, making it an excellent choice for orthogonal screening in drug discovery.

ZirChrom-EZ is a highly efficient phase created by first coating zirconia particles with an extremely thin layer of crosslinked polybutadiene and then deactivating the Lewis acid sites by applying a strong metal chelator. This enables Lewis base analytes such as carboxylates, sulphates and phosphates to be analysed throughout the pH range of 1 – 10 using conventional LC-MS buffers such as acetate or formate.

ZirChrom-MS is designed specifically for LC-MS, particularly applications involving basic pharmaceuticals. It has the same deactivation chemistry as ZirChrom-EZ but with a covalent attachment for low bleed and is approximately 2.5 times more retentive for simple compounds. The phase exhibits mixed mode retention characteristics – reversed-phase and cation-exchange.

ZirChrom-PS consists of zirconia coated with an extremely thin layer of polystyrene. The phase offers an alternative selectivity and less retention than ZirChrom-PBD making it ideal for non-polar analytes, or where highly aqueous eluents are necessary.

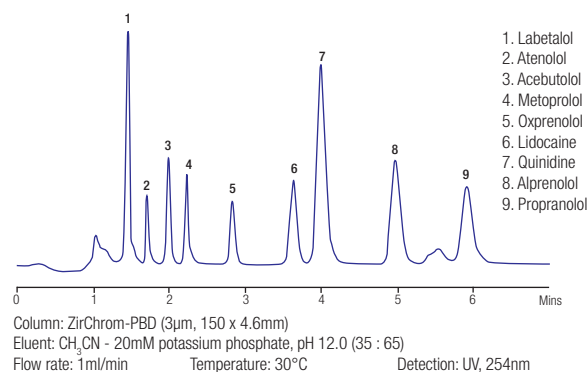

Figure 1. Separation of β -blockers on ZirChrom-PBD

1. Labetalol
2. Atenolol
3. Acebutolol
4. Metoprolol
5. Oxprenolol
6. Lidocaine
7. Quinidine
8. Alprenolol
9. Propranolol

ZirChrom® Ion-Exchange Materials

ZirChrom®-SAX is a highly efficient strong anion-exchanger, created by coating zirconia particles with a thin layer of crosslinked polyethyleneimine. It is useful for the separation of inorganic anions, organic anions and biomolecules such as nucleotides, nucleosides, amino acids and peptides.

ZirChrom-WAX is a highly efficient weak anion-exchanger, produced by coating zirconia particles with a thin layer of crosslinked polyethyleneimine. In addition to separating inorganic anions, organic ions and biomolecules, it is an extremely stable amino phase for the separation of carbohydrates.

ZirChrom-SHAX consists of quaternised polyethyleneimine-coated zirconia and is used for strong hydrophilic anion-exchange. It is more hydrophilic than ZirChrom-SAX, making it useful for the anion-exchange of proteins.

ZirChrom-WCX is a phosphate-coated zirconia phase for weak cation-exchange. It is useful for protein chromatography.

ZirChrom-PEZ is an EDTPA-coated zirconia phase for the cation-exchange chromatography of proteins and the separation of monoclonal antibodies.

Sub 2 micron ZirChrom Phases

A selection of ZirChrom phases is now also available with a particle size of 1.9µm (see Table on page 162). Please contact Hichrom for further details.

ZirChrom-Chiral Columns

Currently, ZirChrom offers 5 different chiral columns in the ZirChrom-Chiral range, in addition to ZirChrom CelluloZe, a cellulose derivative. Please contact Hichrom for ordering information for ZirChrom chiral columns.

ZirChrom Phase	Chiral Selector	Particle Size (µm)	Pore Size (Å)	Surface Area (m ² /g)
Chiral(S)LEU	(S)-3,5-dinitrobenzoylleucine	3, 5	300	30
Chiral(R)NESA	(R)-N-[1-(1-naphthyl)ethyl]succinamic acid	3, 5	300	30
Chiral(S)NESA	(S)-N-[1-(1-naphthyl)ethyl]succinamic acid	3, 5	300	30
Chiral(R)PG	(R)-3,5-dinitrobenzoylphenylglycine	3, 5	300	30
Chiral(S)PG	(S)-3,5-dinitrobenzoylphenylglycine	3, 5	300	30
CelluloZe	3,5-dimethylphenylcarbomoyl cellulose	3, 5	300	30

Sachtopore® Columns

- Highly stable titania based particles
- Reversed-phase and normal-phase
- Ideal for preparative scale-up

Sachtopore Phases

	RP	NP
Bonded Phase	Polyethylene coated TiO ₂	Unbonded TiO ₂
Particle Size (µm)	3, 5	3, 5
Pore Size¹ (Å)	300	300
pH Range	1 - 12	1 - 14
Maximum Temperature	100°C	100°C

¹ Other pore sizes available

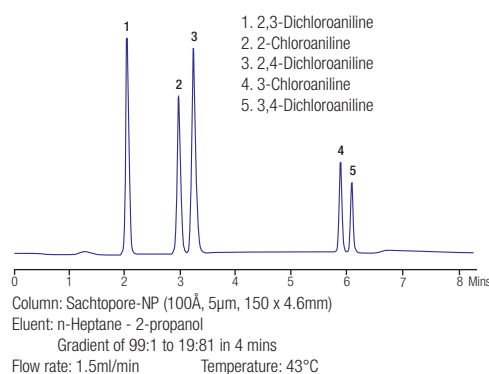

Figure 2. Separation of chloroaniline isomers on Sachtopore-NP

Sachtopore® phases from ZirChrom Separations are based on porous, spherical titania (TiO₂) particles. Sachtopore-NP (normal-phase) is bare titania, whereas Sachtopore-RP (reversed-phase) is polyethylene coated titania. This phase shows similar selectivity to ZirChrom-PBD. Both Sachtopore phases are very chemically and thermally stable and offer unique chromatographic selectivity.

Whereas reversed-phase titania is useful for the separation of basic pharmaceuticals at high pH, Sachtopore-NP can enable the separation of isomeric compounds (see Figure 2).

Sachtopore can also be used in the selective enrichment and purification of phosphorylated peptides from complex mixtures.

All Sachtopore materials are available in microbore, analytical, semi-preparative and preparative formats and a wide range of particle sizes (3, 5, 10, 20, 40 and 80µm) and pore sizes (60, 100, 300, 1000 and 2000Å).

Please contact Hichrom for further information.

Ordering Information – ZirChrom® and Sachtopore® Phases

Phase	Column Dimensions ¹ (mm)						Guard Column	
	50 x 2.1	100 x 2.1	150 x 2.1	50 x 4.6	100 x 4.6	150 x 4.6	For 2.1mm i.d. Columns ²	For 4.6mm i.d. Columns ³
3µm								
PBD	ZR03-0521	ZR03-1021	ZR03-1521	ZR03-0546	ZR03-1046	ZR03-1546	ZR03-G20	ZR03-G40
PS	ZR09-0521	ZR09-1021	ZR09-1521	ZR09-0546	ZR09-1046	ZR09-1546	ZR09-G20	ZR09-G40
EZ	EZ01-0521	EZ01-1021	EZ01-1521	EZ01-0546	EZ01-1046	EZ01-1546	EZ01-G20	EZ01-G40
MS	MS01-0521	MS01-1021	MS01-1521	MS01-0546	MS01-1046	MS01-1546	MS01-G20	MS01-G40
PHASE	ZR02-0521	ZR02-1021	ZR02-1521	ZR02-0546	ZR02-1046	ZR02-1546	ZR02-G20	ZR02-G40
SAX	ZR06-0521	ZR06-1021	ZR06-1521	ZR06-0546	ZR06-1046	ZR06-1546	ZR06-G20	ZR06-G40
SHAX	ZR07-0521	ZR07-1021	ZR07-1521	ZR07-0546	ZR07-1046	ZR07-1546	ZR07-G20	ZR07-G40
WAX	ZR05-0521	ZR05-1021	ZR05-1521	ZR05-0546	ZR05-1046	ZR05-1546	ZR05-G20	ZR05-G40
WCX	ZR04-0521	ZR04-1021	ZR04-1521	ZR04-0546	ZR04-1046	ZR04-1546	ZR04-G20	ZR04-G40
PEZ	ZR08-0521	ZR08-1021	ZR08-1521	ZR08-0546	ZR08-1046	ZR08-1546	ZR08-G20	ZR08-G40
Sachtopore-RP	TI01-0521	TI01-1021	TI01-1521	TI01-0546	TI01-1046	TI01-1546	TI01-G20	TI01-G40
Sachtopore-NP	TI02-0521	TI02-1021	TI02-1521	TI02-0546	TI02-1046	TI02-1546	TI02-G20	TI02-G40
CARB	ZR01-0521	ZR01-1021	ZR01-1521	ZR01-0546	ZR01-1046	ZR01-1546	ZR01-G20	ZR01-G40
DiamondBond-C18	DB01-0521	DB01-1021	DB01-1521	DB01-0546	DB01-1046	DB01-1546	DB01-G20	DB01-G40
5µm								
PBD	ZR03-0521-5	ZR03-1021-5	ZR03-1521-5	ZR03-0546-5	ZR03-1046-5	ZR03-1546-5	ZR03-G20	ZR03-G40
PS	ZR09-0521-5	ZR09-1021-5	ZR09-1521-5	ZR09-0546-5	ZR09-1046-5	ZR09-1546-5	ZR09-G20	ZR09-G40
EZ	EZ01-0521-5	EZ01-1021-5	EZ01-1521-5	EZ01-0546-5	EZ01-1046-5	EZ01-1546-5	EZ01-G20	EZ01-G40
MS	MS01-0521-5	MS01-1021-5	MS01-1521-5	MS01-0546-5	MS01-1046-5	MS01-1546-5	MS01-G20	MS01-G40
PHASE	ZR02-0521-5	ZR02-1021-5	ZR02-1521-5	ZR02-0546-5	ZR02-1046-5	ZR02-1546-5	ZR02-G20	ZR02-G40
SAX	ZR06-0521-5	ZR06-1021-5	ZR06-1521-5	ZR06-0546-5	ZR06-1046-5	ZR06-1546-5	ZR06-G20	ZR06-G40
SHAX	ZR07-0521-5	ZR07-1021-5	ZR07-1521-5	ZR07-0546-5	ZR07-1046-5	ZR07-1546-5	ZR07-G20	ZR07-G40
WAX	ZR05-0521-5	ZR05-1021-5	ZR05-1521-5	ZR05-0546-5	ZR05-1046-5	ZR05-1546-5	ZR05-G20	ZR05-G40
WCX	ZR04-0521-5	ZR04-1021-5	ZR04-1521-5	ZR04-0546-5	ZR04-1046-5	ZR04-1546-5	ZR04-G20	ZR04-G40
PEZ	ZR08-0521-5	ZR08-1021-5	ZR08-1521-5	ZR08-0546-5	ZR08-1046-5	ZR08-1546-5	ZR08-G20	ZR08-G40
Sachtopore-RP	TI01-0521-5	TI01-1021-5	TI01-1521-5	TI01-0546-5	TI01-1046-5	TI01-1546-5	TI01-G20	TI01-G40
Sachtopore-NP	TI02-0521-5	TI02-1021-5	TI02-1521-5	TI02-0546-5	TI02-1046-5	TI02-1546-5	TI02-G20	TI02-G40
CARB	ZR01-0521-5	ZR01-1021-5	ZR01-1521-5	ZR01-0546-5	ZR01-1046-5	ZR01-1546-5	ZR01-G20	ZR01-G40
DiamondBond-C18	DB01-0521-5	DB01-1021-5	DB01-1521-5	DB01-0546-5	DB01-1046-5	DB01-1546-5	DB01-G20	DB01-G40

¹ Other dimension columns available on request² 3/pk – Use with guard holder Z-852-00³ 3/pk – Use with guard holder Z-850-00

Reversed-phase and ion-exchange method development kits are also available.

Please contact Hichrom for ordering information for ZirChrom 1.9µm particle size columns and for ZirChrom chiral columns.

ProTain® In-Line Protein Removal

ProTain® is a system for the effective in-line removal of matrix proteins from samples. It is based on a 3µm polymer-coated zirconia material which acts as a protein sponge, allowing small molecules of interest to pass through the analytical column. ProTain can be used in-line with any type of silica, polymer or zirconia-based analytical column.

Ordering Information

Description	Dimensions	
	20 x 2.1	20 x 4.6
ProTain Media Insert ¹ (3/pk)	PT01-0221	PT01-0246
Holder	Z-852-00-2	Z-850-00-2

¹ Holder required for use – includes capillary tubing, nuts and ferrules

- Spherical porous silica
- Narrow particle and pore size distribution
- Hichrom high efficiency

ZORBAX® spherical particles are manufactured from small uniform colloidal silica microbeads which are agglutinated in a Du Pont patented organic polymerisation process. The organic polymer is removed by a controlled sintering process to yield mechanically stable silica particles. ZORBAX is manufactured by Agilent Technologies Inc. Their original ZORBAX phases (listed below) are based on Type A silica.

ZORBAX Phases

ZORBAX Phase	Functional Group	Endcapped	Particle Size (µm)	Pore Size (Å)	Surface Area (m ² /g)	Carbon Load (%)
Silica	-	-	5	70	330	-
TMS	Methyl	Yes	5	70	330	4
C8	Octyl	Yes	5	70	330	12
ODS	Octadecyl	Yes	5	70	330	20
Phenyl	Phenyl	Yes	5	70	330	12
NH2	Amino	Yes	5	70	330	4
CN	Cyano	Yes	5	70	330	7

Ordering Information – Hichrom Manufactured Columns

Microbore (1.0mm i.d.) Columns

Please contact Hichrom for further details of 1.0mm i.d. ZORBAX columns.

Microbore (2.1mm i.d.) Columns

5µm ZORBAX Phase	Column Dimensions ¹ (mm)				Guard Cartridges ^{2,3} (For 2.1mm i.d. Columns)
	50 x 2.1	100 x 2.1	150 x 2.1	250 x 2.1	
Silica	ZSIL-50AM	ZSIL-100AM	ZSIL-150AM	ZSIL-250AM	ZSIL-10CM5
TMS	ZTMS-50AM	ZTMS-100AM	ZTMS-150AM	ZTMS-250AM	ZTMS-10CM5
C8	ZC8-50AM	ZC8-100AM	ZC8-150AM	ZC8-250AM	ZC8-10CM5
ODS	ZODS-50AM	ZODS-100AM	ZODS-150AM	ZODS-250AM	ZODS-10CM5
Phenyl	ZPH-50AM	ZPH-100AM	ZPH-150AM	ZPH-250AM	ZPH-10CM5
NH2	ZNH-50AM	ZNH-100AM	ZNH-150AM	ZNH-250AM	ZNH-10CM5
CN	ZCN-50AM	ZCN-100AM	ZCN-150AM	ZCN-250AM	ZCN-10CM5

Medium Bore (3.2mm i.d.) Columns

5µm ZORBAX Phase	Column Dimensions ¹ (mm)				Guard Cartridges ^{2,3} (For 3.2mm i.d. Columns)
	50 x 3.2	100 x 3.2	150 x 3.2	250 x 3.2	
Silica	ZSIL-50AS	ZSIL-100AS	ZSIL-150AS	ZSIL-250AS	ZSIL-10C5
TMS	ZTMS-50AS	ZTMS-100AS	ZTMS-150AS	ZTMS-250AS	ZTMS-10C5
C8	ZC8-50AS	ZC8-100AS	ZC8-150AS	ZC8-250AS	ZC8-10C5
ODS	ZODS-50AS	ZODS-100AS	ZODS-150AS	ZODS-250AS	ZODS-10C5
Phenyl	ZPH-50AS	ZPH-100AS	ZPH-150AS	ZPH-250AS	ZPH-10C5
NH2	ZNH-50AS	ZNH-100AS	ZNH-150AS	ZNH-250AS	ZNH-10C5
CN	ZCN-50AS	ZCN-100AS	ZCN-150AS	ZCN-250AS	ZCN-10C5

¹ Other column dimensions available – please enquire

² Use with free-standing holder HI-161 and column coupler HI-081 – see p.20

³ 5/pk – Starter kits also available – see p.21

Analytical (4.0mm i.d.) Columns

Please contact Hichrom for further details of 4.0mm i.d. ZORBAX columns.

ZORBAX® – Hichrom Manufactured Columns (continued)

Analytical (4.6mm i.d.) Columns

5µm ZORBAX Phase	Column Dimensions ¹ (mm)				Guard Cartridges ^{2,3} (For 4.6mm i.d. Columns)
	50 x 4.6	100 x 4.6	150 x 4.6	250 x 4.6	
Silica	ZSIL-50A	ZSIL-100A	ZSIL-150A	ZSIL-250A	ZSIL-10C5
TMS	ZTMS-50A	ZTMS-100A	ZTMS-150A	ZTMS-250A	ZTMS-10C5
C8	ZC8-50A	ZC8-100A	ZC8-150A	ZC8-250A	ZC8-10C5
ODS	ZODS-50A	ZODS-100A	ZODS-150A	ZODS-250A	ZODS-10C5
Phenyl	ZPH-50A	ZPH-100A	ZPH-150A	ZPH-250A	ZPH-10C5
NH2	ZNH-50A	ZNH-100A	ZNH-150A	ZNH-250A	ZNH-10C5
CN	ZCN-50A	ZCN-100A	ZCN-150A	ZCN-250A	ZCN-10C5

Semi-Preparative (7.75mm i.d.) Columns

5µm ZORBAX Phase	Column Dimensions ¹ (mm)				Guard Cartridges ⁴ (For 7.75mm i.d. Columns)
	50 x 7.75	100 x 7.75	150 x 7.75	250 x 7.75	
Silica	ZSIL-50SP	ZSIL-100SP	ZSIL-150SP	ZSIL-250SP	ZSIL-10CP3
TMS	ZTMS-50SP	ZTMS-100SP	ZTMS-150SP	ZTMS-250SP	ZTMS-10CP3
C8	ZC8-50SP	ZC8-100SP	ZC8-150SP	ZC8-250SP	ZC8-10CP3
ODS	ZODS-50SP	ZODS-100SP	ZODS-150SP	ZODS-250SP	ZODS-10CP3
Phenyl	ZPH-50SP	ZPH-100SP	ZPH-150SP	ZPH-250SP	ZPH-10CP3
NH2	ZNH-50SP	ZNH-100SP	ZNH-150SP	ZNH-250SP	ZNH-10CP3
CN	ZCN-50SP	ZCN-100SP	ZCN-150SP	ZCN-250SP	ZCN-10CP3

Semi-Preparative (10.0mm i.d.) Columns

5µm ZORBAX Phase	Column Dimensions ¹ (mm)				Guard Cartridges ⁴ (For 10.0mm i.d. Columns)
	50 x 10.0	100 x 10.0	150 x 10.0	250 x 10.0	
Silica	ZSIL-50SP1	ZSIL-100SP1	ZSIL-150SP1	ZSIL-250SP1	ZSIL-10CP3
TMS	ZTMS-50SP1	ZTMS-100SP1	ZTMS-150SP1	ZTMS-250SP1	ZTMS-10CP3
C8	ZC8-50SP1	ZC8-100SP1	ZC8-150SP1	ZC8-250SP1	ZC8-10CP3
ODS	ZODS-50SP1	ZODS-100SP1	ZODS-150SP1	ZODS-250SP1	ZODS-10CP3
Phenyl	ZPH-50SP1	ZPH-100SP1	ZPH-150SP1	ZPH-250SP1	ZPH-10CP3
NH2	ZNH-50SP1	ZNH-100SP1	ZNH-150SP1	ZNH-250SP1	ZNH-10CP3
CN	ZCN-50SP1	ZCN-100SP1	ZCN-150SP1	ZCN-250SP1	ZCN-10CP3

Preparative (21.2mm i.d.) Columns

5µm ZORBAX Phase	Column Dimensions ¹ (mm)				Guard Cartridges ⁴ (For 21.2mm i.d. Columns)
	50 x 21.2	100 x 21.2	150 x 21.2	250 x 21.2	
Silica	ZSIL-50P	ZSIL-100P	ZSIL-150P	ZSIL-250P	ZSIL-10CP3
TMS	ZTMS-50P	ZTMS-100P	ZTMS-150P	ZTMS-250P	ZTMS-10CP3
C8	ZC8-50P	ZC8-100P	ZC8-150P	ZC8-250P	ZC8-10CP3
ODS	ZODS-50P	ZODS-100P	ZODS-150P	ZODS-250P	ZODS-10CP3
Phenyl	ZPH-50P	ZPH-100P	ZPH-150P	ZPH-250P	ZPH-10CP3
NH2	ZNH-50P	ZNH-100P	ZNH-150P	ZNH-250P	ZNH-10CP3
CN	ZCN-50P	ZCN-100P	ZCN-150P	ZCN-250P	ZCN-10CP3

¹ Other column dimensions available – please enquire² Use with free-standing holder HI-161 and column coupler HI-081 – see p.20³ 5/pk – Starter kits also available – see p.21⁴ 3/pk – Use with free-standing holder HI-150 and column coupler HI-081

Please contact us for ordering details on
all ZORBAX columns not listed

GC COLUMN SELECTION BY USP SPECIFICATIONS

The USP specifications for GC column selection are given below with some matching capillary columns. In some cases, a particular column may fit into more than one category.

Method	Phase Composition	Recommendations
G1	Dimethylpolysiloxane oil	HiCap 1MS, TG-1MS, TR-1MS, DB-1ms, HP-1ms, OPTIMA 1 MS
G2	Dimethylpolysiloxane gum	HiCap 1MS, TG-1MS, TR-1MS, DB-1ms, HP-1ms, OPTIMA 1 MS
G3	50% Phenyl-50% methylpolysiloxane	HiCap 17MS, TG-17MS, TR-50MS, DB-17ms, OPTIMA 17 MS
G5	3-Cyanopropylpolysiloxane	TR-FAME, DB-23
G6	Trifluoropropylmethylpolysiloxane	HiCap 210, TG-200MS, DB-210, OPTIMA 210
G7	50% 3-Cyanopropyl-50% phenylmethylsilicone	HiCap 225, TG-225MS, TR-225, DB-225ms, OPTIMA 225
G9	Methylvinylpolysiloxane	DB-1ms, DB-1ht
G14	Polyethylene glycol (ave. mol. wt. of 950 to 1050)	DB-WAX, DB-WAXetr, HP-INNOWAX
G15	Polyethylene glycol (ave. mol. wt. of 3000 to 3700)	DB-WAX, DB-WAXetr, HP-INNOWAX
G16	Polyethylene glycol (ave. mol. wt. ~15,000) with diepoxide linker	HiCap WAX, HiCap WAX ETR, HiCap WAX2, OPTIMA WAX, TR-Wax, TG-WaxMS,
G17	75% Phenyl-25% methylpolysiloxane	DB-17ms, HP-50+
G19	25% Phenyl-25% cyanopropyl-50% methylsilicone	HiCap 225, TG-225MS, DB-225ms, OPTIMA 225
G20	Polyethylene glycol (ave. mol. wt. of 380 to 420)	HiCap WAX, HiCap WAX2, HiCap WAX ETR, TR-Wax, TG-WaxMS, DB-WAX
G25	Polyethylene glycol TPA (Carbowax 20M terephthalic acid)	TR-FFAP, DB-FFAP, HP-FFAP, OPTIMA FFAP
G27	5% Phenyl-95% methylpolysiloxane	HiCap 5MS, TG-5MS, TR-5MS, DB-5ms, HP-5ms, OPTIMA 5 MS
G28	25% Phenyl-75% methylpolysiloxane	HiCap 25, DB-35, HP-35, OPTIMA 35 MS
G32	20% Phenylmethyl-80% dimethylpolysiloxane	DB-35ms, HP-35
G35	Polyethylene glycol and diepoxide esterified with nitroterephthalic acid	HiCap FFAP, DB-FFAP, HP-FFAP, OPTIMA FFAP
G36	1% Vinyl-5% phenylmethylpolysiloxane	TR-5MS, DB-5ms, HP-5ms, OPTIMA 5 MS
G38	Phase G1 plus a tailing inhibitor	TR-1MS, HP-1ms, DB-1ms, OPTIMA 1 MS
G39	Polyethylene glycol (ave. mol. wt. about 1500)	HiCap WAX, HiCap WAX2, HiCap WAX ETR, DB-Wax, HP-INNOWAX
G41	Phenylmethyldimethylsilicone (10% phenyl-substituted)	HiCap 5MS2, DB-5, DB-5ms, HP-5, HP-5ms
G42	35% Phenyl-65% dimethylpolysiloxane	HiCap 35, TG-35MS, TR-35MS, DB-35ms, OPTIMA 35 MS
G43	6% Cyanopropylphenyl-94% dimethylpolysiloxane	HiCap 624, HiCap 1301, TG-624, TG-17MS, TG-1301MS, TR-V1, DB-1301, DB-624, OPTIMA 1301, OPTIMA 624
G45	Divinylbenzene-ethyleneglycol-dimethacrylate	TG-Bond U
G46	14% Cyanopropylphenyl-86% methylpolysiloxane	HiCap 1701, TG-1701MS, TR-1701, DB-1701, OPTIMA 1701
G47	Polyethylene glycol (ave. mol. wt. of about 8000)	DB-Wax, HP-INNOWAX
G48	90% Biscyanopropyl 10% cyanopropylphenylpolysiloxane	TG-POLAR, HP-88
G49	Proprietary derivatized phenyl groups on a polysiloxane backbone	OPTIMA δ-3

Packed GC Columns

Hichrom also supply a range of packed GC columns. Please enquire regarding ordering information and availability of packed GC columns.

- Excellent reproducibility
- High separation efficiency
- Low GC-MS bleed
- Wide range of phases



Hichrom's HiCap capillary GC columns are manufactured to high specifications and demonstrate both excellent reproducibility and high separation efficiency. A wide range of different polarity phases are available for both general purpose and application specific analyses. HiCap 1MS, 5MS, 5MS2 and 17MS are high performance, low bleed phases designed specifically for GC-MS analyses. In addition, less column conditioning is required between analyses.

HiCap Range of Phases

Phase	Phase Composition	Polarity	Max. Temp. (°C)*	Applications
HiCap 1MS	100% Dimethylpolysiloxane	Low	325/350	General purpose, hydrocarbons, PCBs, high volatility solvents, phenols
HiCap 1	100% Dimethylpolysiloxane	Low	325/350	General purpose, hydrocarbons, PCBs, high volatility solvents, phenols
HiCap 5MS	5% Phenyl-95% methylpolysiloxane	Slight	325/350	General purpose, phenols, pesticides, halogenated compounds, FAMES
HiCap 5MS2	5% Phenyl-95% methylpolysilylene	Slight	325/350	General purpose, phenols, pesticides, halogenated compounds, FAMES
HiCap 5	5% Phenyl-95% methylpolysiloxane	Slight	325/350	General purpose, phenols, pesticides, halogenated compounds, FAMES
HiCap PE	5% Phenyl-95% methylpolysiloxane	Slight	325/350	Pesticides
HiCap 1301	6% Cyanopropylphenyl-94% methylpolysiloxane	Medium	280/300	Pesticides, PCBs, alcohols, VOCs
HiCap 624	6% Cyanopropylphenyl-94% methylpolysiloxane	Medium	260/260	VOCs, alcohols
HiCap 25	25% Phenyl-75% methylpolysiloxane	Medium	280/300	Pesticides, PCBs, alcohols, VOCs
HiCap VOC	25% Phenyl-75% methylpolysiloxane	Medium	200/220	VOCs, organic solvents
HiCap S0			260/260	
HiCap 35	35% Phenyl-65% methylpolysiloxane	Medium	280/300	Pesticides, amines, drugs of abuse, PCBs
HiCap 1701	14% Cyanopropylphenyl-86% methylpolysiloxane	Medium	280/300	Sugars, TMS derivatives, drugs, alcohols, steroids
HiCap 17MS	50% Phenyl-50% methylpolysiloxane	Medium	320/340	Drugs, pesticides, steroids
HiCap 17	50% Phenyl-50% methylpolysiloxane	Medium	320/340	Drugs, pesticides, steroids
HiCap 210	50% Trifluoropropyl-50% methylpolysiloxane	Medium	240/260	Organophosphorus pesticides
HiCap 225	50% Cyanopropylmethyl-50% phenylmethylpolysiloxane	Medium	220/240	FAMES, geometrical isomers, food and flavour components
HiCap WAX	Polyethylene glycol	High	250/260	Esters, perfumes, flavours, alcohols, aromatic hydrocarbons, FAMES
HiCap WAX2	Polyethylene glycol	High	260/260	Esters, perfumes, flavours, alcohols, aromatic hydrocarbons, FAMES
HiCap WAX ETR	Polyethylene glycol	High	270/280	Esters, perfumes, flavours, alcohols, aromatic hydrocarbons, FAMES
HiCap FFAP	Nitroterephthalic acid modified polyethylene glycol	High	240/250	Free fatty acids, aldehydes, ketones, alcohols, organic acids
HiCap AM	Proprietary	-	265/300	Amines

* Two temperature limits are listed, the lower one for isothermal conditions and the higher one for temperature programmed operations. For columns with 0.53mm i.d. or with thicker films, temperature limits are generally lower.

HiCap 5MS vs HiCap 5MS2

The HiCap 5MS and HiCap 5MS2 phases show virtually identical selectivity. However, HiCap 5MS2 incorporates arylene bonding into the siloxane polymer. This strengthens the polymer backbone, thereby reducing stationary phase degradation and bleed.

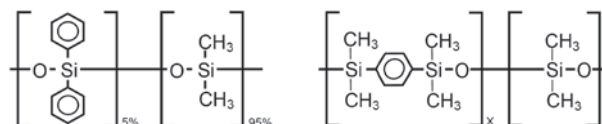

HiCap 5 and HiCap 5MS

HiCap 5MS2

Please see page 170 for ordering information.

Application Examples

Column: HiCap WAX (60m x 0.25mm x 0.25µm)
 Temperature: 40°C (5 min. hold) to 230°C at 4°C/min
 Flow rate: He 1ml/min, split ratio 1/100
 Sample size: 2.0µl

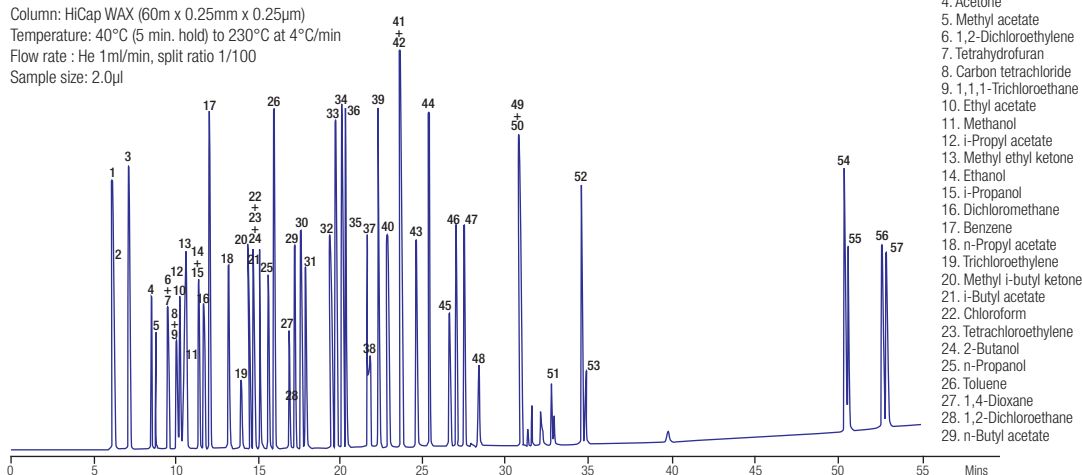

Figure 1. Organic solvents

Column: HiCap 35 (30m x 0.25mm x 0.25µm)
 Temperature: 60°C to 290°C at 10°C/min (7 min. hold)
 Flow rate: He 35cm/sec, split ratio 1/30
 Sample size: 2.0µl
 Detection: MS

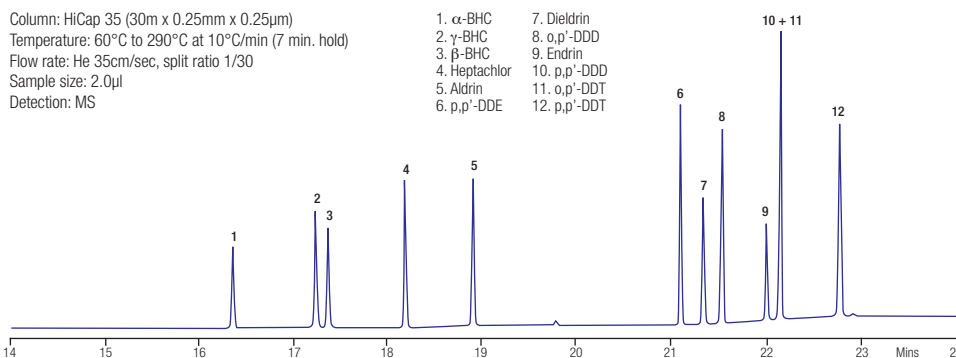

Figure 2. Pesticides

Column: HiCap 225 (30m x 0.25mm x 0.25µm)
 Temperature: 40°C (1 min. hold) to 220°C at 10°C/min (30 min. hold)
 Injection: split 1:50
 Sample size: 0.4µl
 Detection: FID

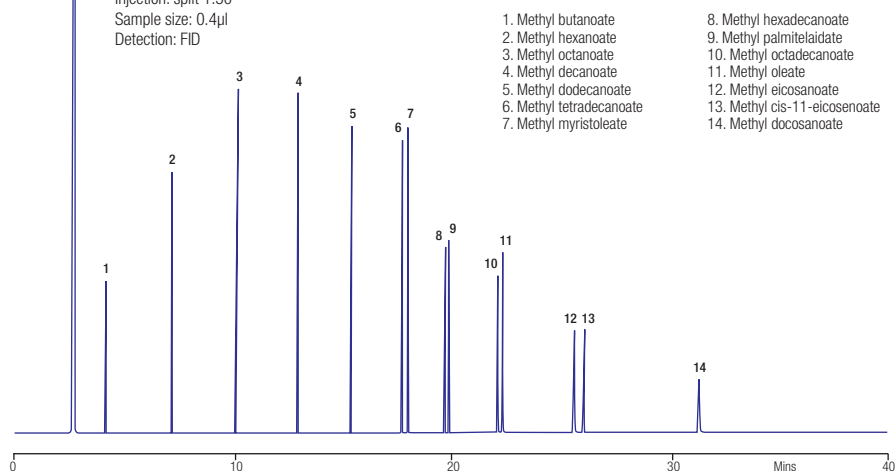

Figure 3. Fatty Acid Methyl Esters (FAMES)

Ordering Information for HiCap Capillary GC Columns

The following ordering information relates to a selection of dimensions for some of the more popular phases. Other phases (see page 168) and dimensions are available. Please enquire for details.

Column Dimensions			HiCap 1MS	HiCap 5MS	HiCap 5MS2	HiCap 17MS
I.D. (mm)	Length (m)	Film (µm)				
0.25	15	0.25	HI1MS-0.25-15-0.25	HI5MS-0.25-15-0.25	HI5MS2-0.25-15-0.25	HI17MS-0.25-15-0.25
		0.10	HI1MS-0.25-30-0.10	HI5MS-0.25-30-0.10	HI5MS2-0.25-30-0.10	-
	30	0.25	HI1MS-0.25-30-0.25	HI5MS-0.25-30-0.25	HI5MS2-0.25-30-0.25	HI17MS-0.25-30-0.25
60		0.25	HI1MS-0.25-60-0.25	HI5MS-0.25-60-0.25	HI5MS2-0.25-60-0.25	HI17MS-0.25-60-0.25
0.32	30	0.25	HI1MS-0.32-30-0.25	HI5MS-0.32-30-0.25	HI5MS2-0.32-30-0.25	HI17MS-0.32-30-0.25
	60	0.25	HI1MS-0.32-60-0.25	HI5MS-0.32-60-0.25	HI5MS2-0.32-60-0.25	HI17MS-0.32-60-0.25

Column Dimensions			HiCap 1	HiCap 5	HiCap 25	HiCap 35	HiCap 1701
I.D. (mm)	Length (m)	Film (µm)					
0.25	15	0.25	HI1-0.25-15-0.25	HI5-0.25-15-0.25	HI25-0.25-15-0.25	HI35-0.25-15-0.25	HI1701-0.25-15-0.25
		0.50	HI1-0.25-15-0.50	HI5-0.25-15-0.50	HI25-0.25-15-0.50	HI35-0.25-15-0.50	HI1701-0.25-15-0.50
		0.10	HI1-0.25-30-0.10	HI5-0.25-30-0.10	-	-	-
	30	0.25	HI1-0.25-30-0.25	HI5-0.25-30-0.25	HI25-0.25-30-0.25	HI35-0.25-30-0.25	HI1701-0.25-30-0.25
		0.50	HI1-0.25-30-0.50	HI5-0.25-30-0.50	HI25-0.25-30-0.50	HI35-0.25-30-0.50	HI1701-0.25-30-0.50
		1.00	HI1-0.25-30-1.00	HI5-0.25-30-1.00	HI25-0.25-30-1.00	HI35-0.25-30-1.00	HI1701-0.25-30-1.00
	60	0.25	HI1-0.25-60-0.25	HI5-0.25-60-0.25	HI25-0.25-60-0.25	HI35-0.25-60-0.25	HI1701-0.25-60-0.25
		0.50	HI1-0.25-60-0.50	HI5-0.25-60-0.50	HI25-0.25-60-0.50	HI35-0.25-60-0.50	HI1701-0.25-60-0.50
		1.00	HI1-0.25-60-1.00	HI5-0.25-60-1.00	HI25-0.25-60-1.00	HI35-0.25-60-1.00	HI1701-0.25-60-1.00
0.32	15	0.25	HI1-0.32-15-0.25	HI5-0.32-15-0.25	HI25-0.32-15-0.25	HI35-0.32-15-0.25	HI1701-0.32-15-0.25
		0.50	-	-	HI25-0.32-15-0.50	HI35-0.32-15-0.50	HI1701-0.32-15-0.50
		1.00	-	-	HI25-0.32-15-1.00	HI35-0.32-15-1.00	HI1701-0.32-15-1.00
	30	0.25	HI1-0.32-30-0.25	HI5-0.32-30-0.25	HI25-0.32-30-0.25	HI35-0.32-30-0.25	HI1701-0.32-30-0.25
		0.50	HI1-0.32-30-0.50	HI5-0.32-30-0.50	HI25-0.32-30-0.50	HI35-0.32-30-0.50	HI1701-0.32-30-0.50
		1.00	HI1-0.32-30-1.00	HI5-0.32-30-1.00	HI25-0.32-30-1.00	HI35-0.32-30-1.00	HI1701-0.32-30-1.00
	60	0.25	HI1-0.32-60-0.25	HI5-0.32-60-0.25	HI25-0.32-60-0.25	HI35-0.32-60-0.25	HI1701-0.32-60-0.25
		0.50	HI1-0.32-60-0.50	HI5-0.32-60-0.50	HI25-0.32-60-0.50	HI35-0.32-60-0.50	HI1701-0.32-60-0.50
		1.00	HI1-0.32-60-1.00	-	HI25-0.32-60-1.00	HI35-0.32-60-1.00	HI1701-0.32-60-1.00
0.53	15	1.00	HI1-0.53-15-1.00	HI5-0.53-15-1.00	HI25-0.53-15-1.00	HI35-0.53-60-1.00	HI1701-0.53-60-1.00
		2.00	HI1-0.53-15-2.00	HI5-0.53-15-2.00	-	-	-
		3.00	HI1-0.53-15-3.00	HI5-0.53-15-3.00	-	-	-
	30	1.00	HI1-0.53-30-1.00	HI5-0.53-30-1.00	HI25-0.53-30-1.00	HI35-0.53-30-1.00	HI1701-0.53-30-1.00
		1.50	HI1-0.53-30-1.50	HI5-0.53-30-1.50	-	-	-
		2.00	HI1-0.53-30-2.00	HI5-0.53-30-2.00	-	-	-
	60	3.00	HI1-0.53-30-3.00	HI5-0.53-30-3.00	-	-	-
		5.00	HI1-0.53-30-5.00	HI5-0.53-30-5.00	-	-	-
		5.00	HI1-0.53-60-5.00	-	-	-	-

Column Dimensions			HiCap WAX	HiCap WAX2	HiCap WAX ETR	HiCap FFAP
I.D. (mm)	Length (m)	Film (µm)				
0.25	15	0.25	HIWAX-0.25-15-0.25	-	HIWAXETR-0.25-15-0.25	HIFFAP-0.25-15-0.25
	30	0.25	HIWAX-0.25-30-0.25	HIWAX2-0.25-30-0.25	HIWAXETR-0.25-30-0.25	HIFFAP-0.25-30-0.25
	60	0.25	HIWAX-0.25-60-0.25	HIWAX2-0.25-60-0.25	HIWAXETR-0.25-60-0.25	HIFFAP-0.25-60-0.25
0.50		HIWAX-0.25-60-0.50	HIWAX2-0.25-60-0.50	HIWAXETR-0.25-60-0.50	HIFFAP-0.25-60-0.50	
0.32	30	0.25	HIWAX-0.32-30-0.25	HIWAX2-0.32-30-0.25	HIWAXETR-0.32-30-0.25	HIFFAP-0.32-30-0.25
	60	0.25	HIWAX-0.32-60-0.25	HIWAX2-0.32-60-0.25	HIWAXETR-0.32-60-0.25	HIFFAP-0.32-60-0.25
0.53	15	1.00	HIWAX-0.53-15-1.00	HIWAX2-0.53-15-1.00	HIWAXETR-0.53-15-1.00	HIFFAP-0.53-15-1.00
	30	1.00	HIWAX-0.53-30-1.00	HIWAX2-0.53-30-1.00	HIWAXETR-0.53-30-1.00	HIFFAP-0.53-30-1.00

Column Dimensions			HiCap 624	HiCap VOC	HiCap S0
I.D. (mm)	Length (m)	Film (µm)			
0.25	30	1.40	HI624-0.25-30-1.40	-	HIS0-0.25-30-1.40
	60	1.00	-	HIVOC-0.25-60-1.00	-
		1.40	HI624-0.25-60-1.40	-	HIS0-0.25-60-1.40
0.32	30	1.80	HI624-0.32-30-1.80	-	HIS0-0.32-30-1.80
	60	1.40	-	HIVOC-0.32-60-1.40	-
		1.80	HI624-0.32-60-1.80	-	HIS0-0.32-60-1.80
0.53	30	3.00	HI624-0.53-30-3.00	-	HIS0-0.53-30-3.00
	75	3.00	HI624-0.53-75-3.00	-	HIS0-0.53-75-3.00

- Increase sample volatility
- Improve selectivity and efficiency
- Enhance detectability

GC derivatization is frequently used to simplify complex separation problems. For GC analysis, this has a number of benefits including those detailed above. Hichrom offers a range of GC derivatization reagents as detailed below. Please enquire for details of any product not listed.

Derivatization Reagents

A wide range of reagents is available for silylation, acylation or alkylation of reactive functional groups. A selection of these reagents is discussed below.

BSTFA + TMCS (1%, 10%)

[N,O-Bis(trimethylsilyl)trifluoroacetamide]

- Highly volatile and stable products
- Excellent solubility and solvency
- Addition of TMCS catalyzes reactions of hindered functional groups and other difficult functionalities

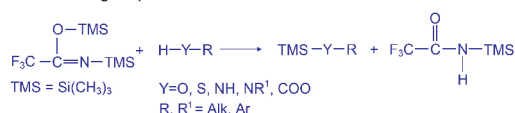

MSTFA

[N-Methyltrimethylsilyltrifluoroacetamide]

- Most volatile of the TMS-acetamides
- Useful in analysis of volatile trace materials where derivatives elute near reagent or byproduct peak

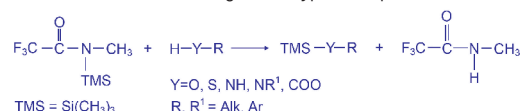

MTBSTFA/MTBSTFA + 1% t-BDMCS

[N-Methyl-N-(t-butyldimethylsilyl)trifluoroacetamide]

- Derivatives are 10⁴ times more stable to hydrolysis than corresponding TMS derivatives
- Produce easily interpreted mass spectra for GC-MS
- Addition of t-BDMCS catalyzes reactions of hindered alcohols and amines

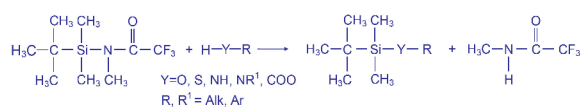

TMSI

[Trimethylsilylimidazole]

- Potent, selective TMS donor that reacts with hydroxyls but not amines or amides
- Derivatizes wet sugar samples, hindered hydroxyl groups in steroids, and amino acids in fluorinated acylation reagents

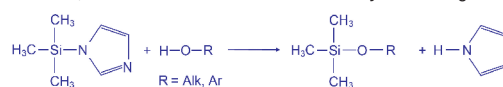

PFPA

[Pentafluoropropionic anhydride]

- Most commonly used for ECD
- Reacts with alcohols, amines and phenols
- Frequently used for drugs of abuse confirmation



PFPOH

[2,2,3,3,3-Pentafluoropropanol]

- Used in combination with PFPA to make ECD derivatives of the most common functional groups, especially polyfunctional bio-organic compounds

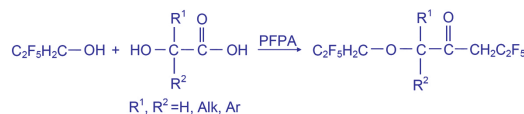

Ordering Information - Regis GC Derivatization Reagents¹

Reagent	Package Size ²			
	10 x 1g (ampoule)	5g	4 x 5g	25g
BSTFA	270111	-	270112	270113
BSTFA + 1% TMCS	270121	-	270122	270123
BSTFA + 10% TMCS	270131	-	270132	270133
MSTFA	270590	-	-	270593
MTBSTFA	-	-	-	270243
MTBSTFA + t-BDMCS	270144	-	-	270143
TMSI	270401	270402	-	270403
PFPA	640110	-	-	640113
PFPOH	-	270815	-	270816

¹ Other reagents available – please enquire ² Other package sizes available – please enquire

Regis also offers a wide range of additional derivatization and other reagents. Please contact Hichrom for information on reagents not listed here.

Inlet Liners

Choosing the optimum inlet liner and injection parameters for a specific application can increase peak areas and reduce detection limits. Characteristics including liner volume, liner treatments and deactivation and liner design are all important. Deactivation procedures are used to produce inert liners with long lifetimes. These are particularly useful for splitless injections or for analysis of polar compounds. Many liner designs use deactivated glass wool packing, placed near the centre of the liner. A small selection of some of the more common designs is illustrated in Figure 1.

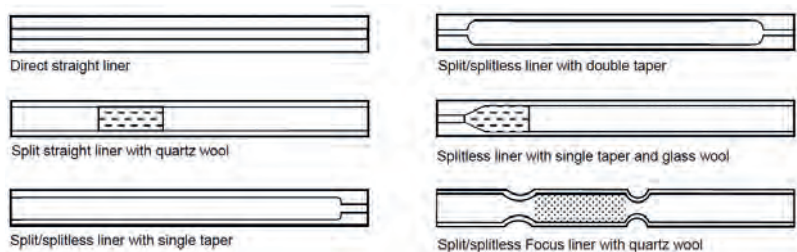

Figure 1. Selection of GC inlet liners

Septa

Septa are available for a variety of different applications and different temperature ranges. Lower temperature septa are generally softer, seal better and can withstand more injections than their higher temperature counterparts. General purpose silicone rubber septa are cost-effective choices, providing low bleed, long lifetime and easy penetration. BTO (Bleed and Temperature Optimized) septa have an extended upper temperature range of 400°C and are ideal for use with low-bleed 'MS' type capillary columns. Various other septa types including PTFE coated silicone, PTFE multi-layer silicone and pre-pierced septa are available. Please enquire for further details.



Ferrules

A comprehensive selection of ferrules is available, made of different materials and configurations for a leak-free connection between the column and the injector. Four main types of ferrules are used with capillary GC columns – graphite, vespel/graphite composites, vespel and stainless steel.

1) Graphite ferrules can be used at temperatures up to 450°C without producing bleed or decomposition products. They are very soft and porous to oxygen, making them suitable for most applications except GC-MS connections.

2) Vespel/graphite (85%/15%) ferrules are mechanically robust, have a long lifetime and are compatible with GC-MS. As they form a strong grip with the column, they cannot be re-used.

3) Vespel is a high temperature polyimide material which is very hard. It has low oxygen permeability making it an excellent sealing material. Vespel ferrules are reusable but are suitable for isothermal operation only.

4) SilTite™ stainless steel ferrules form strong permanent airtight seals with capillary column and MS interface. Unlike other ferrules they do not need re-tightening after installation.



100% Graphite ferrules



SilTite metal ferrules

The properties of these materials are summarised in Table 1.

Table 1

Material	Upper Temp. Limit	Suitable for GC-MS	Re-usable
Graphite (100%)	450°C	No	Yes
Vespel/Graphite (85%/15%)	350°C	Yes	No
Vespel	280°C	Yes	Yes
Stainless steel (SilTite™)	500°C	Yes	No

Please contact Hichrom for ordering information for inlet liners, septa and ferrules and for information on any additional GC accessories.

DIGITAL FLOW METER

- Handy and compact
- Wide flow rate range
- Easy to operate

Accurate gas flow measurement is a fundamental requirement for consistent and reliable gas chromatographic results. The GLF-1000 flow meter, manufactured by GL Sciences, measures target gases accurately and safely. The GLF-1000 is based on differential pressure (DP) measurement. Target gas flows up to 1000ml/min can be easily measured. The GLF-1000 operates off a simple 9V battery.

Specifications:

Gases	Helium, nitrogen, hydrogen, air
Range	1 – 1000ml/min
Accuracy (He)	± 10% of flow reading or ± 0.8ml/min whichever is greater (for 5 – 50ml/min) ± 5% of flow reading (for 50-900ml/min)
Temperature Range	5 - 40°C
Battery	9 volt square battery (1 pc)
Dimensions	80 (W) x 145 (D) x 38.5 (H) mm
Weight	180g excluding battery
Others	Auto power off function Battery monitor function CE certified

Ordering Information

Description	Catalogue No.
Digital flow meter GLF-1000	2709-11000
Capillary column connecting adaptor	2709-55015



GAS LEAK DETECTOR

- Super compact
- High sensitivity
- Easy to use
- USB port recharge

GL Sciences' LD239 gas leak detector utilises thermal conductivity measurements between target and reference gases. The LD239 is small, light and very sensitive. It detects up to 0.0005ml/min of helium gas, and can easily be recharged anywhere using the USB port connection.

Specifications:

Detection Method	Thermal conductivity
Target Gases	Helium, CO ₂ , Ar, Ne etc
Sensitivity (He)	0.005ml/min at minimum (standard range) 0.0005ml/min at minimum (high range)
Display	LCD
Temperature Range	10 - 40°C
Battery	Lithium ion battery installed, rechargeable through a USB port, 2.5 hours for full recharge. 5 hour battery life with continuous use.
Dimensions	50 (W) x 20 (D) x 111 (H) mm
Weight	95g
Accessories included	USB cable (1m), sample gas filter (probe built-in), referential gas filter (built-in), instruction manual, warranty certificate



Ordering Information

Description	Catalogue No.
Gas leak detector LD239	2702-19340
Replacement Accessories	
Battery for LD239	2702-19341
USB cable	2702-19331
Sample filter	2702-19333
Reference filter	2702-19334

FunCap®-CE Series

- High reproducibility of migration time
- Fast analysis
- Compatible with wide pH range

GL Sciences manufacture the FunCap®-CE series of chemically modified fused silica capillaries. General purpose FunCap-CE capillaries are 1m in length, but with the detection window, have an effective length of 0.75m. For CE-MS, capillaries are 1.5m, with no detection window. Four types of chemical modifications are available. In addition, the FunCap-CE-V series capillaries, with high quality and performance, are available with an inspection report on the reproducibility of migration times.

FunCap-CE Type A The internal surface of the fused silica tubing is chemically modified by cationic groups. The electroosmotic flow (EOF) runs from anode to cathode, independent of pH, enabling usage in the pH range below 7.0. Type A capillary columns are suited for the analysis of cationic compounds.

FunCap-CE Type S The internal surface of the fused silica tubing is chemically modified by anionic groups. The EOF runs from cathode to anode, independent of pH, enabling usage in a wide pH range below 9.0.

FunCap-CE Type D This capillary is chemically modified by polar functional groups, resulting in less adsorption of proteins and therefore reduced deterioration of the capillary column surface.

FunCap-CE Type C In addition to lower protein adsorption, Type C capillary columns provide fast electroosmotic flow for protein analyses. These capillaries are suited for the analyses of acidic and neutral proteins.

Bare fused silica and deactivated fused silica capillaries are also available – please enquire for details.

Ordering Information

Description ¹	Capillary Length (m)	Type A	Type S	Type D	Type C
For CE (with detection window)	1.0	1010-33012	1010-33010	1010-33013	1010-33011
For CE-MS (without detection window)	1.5	1010-33022	1010-33020	1010-33023	1010-33021
		Type A-V	Type S-V	Type D-V	Type C-V
For CE-MS (without detection window)	1.0	1010-33032	1010-33030	1010-33033	1010-33031
	1.5	1010-33042	1010-33040	1010-33043	1010-33041

¹ All capillaries are 0.05mm i.d. and 0.375mm o.d.

MicroSolv CE Capillaries

MicroSolv Technology Corporation manufactures several ranges of capillaries for CE.

Simplus Capillaries™ These bare fused silica capillaries are 365µm (0.375mm) o.d. and available in 1m, 10m or 25m lengths.

Zero™ EOF Capillaries These are neutral coated capillaries designed to eliminate EOF and minimize wall interaction. They are suited to analysis of proteins, peptides or basic molecules.

Celerity CE™ Capillaries These have etched internal walls which increase surface area. Bonded phases include C18, C8, Diol, Butylphenyl and Cholesterol. Applications include hard to separate proteins, peptides or small molecules.

Controlled™ EOF Capillaries These capillaries are pH independent, so that the EOF does not change when the pH of the buffer is changed, encouraging reproducible CE and long capillary lifetime.

Please contact Hichrom for further technical details and ordering information on MicroSolv CE capillaries.

Detection Window Maker™

The detection Window Maker™ from MicroSolv is easy to use for all capillaries for CE. It can be used to remove 1-2mm of the polyimide coating from 365µm o.d. capillaries for detection by UV and LIF. The Window Maker is shipped with a standard 2mm module for burning the capillary.

Description	Catalogue No.
Window Maker, 220/240 VAC, EU with 2mm module ¹	07300-S
Replacement heating module, 2mm window	07201-S

¹ Other size heating modules available – please enquire



SOLID PHASE EXTRACTION

- High recovery and concentration of analytes
- Highly purified extracts
- Fast sample preparation
- Ease of automation
- Reduction in organic solvent consumption

Effective sample preparation procedures improve analytical results irrespective of the final analytical technique used.

Solid Phase Extraction (SPE) is a powerful technique for sample preparation. It is used in a broad range of application areas, including environmental analyses, pharmaceutical and biochemical analyses, organic chemistry and food analyses.

SPE utilises a liquid-solid extraction separation principle in which a large particle sized sorbent is sealed into a small chromatographic column. The required analytes are then selectively removed from the column either before or after removal of interfering compounds.

The main objectives of SPE are removal of interfering matrix components and selective concentration and isolation of the analytes of interest. This enables improved qualitative or quantitative analyses by GC, HPLC or other chromatographic techniques. Enrichment can increase detection sensitivity by a factor of 100 to 5000, which is particularly beneficial for trace analyses. Figures 1 and 2 below illustrate the two general separation procedures.

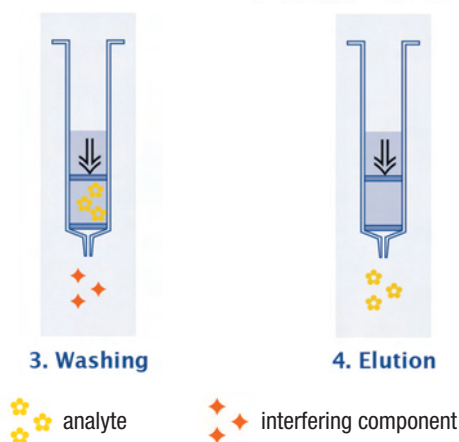
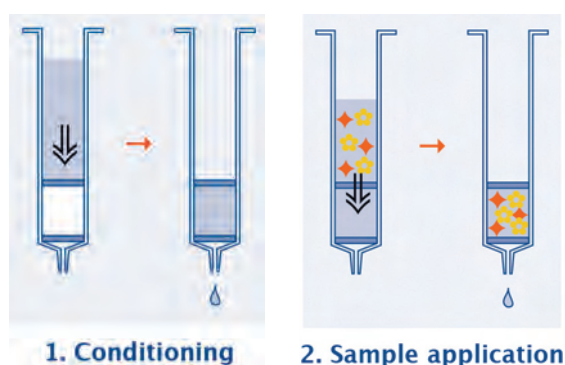

Figure 1. Retention of the analyte

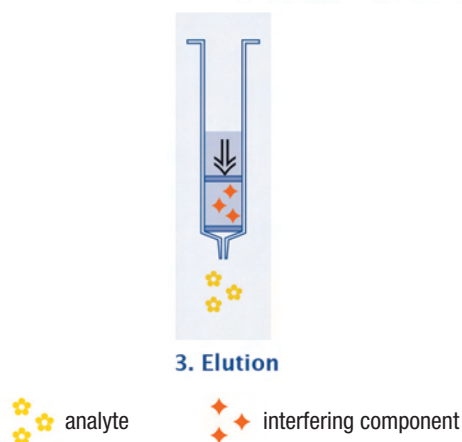
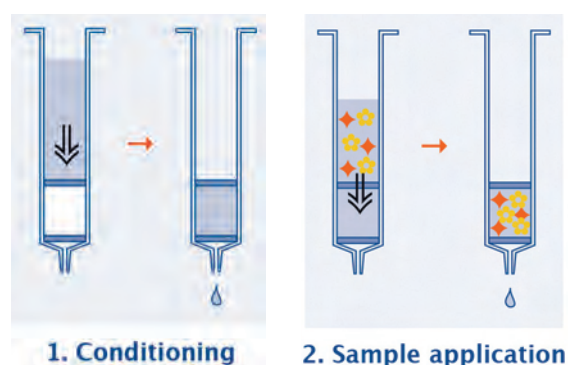

Figure 2. Retention of the interfering components

Retention of the analyte

- Analyte molecules are enriched on the adsorbent
- Interfering components and solvent molecules (matrix) are not retained
- Remaining interfering components are washed from the adsorbent
- The analyte is removed from the adsorbent by elution with a suitable solvent

Retention of interfering components

- Analyte molecules show no interaction with the adsorbent
- Interfering components and solvent molecules (matrix) are retained
- Analyte molecules are 'washed' from the adsorbent
- The solid phase is simply used to 'filter' the sample

Hichrom offers several ranges of SPE products –
please contact us to discuss your application requirements

GL Sciences offer the Smart Bag series of sampling bags, based on a range of materials and dimensions, suitable for different target compounds. Sampling bags are widely used as a convenient sampling method for automobile interior materials, automobile emissions, work environments, building materials and textiles. Gas samples collected can be directly injected into a gas chromatograph. These bags are an ideal accessory for applications involving MonoTrap sampling.

Sampling Bags

Description	Material	Temperature Limit (°C)	Film Thickness (µm)	Properties	Applications
Smart Bag PA	Vinyl alcohol polymer film	120	53	Superior resistance to solvents, heat and permeation	Automobile interior materials, automobile emissions, diffusion gases from materials, inorganic gases
Smart Bag 2F	Polyvinylidene fluoride (PVDF) film	120	50	Superior resistance to solvents and heat	Automobile interior materials, automobile emissions, diffusion gas from materials
ANALYTIC-BARRIER™ Bag	Proprietary	70	45	Good resistance to permeation, low background	Automobile interior materials, inorganic gases
Fluororesin Bag	Ethylene-tetrafluoroethylene copolymer film	110	50	Good resistance to solvents and heat	Organic solvents
Aluminium Bag	Laminated film ¹	65	130	Good permeation resistance to inorganic gas, methane	Inorganic gases
Polyester Bag	Polyester film	n/a	38	Good permeation resistance to VOCs	Volatile organic compounds (VOCs), odour analysis

¹ From outer: nylon, polyethylene, aluminium foil, polyethylene

Selection of Sampling Bag

In order to achieve highly reliable test results, the appropriate sampling bag should be chosen depending on the target compounds required to be collected. The following parameters need to be selected:

- 1) Material** – The range of materials used in the Smart Bag product line is summarised in the table above. The choice of material is important, in order to optimise adsorption and to minimise interference from background peaks.
- 2) Shape** – Three configurations (A, C and E) are available - see Figure 1.
- 3) Connector (PTFE)** – Different diameter sleeves, with or without mini valves or M6 connectors, can be incorporated (see Figure 2).
- 4) Volume** – 1, 2, 3, 5 and 10 litre volume bags are available as standard. Other sizes are available on request.

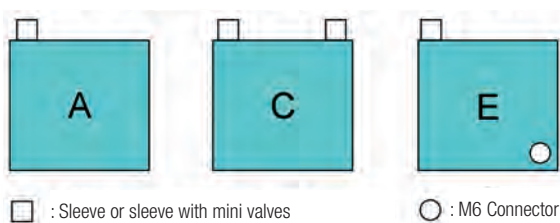

□ : Sleeve or sleeve with mini valves

○ : M6 Connector

Figure 1. Configurations of Smart Bags



Figure 2. Connectors

Smart Bag PA

Smart Bag PA, made from vinyl alcohol series polymer film, is one of the most popular sampling bags. It shows excellent resistance to solvents and heat, and very few impurities are generated from the material. Smart Bag PA also avoids the permeation of O₂ or CO₂. This enables a wide range of sampling from inorganic to organic gases.

Please contact Hichrom for further details and ordering information for these sampling bags.



Smart Bag PA



Automobile interior materials



Environmental air



Automobile emissions



Work environment

PIPETTE TIPS

- Simple, fast sample preparation with minimal sample loss
- No contamination from supporting matrix
- Sample volumes as small as 0.1 μl

A range of micropipette tips is manufactured by Glygen Corporation for the preparation and separation of biological samples for HPLC, MALDI, CE, desalting and electrophoresis. In addition to non-bonded silica and reversed-phase materials, NuTips and TopTips are available packed with PolyLC ion-exchange materials (see pages 127-130) or with titania, zirconia, graphitic carbon and affinity media.

NuTip™

NuTip™ enables purification of low concentration or low volume samples by maximising the surface area in contact with the sample. The chromatographic media is directly attached to the inner surface of the pipette tip without using polymers or glue. This helps avoid potential problems with contamination or permeability. Figure 1 shows the basic operating principles of purification using NuTips.

Specifications

Tip Volume (μl)	Sample Volume (μl)	Binding Capacity (μg)	Amount Chromatographic Material (mg)
1 - 10	0.5 - 10	1	30
10 - 200	2 - 25	2.5	75
20 - 200	5 - 50	15	400



NuTip

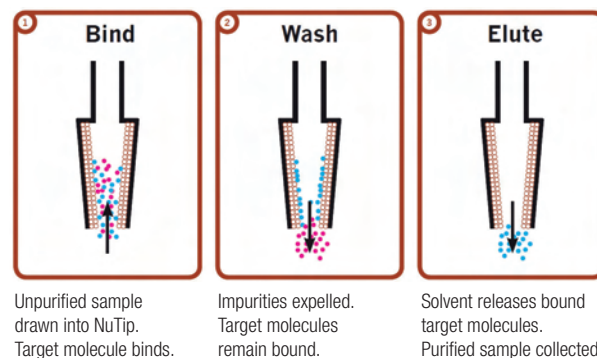
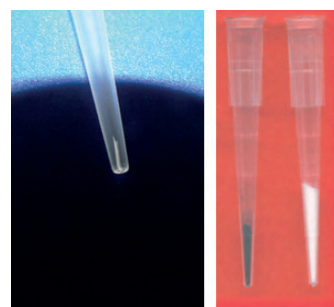

Figure 1. Basic operating principles of NuTip



TopTip

TopTip™

TopTip™ is a pipette tip with a fine slit (1-2 μm) at the bottom which enables liquid to pass through but retains chromatographic material (20-30 μm) in the tip. This eliminates the need for a filter, thereby reducing dead volume, loss of sample and contamination risk. Pressure can be applied via centrifuge, pipette, syringe or vacuum manifold. Figure 2 shows the basic operating principles of purification using TopTips.

Specifications

Tip Volume (μl)	Sample Volume (μl)	Binding Capacity (μg)	Amount Chromatographic Material (mg)
1 - 10	1 - 10	400	4
10 - 200	2 - 25	1000	10
100 - 1000	20 - 1000	5000	50

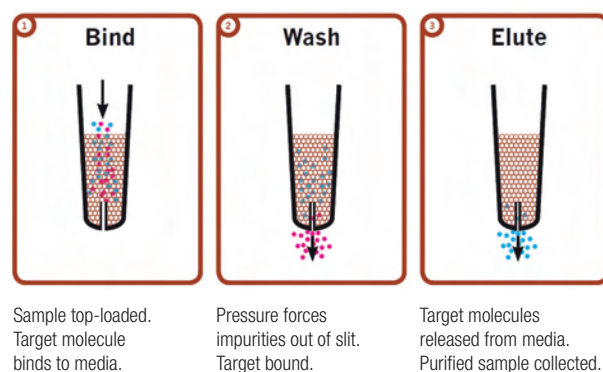

Figure 2. Basic operating principles of TopTip

Both NuTip and TopTip products are available packed with a range of materials to suit a wide range of applications. Please enquire for further details.

- Extended solvent compatibility
- Colour coded or colour free labelled
- Low dead volume
- Well suited for automation
- Star-shaped distribution device

CHROMAFIL® disposable syringe filters are used for filtration of suspended matter from liquid samples (1 – 100ml) or gases. This is important for preventing column or frit blockage and wear to valve seals. The filters connect to standard Luer hub syringes.

These filters are available in a broad range of pore sizes and membrane types. The polypropylene housings are highly solvent resistant and exhibit low extractables.

CHROMAFIL Xtra syringe filters are labelled for method validation and certification. They are imprinted for direct identification of the membrane type, diameter and pore size. They are manufactured in colour-free polypropylene and HPLC test certificates are available for every membrane type. CHROMAFIL Xtra are suitable for use in automated instrumentation. Please enquire for further details and ordering information.



Recommended filter sizes for different sample volumes

Sample Volume	Recommended Diameter	Dead Volume
<1ml	3mm	5µl
1 – 5ml	15mm	12µl
5 – 100ml	25mm	<80µl

Ordering Information²

CHROMAFIL Type	Membrane Pore Size (µm)	Membrane Diameter (mm)	Catalogue No.	Pack Size ¹	Recommended Applications
Cellulose mixed esters (MV)					
A-20/25	0.20	25	729006	100	Filtration of polar sample solutions
A-45/25	0.45	25	729004	100	
Cellulose acetate (CA)					
CA-20/25 S	0.20	25	729024	50	Filtration under sterile conditions
CA-45/25 S	0.45	25	729025	50	
CA-20/25	0.20	25	729026	100	Filtration of water soluble oligomers and polymers, especially biological macromolecules
CA-45/25	0.45	25	729027	100	
Regenerated cellulose (RC)					
RC-20/15 MS	0.20	15	729036	100	Filtration of polar and medium polar sample solutions (MS = minispikes on filter exit)
RC-45/15 MS	0.45	15	729037	100	
RC-20/25	0.20	25	729030	100	
RC-45/25	0.45	25	729031	100	
Polyamide (PA)/Nylon					
AO-20/3	0.20	3	729010	100	Filtration of medium polarity sample solutions
AO-45/3	0.45	3	729011	100	
AO-20/25	0.20	25	729012	100	
AO-45/25	0.45	25	729013	100	
Polytetrafluoroethylene (PTFE)					
O-20/3	0.20	3	729014	100	Filtration of nonpolar sample solutions. Flush with alcohol for polar sample solutions. (MS = minispikes on filter exit)
O-45/3	0.45	3	729015	100	
O-20/15 MS	0.20	15	729008	100	
O-45/15 MS	0.45	15	729009	100	
O-20/25	0.20	25	729007	100	
Polyvinylidene difluoride (PVDF)					
PVDF-20/15 MS	0.20	15	729043	100	Filtration of polar and nonpolar solutions (MS = minispikes on filter exit)
PVDF-45/15 MS	0.45	15	729044	100	
Polyester (PET)					
PET-20/15 MS	0.20	15	729022	100	Multi-purpose membrane for polar and nonpolar solutions, especially suited for mixtures of water and organic solvents used as eluents in HPLC (MS = minispikes on filter exit)
PET-45/15 MS	0.45	15	729023	100	
PET-20/25	0.20	25	729021	100	
PET-45/25	0.45	25	729020	100	
Glass fibre (GF)					
GF-100/15 MS	1.0	15	729034	100	For solutions with a high load of particulate matter and highly viscous solutions (MS = minispikes on filter exit)
GF-100/25	1.0	25	729028	100	
Glass fibre (GF)/Polyester (PET)					
GF/PET-20/25	1.0/0.20	25	729032	100	For solutions with a high load of particulate matter and highly viscous solutions (MS = minispikes on filter exit)
GF/PET-45/25	1.0/0.45	25	729033	100	

¹ BIG BOX (400/pk for 25mm filters and 800/pk for 15mm filters) also available – please enquire

² Please enquire for ordering information for CHROMAFIL Xtra syringe filters

TLC PLATES

- Economical separation method
- High sample throughput
- Pilot procedure for HPLC and flash chromatography
- Versatile range of ready-to-use layers

Thin layer chromatography (TLC) is a simple, fast and highly versatile separation tool for both qualitative and quantitative analyses. The areas of application cover virtually all classes of compounds. About 80% of all TLC separations are performed using unmodified silica as the separation medium. Other commonly used adsorbents include modified silica, aluminium oxide and cellulose. Silica has the advantage of being able to use thicker layers (up to 2mm), suitable for preparative TLC.

Macherey-Nagel TLC Plates

Macherey-Nagel offers a wide selection of TLC plates. In addition to glass plates, flexible plates are available on aluminium sheets (ALUGRAM®) and polyester sheets (POLYGRAM®). These are more economical than glass plates and have the advantage of being easy to cut. ALUGRAM Xtra aluminium sheets exhibit outstanding wettability even with 100% aqueous eluents. They also show improved cutting properties due to an optimised binder system. TLC plates produced by Macherey-Nagel are coated with the same silica used for Macherey-Nagel flash products.

The properties of a range of unmodified silica adsorbents for TLC and HPTLC are summarised below.

Standard unmodified silica	
SIL G	Silica 60, standard grade, particle size 5-17µm
ADAMANT	Silica 60, improved binder system, optimised particle size distribution
DURASIL	Silica 60, special binder system, more polar than SIL G
SIL N-HR	High purity silica 60, special binder system, higher gypsum content
SILGUR	Silica 60 with kieselguhr concentrating zone
Unmodified silica for HPTLC	
Nano-SIL	Nano silica 60, standard grade, particle size 2-10µm
Nano-ADAMANT	Nano silica 60, optimised binder system and particle size distribution
Nano-DURASIL	Nano silica 60, special binder system
Nano-SILGUR	Nano silica 60, with kieselguhr concentrating zone

SIL G

Standard grade silica (SIL G) has a pore size of 60Å and a particle size of 5-17µm. The binder is stable in almost all organic solvents and resistant towards aggressive visualisation reagents.

ADAMANT

ADAMANT glass TLC plates are based on standard grade silica 60, with optimised particle size distribution for increased separation efficiency, and an improved binder system resulting in outstanding hardness and abrasion resistance. They are suitable for trace analyses due to a UV indicator with increased brilliance and a low background noise.

Nano Silica HPTLC (Nano-SIL) Plates

For high performance TLC separations, the same silica 60 is used, but with a particle size distribution of 2-10µm. This narrower particle size fractionation allows sharper separations, shorter development times, shorter migration distances and increased detection sensitivity compared to SIL G plates.

TLC and HPTLC Plates with Concentrating Zone (SILGUR and nano-SILGUR)

Plates with concentrating zones are a valuable aid for manual sample application. The kieselguhr concentrating zone is completely inert towards a large number of compounds. Samples always form a narrow band at the interface of the silica and kieselguhr adsorbents, irrespective of shape, size or position of the spots in the concentrating zone (see Figure 1). Separation then takes place in the silica layer.

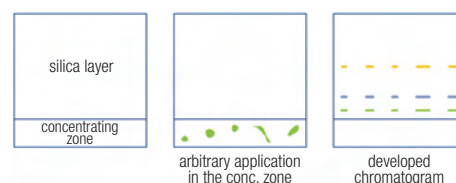

Figure 1. TLC plate with concentrating zone

Modified Silica Layers

Although the majority of TLC separations are performed on unmodified hydrophilic silica, reversed-phase TLC plates are also available. These are prepared by total (100%) or partial (50%) bonding of C18 groups to the nano silica (2-10µm, 60Å). Nano-SIL CN, NH₂ and Diol are also available – please contact Hichrom for details.

Other Adsorbents

A range of aluminium oxide and cellulose adsorbent TLC plates are available as glass plates, or polyester or aluminium sheets. In addition, a range of alternative adsorbents for specific applications is offered.

Ordering information for unmodified silica plates for TLC and HPTLC is given on the following page. Please contact Hichrom for details of TLC and HPTLC plates with modified silica or other adsorbents.

Macherey-Nagel TLC Plates (continued)

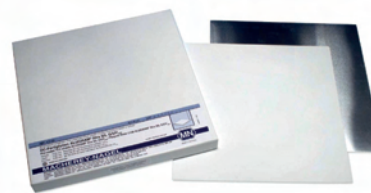

Ordering Information

Standard Silica (SIL G) TLC plates

Description	Layer (mm)	Plate Size ¹ (cm)	Pack Size	Cat. No.
Glass plates				
SIL G-25	0.25	5 x 10	50 ²	809017
SIL G-25	0.25	5 x 20	100	809011
SIL G-25	0.25	10 x 20	50	809012
SIL G-25	0.25	20 x 20	25	809013
SILGUR-25	0.25	10 x 20	50	810012
SILGUR-25	0.25	20 x 20	25	810013
POLYGRAM polyester sheets				
SIL G	0.20	4 x 8	50	805032
SIL G	0.20	5 x 20	50	805012
SIL G	0.20	20 x 20	25	805013
ALUGRAM aluminium sheets				
SIL G	0.20	5 x 10	50	818161
SIL G	0.20	10 x 20	20	818163
SIL G	0.20	20 x 20	25	818033
ALUGRAM Xtra aluminium sheets				
SIL G	0.20	5 x 10	50	818261
SIL G	0.20	5 x 20	50	818232
SIL G	0.20	20 x 20	25	818233
SILGUR	0.20	10 x 20	20	818412
SILGUR	0.20	20 x 20	25	818413

¹ Other dimension plates available² Other pack sizes available

Standard Silica (SIL G) TLC plates with UV indicator

Description	Layer (mm)	Plate Size ¹ (cm)	Pack Size	Cat. No.
Glass plates				
SIL G-25 UV ₂₅₄	0.25	5 x 10	50 ²	809027
SIL G-25 UV ₂₅₄	0.25	5 x 20	100	809021
SIL G-25 UV ₂₅₄	0.25	10 x 20	50	809022
SIL G-25 UV ₂₅₄	0.25	20 x 20	25	809023
SILGUR-25 UV ₂₅₄	0.25	10 x 20	50	810022
SILGUR-25 UV ₂₅₄	0.25	20 x 20	25	810023
POLYGRAM polyester sheets				
SIL G/UV ₂₅₄	0.20	4 x 8	50	805021
SIL G/UV ₂₅₄	0.20	5 x 20	50	805022
SIL G/UV ₂₅₄	0.20	20 x 20	25	805023
ALUGRAM aluminium sheets				
SIL G/UV ₂₅₄	0.20	5 x 10	50	818160
SIL G/UV ₂₅₄	0.20	10 x 20	20	818162
SIL G/UV ₂₅₄	0.20	20 x 20	25	818133
ALUGRAM Xtra aluminium sheets				
SIL G/UV ₂₅₄	0.20	5 x 10	50	818360
SIL G/UV ₂₅₄	0.20	5 x 20	50	818332
SIL G/UV ₂₅₄	0.20	20 x 20	25	818333
SILGUR UV ₂₅₄	0.20	10 x 20	20	818422
SILGUR UV ₂₅₄	0.20	20 x 20	25	818423

Nano-SIL TLC plates

Description	Layer (mm)	Plate Size ¹ (cm)	Pack Size	Cat. No.
Glass plates				
Nano-SIL-20	0.20	5 x 5	100	811011
Nano-SIL-20	0.20	10 x 20	50	811013
Nano-SILGUR-20	0.20	10 x 10	25	811032
ALUGRAM aluminium sheets				
Nano-SIL G	0.20	20 x 20	25	818141
ALUGRAM Xtra aluminium sheets				
Nano-SIL G	0.20	5 x 20	50	818240
Nano-SIL G	0.20	20 x 20	25	818241
Nano-SILGUR	0.20	10 x 10	25	818432

¹ Other dimension plates available

Nano-SIL TLC plates with UV indicator

Description	Layer (mm)	Plate Size ¹ (cm)	Pack Size	Cat. No.
Glass plates				
Nano-SIL-20 UV ₂₅₄	0.20	5 x 5	100	811021
Nano-SIL-20 UV ₂₅₄	0.20	10 x 20	50	811023
Nano-SILGUR-20 UV ₂₅₄	0.20	10 x 10	25	811042
ALUGRAM aluminium sheets				
Nano-SIL G/UV ₂₅₄	0.20	20 x 20	25	818143
ALUGRAM Xtra aluminium sheets				
Nano-SIL G/UV ₂₅₄	0.20	5 x 20	50	818342
Nano-SIL G/UV ₂₅₄	0.20	20 x 20	25	818343
Nano-SILGUR UV ₂₅₄	0.20	10 x 10	25	818442

ADAMANT Silica TLC plates (glass)

Description	Layer (mm)	Plate Size ¹ (cm)	Pack Size	Cat. No.
ADAMANT	0.25	5 x 10	50 ²	821040
ADAMANT	0.25	10 x 10	25	821050
ADAMANT	0.25	20 x 20	25	821060

¹ Other dimension plates available² Other pack sizes available

ADAMANT Silica TLC plates (glass) with UV indicator

Description	Layer (mm)	Plate Size ¹ (cm)	Pack Size	Cat. No.
ADAMANT UV ₂₅₄	0.25	2.5 x 7.5	100	821005
ADAMANT UV ₂₅₄	0.25	5 x 10	50 ²	821010
ADAMANT UV ₂₅₄	0.25	10 x 10	25	821020
ADAMANT UV ₂₅₄	0.25	10 x 20	50	821025
ADAMANT UV ₂₅₄	0.25	20 x 20	25	821030

Merck Millipore TLC Plates

Merck Millipore offer a wide range of classical TLC plates for manual operation and HPTLC (High Performance TLC) plates for automated operations. Merck Millipore introduced the first pre-coated plates on the market. TLC plates in a wide range of chemistries, sizes and backing materials, to suit a variety of applications, are offered. The features of a selection of these plates are summarised below.

Classical Silica TLC Plates. These are based on Merck silica gel with a pore size of 60Å and surface area of 520m²/g. Classical silica TLC plates have a layer thickness of 250µm (glass plates) or 200µm (aluminium or plastic backed plates) and a mean particle size of 10-12µm.

Applications: Wide range

High Performance Silica Plates (HPTLC). Merck HPTLC plates offer higher speed and higher sensitivity than classical TLC plates. They utilise optimised silica gel 60 with a particle size of only 5-6µm and thinner layers (<200µm). Glass or aluminium backed plates, with or without fluorescent indicator are available.

Applications: Identity testing in analysis of herbal medicines, quantitative QC separations of drugs, trace analysis in food

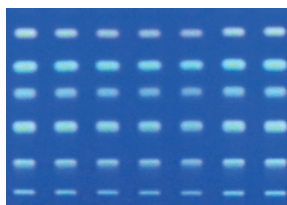

A. Classical TLC silica gel 60 plate

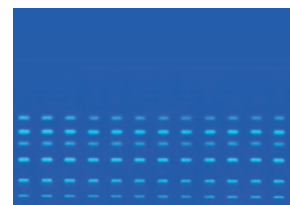

B. HPTLC silica gel 60 plate

LiChrospher® HPTLC Plates. LiChrospher® HPTLC plates are based on spherical silica particles (60Å pore size, 7µm particle size), for the ultimate TLC performance, speed and sensitivity, enabling high throughput analysis of complex samples. They enable lower detection limits and higher resolution to be achieved, compared to TLC.

Applications: Complex low concentration samples eg. pesticide mixtures, pharmaceuticals

RP-Modified Silica Plates (TLC and HPTLC). RP-modified (RP-2, RP-8 or RP-18) silica layers are suitable for separations insufficiently resolved on unmodified silica. Glass and aluminium backed plates are available.

Applications: Amides, antibiotics, fatty acids, non-polar substances using aqueous solvents

CN-, Diol- and NH₂-Modified Plates (TLC and HPTLC). These are less polar than the classical silica phases and therefore suited for the separation of hydrophilic or charged substances. The amino modified plates offer an alternative to PEI cellulose.

Applications: CN-silica – benzodiazepines, pesticides, plasticisers, tetracyclines, antibiotics

Diol-silica – glycosides, anabolic steroids, aromatic amines, dihydroxybenzoic acids

NH₂-silica – charged compounds eg. nucleotides, phenols, sulphones

Aluminium Oxide TLC Plates. These TLC plates utilise neutral or basic aluminium oxide of 60Å or 150Å pore size, with or without fluorescence indicator to suit different application needs. Under aqueous conditions basic compounds are best separated on basic aluminium oxide plates, while neutral compounds are best separated on neutral plates.

Cellulose Plates (TLC and HPTLC). Cellulose plates are ideal for separating hydrophilic compounds by partition chromatography. Glass, aluminium and plastic backed TLC plates as well as glass and aluminium backed HPTLC plates are available.

Applications: Amino acids, carbohydrates, phosphates, nucleic acids and nucleic acid derivatives

PEI (Polyethyleneimine) Cellulose Plates. PEI modified cellulose acts as a strong basic anion-exchanger.

Applications: Amino acids, peptides, nucleotides, nucleosides, sugar phosphates

Concentrating Zone Plates (TLC, HPTLC, PLC). Merck's concentrating zone plates are based on the different adsorption properties of two adsorbents. The first is a large pore concentrating adsorbent where the samples are applied; the second is a selective layer for separation. Regardless of the spots' shape, size, or position, the sample always concentrates as a narrow band where the two adsorbents overlap and where the separation starts.

Mixed Layer Plates. Merck's mixed layer plates utilise a combination of classical silica gel 60 and kieselguhr, to provide good separation properties for certain special applications.

Applications: Inorganic ions, herbicides, some steroids

Preparative Layer Plates (PLC). PLC plates allow the separation of mg to gram samples using up to 2mm thick layers on glass backed plates. Plates are available with layers of silica gel, RP-18 modified silica or aluminium oxide in several layer thicknesses (0.5mm to 2mm), with or without fluorescent indicator.

Please contact Hichrom for further details and ordering information for the above products and alternative TLC plates and accessories not listed.

- Detect low abundance analytes normally adsorbed by glass
- Prevent pH changes in vials before injection
- Prevent sample hydrolysis that can occur in vials
- Excellent choice for LC, LC-MS, LC-MS/MS, GC and GC-MS

RSA Glass™ vials and inserts, supplied by MicroSolv Technology Corporation, are manufactured using a revolutionary patented production process that virtually eliminates all silanols and produces glass which has a greatly reduced surface activity for basic compounds. RSA Glass vials are not coated or silanised. The reduced surface activity of these vials makes them an excellent choice for many applications, including biologicals, natural products and basic compounds, or when accurate quantitation is vital.

Why use RSA vials?

- **If you are working with low abundance basic samples** with regular glass vials, your components could easily be adsorbed to the glass wall. This can change your quantitation or completely remove the compound from solution preventing injection and ultimately masking its detection and identification. With RSA Glass vials and inserts this will not occur if the adsorption is due to silanol interaction.
- **If you are working with sensitive compounds** commonly found in natural products, biological samples or chemical synthesis, the glass wall could be a problem for basic compounds. With RSA Glass vials this problem is eliminated.
- **If you are working with basic proteins** that adsorb or are affected by silanols, inert RSA Glass vials will be a good solution. In addition, if silanisation is required for very 'sticky' proteins and peptides, the results are superior with RSA Glass over standard borosilicate glass.



Manufacture of Conventional Glass Vials

When vials are made, they are constructed from long lengths of borosilicate glass tubing, made to exact tolerances and chemical specifications. This tubing is placed into vial converting machines that use heat to tool the tubing into vials and give them the dimensional characteristics such as necks, threads and bottoms. During this process, the intense heat that is used can often cause some of the glass to become a gas, which will quickly cool and sublimate onto the surface of the vial in the form of a silicate material. This material is not covalently bonded to the glass and will vary in amount from vial to vial and lot to lot, depending on the amount of heat used.

This 'silicate' material is pH sensitive, adsorbs basic compounds and will 'delaminate' or come off the vial under some conditions.

Potential Problems When Using Ordinary Borosilicate Glass Vials

When using ordinary borosilicate glass autosampler vials and inserts, sample diluents such as water can deprotonate the many hydroxyl groups on the wall of the vial, which produces a negative charge on the glass. The acidic functionality of these silanols can cause adsorption of basic compounds, change the pH of the sample solution and/or hydrolyse susceptible compounds making them undetectable.

Manufacture of RSA Glass Vials

RSA Glass vials are manufactured in the same manner as conventional borosilicate glass vials, except that the proprietary process of precision heat control is used to virtually eliminate the gaseous state formation. Therefore, there is no silicate layer formed and subsequently the problems associated with it are removed.

To maintain the quality and integrity of these vials, they are immediately packaged by robotic arms in a Class 100,000 clean room and are never touched by human hands.



Metal Levels

RSA Glass has been tested for metals that may cause sample or diluent contamination. It has ultra low levels of sodium, calcium, aluminium and boron. Sodium and boron levels are 200 to 300 times less concentrated compared to leading manufacturers' vials, with calcium and aluminium almost undetectable. Testing was carried out with ICP using water from the vials which had had a 4 hour 'soak' time.

Advantages of RSA™ Vials

Table 1 illustrates the advantages of RSA™ vials compared to conventional borosilicate HPLC and GC autosampler vials with regard to sample adsorbance and pH changes. For the sample adsorption test a 5µg/ml aqueous solution of chlorhexidine was used. After 4 hours in the vials, the final concentrations and concentration losses were determined for each brand of vial in the study. MicroSolv have demonstrated that the conventional borosilicate glass vials Brand X and Brand Y showed considerable loss of sample over the 4 hours of the study. The benefits of using RSA vials to minimise sample adsorption to the glass can clearly be seen.

The pH test used deionised water at pH 5.45 (see starting point value in Table 1). After a 4 hour test period, the sample solution in the RSA vials showed no change in pH, whereas Brand X and Brand Y vials showed changes of ≥ 1.25 pH units.

Table 1. Adsorption and pH changes¹

Brand	Ave. % loss after 4 hrs ²	pH
Starting Point	0	5.45
RSA Glass	0.35	5.50
MicroSolv Brand	17.62	6.15
Brand X	54.14	6.65
Brand Y	45.96	6.94

¹ Data courtesy of MicroSolv Technologies, USA. The comparative data presented here may not be representative for all applications

² Average of 3 vials

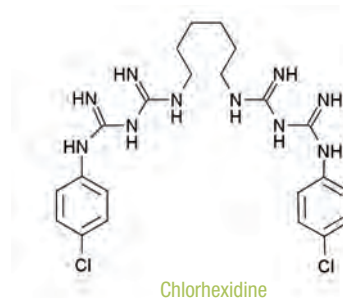

In a further study seven test solutes containing different functional groups were assayed by HPLC in commonly used conventional borosilicate and RSA glass autosampler vials over a 4 hour period. Table 2 indicates that analytes with no basic group showed no loss of peak area during this time for either vial type. The greatest losses due to adsorption to the glass occurred for basic compounds, in particular for the cationic amines thiamine and cetylpyridinium chloride.

Table 2. Percent loss after 4 hours¹

Analyte	Regular Glass	RSA Glass
1. Benzoic acid	0	0
2. Phenol	0	0
3. Pyridine	3.5	0.2
4. 4-Amino-3-chloropyridine	9.1	0.6
5. Mepyramine	13.1	0.7
6. Thiamine	32.6	3.1
7. Cetylpyridinium chloride	52.7	9.8

¹ Data courtesy of MicroSolv Technologies, USA. The comparative data presented here may not be representative for all applications

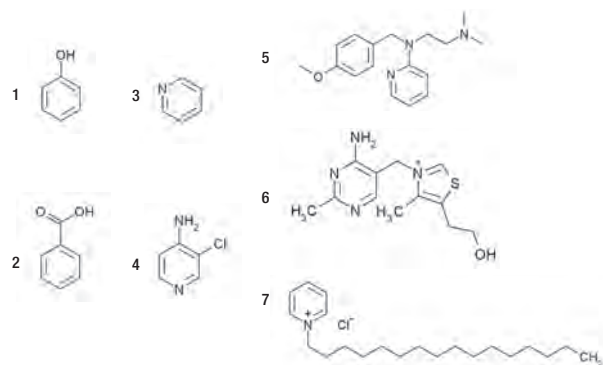

This effect is more significant at lower concentrations. Figure 1 shows the percent recovery for different concentrations of cetylpyridinium chloride solutions after 4 hours using both vial types. Although only a small difference is seen between regular glass and RSA glass vials at the highest concentration studied (100ppm), at the lowest 5ppm level the discrepancy is significant. The losses of a 5ppm solution of cetylpyridinium chloride over a 4 hour period are illustrated further in Figure 2.

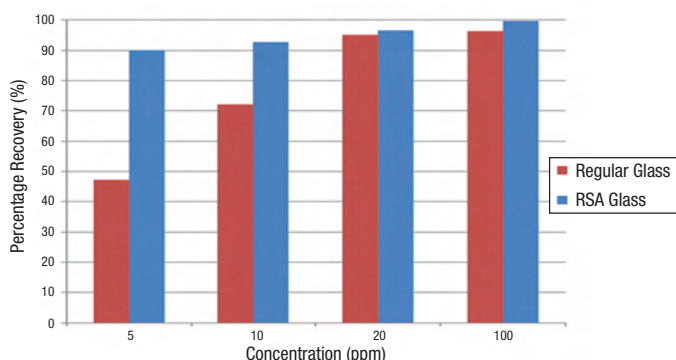

Data courtesy of MicroSolv Technologies, USA. The comparative data presented here may not be representative for all applications

Figure 1. Recovery of cetylpyridinium chloride solutions

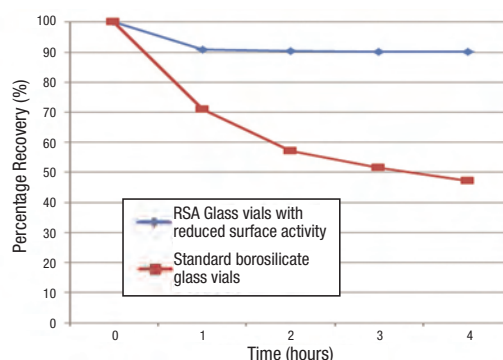

Data courtesy of MicroSolv Technologies, USA. The comparative data presented here may not be representative for all applications

Figure 2. Losses of 5ppm cetylpyridinium chloride solution

Conclusions

Compared to conventional glass vials:

- RSA Glass vials show significant reduction in adsorption of basic compounds
- RSA Glass vials give significantly greater recovery for low abundance analytes
- RSA Glass vials result in significantly greater stability of sample solution pHs

Ordering Information for RSA™ Glass Vials

RSA Glass Inserts and Vials - AQ™ (Advanced Quality) Brand (100/pack)

Description	Catalogue No.
Inserts, 29 x 6mm, 200µl, with attached plastic springs	9502S-02N-RS
Inserts, 29 x 6mm, 200µl, deactivated, with attached plastic springs	9502S-02ND-RS
2ml vials, clear 9mm screw top with write-on patch	9509S-WCV-RS
2ml vials, amber 9mm screw top with write-on patch	9509S-WAV-RS
2ml vials, clear 9mm screw top	9509S-OCV-RS
2ml vials, clear, snap/crimp top with write-on patch	9509C-WCV-RS
2ml vials, amber, snap/crimp top with write-on patch	9509C-WAV-RS
1.8ml Max Recovery vials ¹ , 8µl residual, clear, centre draining snap top	9512C-OCV-RS
1.8ml Max Recovery vials ¹ , 8µl residual, clear, centre draining 9mm screw top	9512S-OCV-RS
1.2ml, MRQ™ vials ² , 2µl residual, snap top, clear	9512C-OCV-T-RS
1.2ml, MRQ™ vials ² , 2µl residual, 9mm screw top, clear	9512S-OCV-T-RS
Vials with 300µl fused insert, snap top, clear with write-on patch	9532C-OCV-RS
Vials with 300µl fused insert, 9mm screw top, clear with write-on patch	9532S-OCV-RS
Vials with 300µl wide tip fused insert, screw top, clear with write-on patch	9532S-WCV-WT-RS
Vials with 300µl wide tip fused insert, screw top, clear with write-on patch, silanised	9532S-WCDV-WT-RS



9512C-OCV-RS



9502S-02N-RS



9512C-OCV-T-RS



9512C-OCV-T-RS

Screw Caps for RSA Glass Vials - AQ™ Brand

Description	Catalogue No.
Caps, light blue with fitted ultra pure silicone/PTFE septa, 100/pack	9509S-10C-B
Caps, light blue with fitted ultra pure silicone/PTFE septa, 1000/case	9509S-10C-B-M
Caps, light blue with preslit fitted ultra pure silicone/PTFE septa, 100/pack	9509S-30C-B
Caps, light blue with preslit fitted ultra pure silicone/PTFE septa, 1000/case	9509S-30C-B-M



9512S-OCV-T-RS



9509S-WCV-RS

Snap Caps for RSA Glass Vials - MicroSolv Brand

Description	Catalogue No.
Caps, blue with silicone/PTFE septa, 100/pack	9502C-10CB
Caps, blue with silicone/PTFE septa, 1000/case	9502C-10CB-M
Caps, blue with preslit silicone/PTFE septa, 100/pack	9502C-30CB
Caps, blue with preslit silicone/PTFE septa, 1000/case	9502C-30CB-M



9512S-OCV-RS



9532C-OCV-RS

RSA Glass Vial Easy Purchase Packs - AQ™ Brand (100/pack)

Description	Catalogue No.
2ml amber write-on vials and light blue AQR screw caps with silicone/PTFE septa	9509S-1WAP-RS
2ml clear write-on vials and light blue AQR screw caps with silicone/PTFE septa	9509S-1WCP-RS
2ml amber write-on vials and light blue AQR screw caps with preslit silicone/PTFE septa	9509S-3WAP-RS
2ml clear write-on vials and light blue AQR screw caps with preslit silicone/PTFE septa	9509S-3WCP-RS
2ml clear vials and light blue AQR screw caps with silicone/PTFE septa	9509S-1CP-RS
2ml clear vials and light blue AQR screw caps with preslit silicone/PTFE septa	9509S-3CP-RS
2ml amber write-on vials and snap caps with AQR silicone/PTFE septa	9509C-1WAP-RS
2ml clear write-on vials and snap caps with AQR silicone/PTFE septa	9509C-1WCP-RS
2ml amber write-on vials and snap caps with preslit AQR silicone/PTFE septa	9509C-3WAP-RS
2ml clear write-on vials and snap caps with preslit AQR silicone/PTFE septa	9509C-3WCP-RS
2ml amber write-on vials and snap caps with preslit red/white silicone/PTFE septa	9509C-3XWAP-RS
2ml clear write-on vials and snap caps with preslit red/white silicone/PTFE septa	9509C-3XWCP-RS
1.2ml MRQ™ vials ² , 2µl residual, clear and light blue AQR screw caps with silicone/PTFE septa	9512S-1MP-RS
1.2ml MRQ™ vials ² , 2µl residual, clear and light blue AQR screw caps with preslit silicone/PTFE septa	9512S-3MP-RS
1.2ml MRQ™ vials ² , 2µl residual, clear and blue snap caps with silicone/PTFE septa	9512C-1MP-RS
1.2ml MRQ™ vials ² , 2µl residual, clear and blue snap caps with preslit silicone/PTFE septa	9512C-3MP-RS
300µl fused insert vials and light blue AQR screw caps with silicone/PTFE septa	9532S-1CP-RS
300µl fused insert vials and light blue AQR screw caps with preslit silicone/PTFE septa	9532S-3CP-RS
1.8ml Max Recovery vials ¹ , 8µl residual, amber and light blue AQR screw caps with silicone/PTFE septa	9512S-1AP-RS
1.8ml Max Recovery vials ¹ , 8µl residual, clear and light blue AQR screw caps with silicone/PTFE septa	9512S-1CP-RS
1.8ml Max Recovery vials ¹ , 8µl residual, amber and light blue AQR screw caps with preslit silicone/PTFE septa	9512S-3AP-RS
1.8ml Max Recovery vials ¹ , 8µl residual, clear and light blue AQR screw caps with preslit silicone/PTFE septa	9512S-3CP-RS
1.8ml Max Recovery vials ¹ , 8µl residual, amber write-on with polyethylene single injection screw cap	9512S-9AP-RS
1.8ml Max Recovery vials ¹ , 8µl residual, clear write-on with polyethylene single injection screw cap	9512S-9CP-RS



9509S-WAV-RS



Easy Purchase Pack

¹ 1.8ml is the total fill volume. Vial has the external dimensions of a standard 2ml 12 x 32 vial. Recommended max fill volume 1.5ml, 8µl residual

² 1.2ml is the total fill volume. Vial has the external dimensions of a standard 2ml 12 x 32 vial. 2µl residual

Please contact Hichrom for details of additional MicroSolv vials, caps and inserts not listed above.

Macherey-Nagel offer a wide range of vials and caps compatible with most manufacturers' GC and HPLC autosamplers.

- Crimp top vials with rim diameters of 8, 11, 13 or 20mm (N 8, N 11, N 13 or N 20)
- Screw thread vials in sizes N 8, N 9, N 10, N 13, N 18 and N 24 (EPA)
- Snap top vials in size N 11
- Micro inserts for use with standard sample vials for small sample volumes
- Sample vials with integrated conical micro insert for small sample volumes
- Crimp, screw and snap top caps in different materials and with different septa type
- Headspace vials, micro reaction vials, storage vials, shell vials, crimping tools

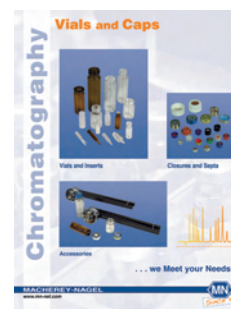

Crimp vials, caps and inserts



Screw vials, caps and inserts



Snap vials, caps and inserts

Please contact Hichrom for a copy of the Macherey-Nagel Vials and Caps brochure

A selection of some of the more popular vials is given below. Please enquire for details of vial sizes not included or for information on larger pack sizes.

Ordering Information

Description	Qty	Catalogue No.
Crimp Top Vials and Caps		
1.5ml crimp top vial N 11, clear, wide opening	100/pk	70201HP
1.5ml crimp top vial N 11, clear, wide opening, with label and scale	100/pk	702885
1.5ml crimp top vial N 11, amber, wide opening, with label and scale	100/pk	702892
Small sample volume (1.1ml) crimp neck vial N 11, clear, 15µl funnel	100/pk	702888
Small sample volume (1.1ml) crimp neck vial N 11, clear, conical	100/pk	702141
Small sample volume (1.1ml) crimp neck vial N 11, clear, conical with round pedestal glass plate	100/pk	702015
Small sample volume crimp neck vial N 11, clear, flat bottom with integrated 0.2ml insert	100/pk	702891
Small sample volume crimp neck vial N 11, amber, flat bottom with integrated 0.2ml insert	100/pk	702014
N 11 aluminium crimp cap, silver, centre hole, natural rubber/butyl red-orange/TEF colourless septum	100/pk	70256
N 11 aluminium crimp cap, silver, centre hole, silicone white/PTFE red septum	100/pk	70288
Screw Cap Vials and Caps		
1.5ml screw neck vial N 9, clear, wide opening	100/pk	702282
1.5ml screw neck vial N 9, amber, wide opening	100/pk	702293
1.5ml screw neck vial N 9, clear, with label and scale, wide opening	100/pk	702283
1.5ml screw neck vial N 9, clear, with label and scale, wide opening, silanized	100/pk	702078
1.5ml screw neck vial N 9, amber, with label and scale, wide opening	100/pk	702284
1.5ml screw neck vial N 9, amber, with label and scale, wide opening, silanized	100/pk	702079
Small sample volume (1.1ml) screw neck vial N 9, clear, 15µl funnel	100/pk	702006
Small sample volume screw neck vial N 9, clear, flat bottom with integrated 0.2ml insert	100/pk	702007
Small sample volume screw neck vial N 9, amber, flat bottom with integrated 0.2ml insert	100/pk	702008
Small sample volume polypropylene vial N 9, transparent, with 0.3ml inner cone	100/pk	702009
N 9 PP screw cap, blue, with red rubber/FEP colourless septum, centre hole	100/pk	702732
N 9 PP screw cap, blue, with silicone white/PTFE red septum, centre hole	100/pk	702287.1
Snap Cap Vials and Caps		
1.5ml snap top vial N 11, clear	100/pk	702714
1.5ml snap top vial N 11, clear, with label and scale	100/pk	702713
1.5ml snap top vial N 11, amber, with label and scale	100/pk	702712
Small sample volume snap top vial N 11, clear, flat bottom with integrated 0.2ml insert	100/pk	702709
Small sample volume polypropylene vial N 11, transparent, with 0.3ml conical insert	100/pk	702809
N 11 PE snap ring cap, blue with red rubber/TEF colourless septum	100/pk	702063
N 11 PE snap ring cap, blue, with silicone white/PTFE red septum	100/pk	702710.1
Inserts		
0.2ml Inserts for wide opening vial, clear, conical 15mm tip	100/pk	702813
0.1ml Inserts for wide opening vial, clear, with plastic spring	100/pk	702818
0.3ml Inserts for wide opening vial, clear, flat bottom	100/pk	702825

Please contact Hichrom for information on vials and caps not listed. Discounts available for bulk orders – please enquire.

TUBING

Most HPLC systems are plumbed with 1/16" o.d. tubing, which is produced in a range of materials. PEEK™ tubing has proved to be superior to stainless steel in many HPLC applications, especially where biological samples are analysed or where contact between sample and metal components must be avoided. Tubing length and i.d. should be kept to a minimum to minimise extra-column dead volume and band broadening.

Properties of different material tubing

Tubing Material	Tubing o.d.	Max. Recommended Operating Temp. (°C)	Max. Pressure for 1/16" Tubing (psi)	Chemical Resistance
Stainless steel	1/8", 1/16", 1/32"	289	n/a	May corrode with chloride salts or other buffers. May adsorb proteins. pH range 1-14.
PEEK™	1/16", 1/32", 360µm	100	7,000	Inert to almost all organic solvents. Concentrated nitric and sulphuric acids, DMSO, THF and CH ₂ Cl ₂ are not recommended. pH range 0-14.
PEEKsil™	1/16", 1/32", 360µm	100	10,000	Compatible with most organic solvents. Avoid hydrofluoric acid. pH range 0-10.
Fused silica	360µm	100	n/a	pH range 0-10.
PTFE	1/8", 1/16"	100	900	Excellent resistance to all organic solvents, acids and alkalis. pH range 0-14.

High Pressure Tubing

Tubing of 0.007" i.d. is suitable for minimal dead volume injector-column or column-detector connections of microbore (1.0 – 2.1 mm i.d.) columns or short columns containing 3µm material. For material of 2µm particle size, tubing of 0.005" can also be used. Sample and solvent must be filtered to avoid clogging and blockages of very small bore tubing.

The 0.010" tubing is suitable for connection of analytical and semi-preparative columns containing 5µm and 10µm packing material. It should be used in all parts of the system where dead volume needs to be kept to a minimum.

The 0.020" and 0.030" i.d. tubing are suitable for use in preparative systems or in non-critical connections, eg. pump to sample injector, where low flow resistance is more important than low internal volume.

Stainless Steel Tubing

- Precision bore 316 stainless steel
- Passivated for chemical resistance
- Square, burr-free ends
- Continuous coils or precut lengths

Precision bore 1/16" o.d. 316 stainless steel tubing is commonly used to connect HPLC components.

Stainless steel tubing can be supplied in continuous coils up to 25 metres in length or as precut lengths. Precut lengths have the advantage of precision finish and cut, which is especially important where low dead volume connections are required.



Ordering Information¹

Stainless steel tubing (1/16" o.d.)

Tubing i.d.		Catalogue No.
Inches	mm	
0.007	0.17	01-SS-07
0.010	0.25	01-SS-10
0.020	0.50	01-SS-20
0.030	0.75	01-SS-30
0.040	1.00	01-SS-40

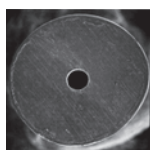

Precut tubing

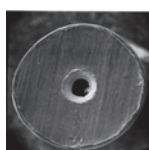

Tubing cut by a commercially available tubing cutter

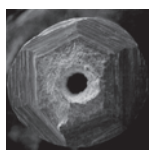

File cut tubing

Precut stainless steel tubing (1/16" o.d.)

Tubing i.d.		Length (cm)	Quantity (/pk)	Catalogue No.
Inches	mm			
0.005	0.125	5	5	05-SS-05
0.005	0.125	10	5	10-SS-05
0.005	0.125	20	5	20-SS-05
0.007	0.17	5	5	05-SS-07
0.007	0.17	10	5	10-SS-07
0.007	0.17	20	5	20-SS-07
0.010	0.25	5	5	05-SS-10
0.010	0.25	10	5	10-SS-10
0.010	0.25	20	5	20-SS-10
0.020	0.50	25	2	25-SS-20
0.020	0.50	50	1	50-SS-20

¹ Other dimensions available on request

Tubing (continued)

PEEK™ Tubing

- Biocompatible, inert and easily cut
- Good for high pressure applications

PEEK™ (polyetheretherketone) polymer tubing is biocompatible and chemically inert to most solvents. It is completely flexible, can easily be cut to desired lengths and is suitable for a wide range of applications. PEEK tubing can be used with stainless steel or polymer fittings. It has a very smooth internal surface and is the least permeable to gas of all the polymer tubing materials. $\frac{1}{16}$ " o.d. tubing (commonly 0.010" i.d.) is generally suitable for use throughout an analytical HPLC system. Alternative o.d. tubing, eg. $\frac{1}{8}$ " for high pressure semi-preparative systems and 360 μ m for capillary systems, is also available.

Ordering Information – PEEK Tubing

Tubing i.d. ($\frac{1}{16}$ " o.d.)		Catalogue No.
Inches	mm	
0.005	0.13	16-PEEK-05
0.007	0.17	16-PEEK-07
0.010	0.25	16-PEEK-10
0.020	0.50	16-PEEK-20
0.030	0.75	16-PEEK-30



PEEKsil™ Tubing

- PEEK covered fused silica
- Withstands high pressures
- Inert smooth flow path, to minimise band broadening

PEEKsil™ tubing maintains the ease of use of PEEK tubing, but offers tight i.d. tolerances. It has excellent chemical compatibility and is square-cut and polished, to make perfect connections. It is ideal for plumbing capillary and micro LC systems where conventional $\frac{1}{16}$ " or $\frac{1}{32}$ " fittings (metal or polymer) are used. It is advisable to purchase precut lengths. Please contact Hichrom for further details and ordering information.

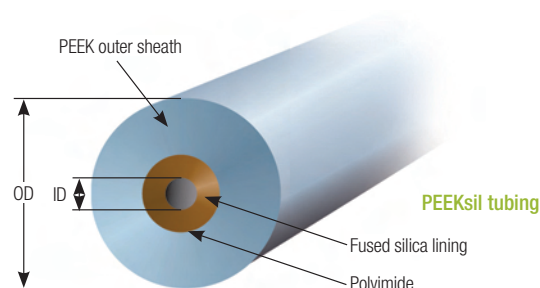

Fused Silica Tubing

Fused silica tubing is manufactured from synthetic fused silica with a polyimide coating. It is used for micro- and nano-scale HPLC and capillary electrophoresis, with the most common o.d. being 360 μ m. Please contact Hichrom for further details and ordering information.

Low Pressure PTFE Tubing

- Economical
- Flexible
- Excellent solvent resistance

PTFE (polytetrafluoroethylene) is widely used in all low pressure laboratory applications. It is the most common tubing used to connect the solvent reservoir to the pump. It is inert to all chemicals used in HPLC. PTFE is relatively porous and low molecular weight compounds can diffuse through the tubing wall.

Ordering Information – Low Pressure PTFE Tubing

Tubing i.d.		Tubing o.d. (Inches)	Catalogue No.
Inches	mm		
0.020	0.50	$\frac{1}{16}$	16-PTFE-20
0.030	0.75	$\frac{1}{16}$	16-PTFE-30
0.062	1.58	$\frac{1}{8}$	08-PTFE-62

Tubing Cutters

Stainless Steel Tubing Cutter

- Ideal for cutting $\frac{1}{16}$ " and $\frac{1}{8}$ " stainless steel tubing
- Smooth, uniform cuts



HI-192

Polymer Tubing Cutter

- Standard cutter for $\frac{1}{16}$ " and $\frac{1}{8}$ " o.d. tubing
- Compatible with PEEK and PTFE (Teflon) tubing
- Flat burr-free cuts
- Guide holes to ensure precise cutting
- Includes 5 replacement blades



HI-191

Ordering Information – Tubing Cutters

Description	Catalogue No.
Stainless steel tubing cutter	HI-192
Replacement cutter wheel for HI-192	HI-193
Standard polymer tubing cutter for $\frac{1}{16}$ " and $\frac{1}{8}$ " o.d. tubing	HI-191
Replacement blades for HI-191, 5/pk	HI-189

PEEK™ Fingertight Fittings

One-Piece Fittings

- Universal fitting, suitable for most HPLC connections
- Fingertight to 5,000psi
- Inert and biocompatible
- Excellent chemical resistance
- Void free connection
- Usable with stainless steel and PEEK tubing
- Compatible with all column end fitting types



The following one-piece PEEK™ fingertight fittings are universal fittings for use with all HPLC columns. They are convenient, easy to use and biocompatible. HI-050 is probably the most commonly used fitting in HPLC. They can be used at temperatures up to 150°C. Unlike stainless steel fittings, PEEK fingertight fittings do not permanently lock into place on the tubing, avoiding potential dead volume connection problems. They have 10-32 threads and are designed for use with all 1/16" o.d. tubing.

Description	Qty/pack	Cat. No.
PEEK fingertight fitting, natural, 10-32, for 1/16" o.d. tubing	10	HI-050X
PEEK fingertight fitting, natural, 10-32, short, for 1/16" o.d. tubing	10	HI-048
PEEK fingertight fitting, natural, 10-32, long, for 1/16" o.d. tubing	10	HI-031

Two-Piece Fittings

Two-piece fingertight fittings are designed for use with 1/16" tubing and come complete with ferrule. They are pressure rated to 6,000psi. Instead of the whole fitting, just the ferrule can be replaced, making these fingertights more economical than the one-piece versions.

Description	Qty/pack	Cat. No.
Double-winged PEEK nuts, natural, with HI-508 ferrules, 10-32	10	HI-505
Replacement PEEK ferrules, for 1/16" o.d. tubing	10	HI-508



PEEK Fingertight Column Coupler

- Universal connector
- Ultra low dead volume
- Inert and biocompatible
- Withstands pressure up to 6,000psi
- Female-female connector

PEEK one-piece fingertight column couplers are ideal for connecting two analytical columns or analytical or semi-preparative columns to guard cartridges.



Description	Cat. No.
PEEK fingertight column coupler	HI-081

Column End Plugs

- Extend column lifetime
- Fingertight design
- Fits any column

Column end plugs are used to prevent solvent evaporation from the column bed when the columns are not in use. Before storage, simply attach a column end plug to each end of the column. They are made from a chemically inert polymer and are of fingertight design.



Description	Qty/pack	Cat. No.
Column end plugs	10	HI-001

High Temperature and Pressure Fittings

For high temperature applications, polyketone (PK) fittings are recommended. Polyketone exhibits excellent biocompatibility and chemical resistance comparable to PEEK. These fittings are able to withstand pressures up to 12,000psi at room temperature or 6,000psi at 200°C.

Description	Qty/pack	Cat. No.
PK fingertight fitting 10-32 for 1/16" o.d. tubing	10	HI-035



Fittings and Connectors (continued)

SLIPFREE™ Connectors

- Void-free and leak-free connections
- Fingertight to 10,000psi
- Compatible with all commercially available end fittings
- For fast, simple multiple connections and reconnections

SLIPFREE™ HPLC connectors offer a simple, rugged way of ensuring good column connections. They are universal for all HPLC columns and consist of a precision-cut length of 1/16" (0.010" i.d.) stainless steel tubing, a Vespel ferrule and a stainless steel compression nut/locking cap assembly. Versions with 0.005" i.d. and 0.020" i.d. are also available for microbore and preparative analysis. Please enquire for details.

Single connectors are used where one connection is made frequently, such as between injector and guard or analytical column, or column to detector. Double connectors are used where both connections are made frequently, such as between analytical and guard column, or column and filter. Flexible SLIPFREE connectors are designed to bend in the middle, allowing easy connections to be made at any angle.



Description	Catalogue No.	Description	Catalogue No.
Single 6cm	HI-090	Flexible single 15cm	HI-039
Single 10cm	HI-091	Flexible single 28cm	HI-040
Single 20cm	HI-092	Flexible single 40cm	HI-041
Double 6cm	HI-095	Flexible double 15cm	HI-042
Double 10cm	HI-096	Flexible double 28cm	HI-043
Double 20cm	HI-097	Flexible double 40cm	HI-044

Viper™ Fingertight Fittings

- Zero dead volume fingertight connectors for HPLC and UHPLC
- Fingertight up to 1200 bar (17,400psi)
- Compatible with almost all valves and columns
- Suitable for temperatures up to 120°C

The Viper™ stainless steel fingertight fitting system provides zero dead volume by sealing at the tip of the tubing, without the need for ferrules. The system consists of two stainless steel fingertights combined with a flexible stainless steel capillary, which is available in different lengths from 150 to 950mm and in 0.13mm and 0.18mm i.d. Robust connections are guaranteed even under ultra-high pressures. Viper fittings are easy to use and reconnect easily between different column hardware.



Length (mm)	0.13mm i.d.	0.18mm i.d.	Length (mm)	0.13mm i.d.	0.18mm i.d.
	Cat No.	Cat. No.		Cat. No.	Cat. No.
65	6040.2307	6040.2357	550	6040.2305	6040.2355
150	6040.2315	6040.2360	650	6040.2310	6040.2395
250	6040.2325	6040.2385	750	6040.2320	6040.2370
350	6040.2335	6040.2375	850	6040.2330	6040.2380
450	6040.2345	6040.2365	950	6040.2340	6040.2390

Hichrom UHPLC Column Connectors

- Compatible with all UHPLC systems and column brands
- Avoids poor connections
- Pressure rated to >1700 bar (>25,000psi)
- Reusable

Hichrom reusable UHPLC column connectors (HI-903) have 10-32 threads suitable for use with 1/16" o.d. tubing. These fittings are reusable, as they are not permanently swaged onto the inlet tubing. An internal ferrule design prevents tubing slippage, whilst the PEEK-polymer blend front ferrule eliminates the risk of damage to receiving ports.

Description	Qty/pack	Cat. No.
UHPLC connector 10-32 thread	1	HI-903
for 1/16" o.d. tubing	10	HI-903X



HI-903

Fittings and Connectors (continued)

PEEK™ Unions

- Use to connect 2 pieces of 1/16" o.d. tubing
- Chemically inert and biocompatible
- Zero dead volume connection
- Pressure rated to 5,000psi
- Complete with two HI-505 fingertight fittings



HI-059

Description	Thru-hole	Swept Volume	Cat. No.
PEEK ZDV union, 10-32	0.010"	0.07µl	HI-059
PEEK ZDV union, 10-32	0.020"	0.28µl	HI-055

PEEK Tees and Crosses

- Use with 1/16" o.d. PEEK™ or stainless steel tubing
- Maximum operating pressure 3,500psi (241 bar)
- Includes 3 or 4 HI-505 fingertight fittings

Description	Thru-hole	Swept Volume	Cat. No.
PEEK tee, 10-32	0.020"	0.57µl	HI-032
PEEK cross, 10-32	0.020"	0.72µl	HI-034

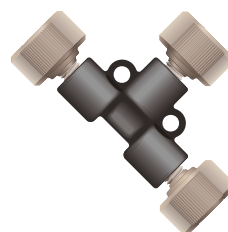

HI-032

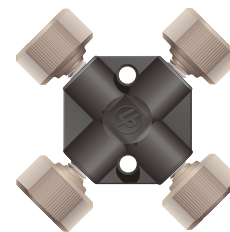

HI-034

Static Mixing Tee

- PEEK body with 2-piece fingertight fittings
- Low swept volume
- Pressure rated to 5,000psi (345 bar)

The static mixing tee HI-454 is ideal for microbore or analytical gradient HPLC. It has a low swept volume (2.2µl) and is designed for flow rates of 0.5 to 3ml/min. and a maximum pressure of 5,000psi (345 bar).

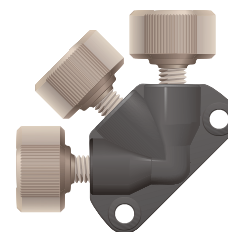

HI-454

Description	Thru-hole	Swept Volume	Cat. No.
PEEK static mixing tee for 1/16" tubing	0.020"	2.2µl	HI-454

Stainless Steel Nuts and Ferrules

Now largely replaced by PEEK fingertight fittings, except for the most searching applications, these precision machined stainless steel nuts and ferrules (threads 10-32) provide an excellent connection when needed, and are guaranteed to be both burr and contaminant free.

Description	Cat. No.
Male nut 1/16"	HI-500
Ferrule 1/16"	HI-502



HI-500



HI-502



HI-070

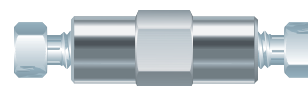

HI-752

Stainless Steel Connectors

The connector HI-070 consists of a 4cm length of 1/16" o.d. x 0.010" i.d. stainless steel tubing with appropriate 1/16" nuts and ferrules and can be used to connect female endfitting Hichrom guard and analytical columns and make similar connections. The ZDV male-male connectors (unions) have internal threads and provide zero dead volume connections. These ZDV unions are rated to 20,000psi.

Description	Cat. No.
SS 1/16" female-female connector, 0.010"	HI-070
SS ZDV union for 1/16" tubing, 0.010" thru-hole, male-male	HI-752

Fittings and Connectors (continued)

Microflow Fittings

MicroTight® PEEK™ Fittings

- For connecting capillary tubing (360µm or 1/32" o.d. or MicroTight sleeves)
- Pressure rated to 4,000psi (276 bar)
- Temperature stable up to 125°C

Description	Qty/pack	Cat. No.
Standard fitting for MicroTight tubing sleeve	10	HI-362
Standard fitting for 360µm o.d. tubing	10	HI-365
Standard fitting for 1/32" o.d. tubing	10	HI-799
Fitting plug	1	HI-804

MicroTight PEEK Connector

- Use to connect 2 pieces of capillary tubing, using tubing sleeves
- True ZDV union
- Includes fittings and gauge plug
- Pressure rated to 4,000psi

Description	Thru-hole	Swept Volume	Cat. No.
PEEK true ZDV union for MicroTight sleeves	N/A	N/A	HI-089
MicroTee for MicroTight sleeves (fittings included)	0.006"	29nl	HI-455
MicroCross for MicroTight sleeves (fittings included)	0.006"	38nl	HI-456

MicroTight PEEK Tubing Sleeves

- Colour-coded for easy i.d. identification
- Pressure rated to 4,000psi (276 bar)
- Temperature stable up to 125°C

PEEK tubing sleeves are used with MicroTight fittings to connect capillary tubing. They have an o.d. of 0.025" with a range of i.d.s suitable for use with different ports. The i.d. of the sleeve should be 0.001"- 0.002" larger than the o.d. of the capillary tubing.

Sleeve i.d. ¹	For Tubing o.d.	Colour	Qty/pk	Cat. No.
125µm	70-110µm	Red	10	HI-132
180µm	125-165µm	Yellow	10	HI-172
230µm	175-215µm	Natural	10	HI-181
395µm	340-380µm	Green	10	HI-171

¹ Other i.d. sleeves available – please enquire

NanoTight Fittings and Tubing Sleeves

- For connecting 1/16" o.d. or capillary tubing using tubing sleeves to standard 10-32 coned ports
- Pressure rated to 4,000psi (276 bar)

NanoTight fittings and sleeves are designed to connect 70µm – 1mm o.d. capillary tubing to any standard 10-32 coned port using NanoTight tubing sleeves. These fittings are made from PEEK, with the ferrule manufactured from ETFE. NanoTight tubing sleeves are manufactured from FEP fluoropolymer and have a maximum recommended operating temperature of 50°C.

Please contact Hichrom for ordering information for NanoTight fittings and sleeves.

MicroTight® 1-piece fingertight PEEK™ fittings, with 6-32 threads, are used to connect capillary tubing to MicroTight unions, adapters or filters.

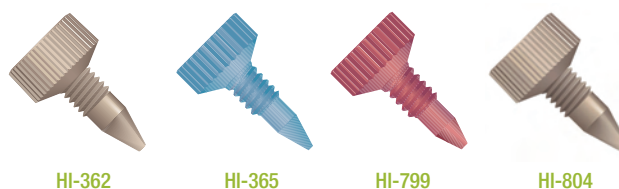

PEEK MicroTee and MicroCross

- Use to connect 1/16", 1/32" and 360µm o.d. tubing
- Low swept volume
- Use tubing sleeves to connect different o.d. tubing

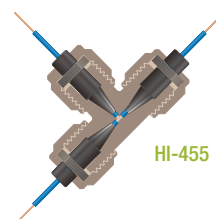

FRITS

Stainless Steel

All column frits have a carefully controlled porosity and are fabricated from 316 grade stainless steel. A 0.5µm porosity frit is recommended for 3-4µm packing materials. The use of 2µm porosity frits is recommended for retention of 5-20µm packing material. PEEK encapsulated stainless steel frits may be used to prevent sample and eluent from entering dead volume space between the end fitting and the top of the column. This results in improved peak symmetry with 1.0 – 3.2mm i.d. columns.

Bioanalytical Applications

Titanium or PAT (PEEK alloyed with Teflon) frits are preferred for the analysis of sensitive biomolecules, which may adsorb or decompose on stainless steel frits. Please enquire for further details.

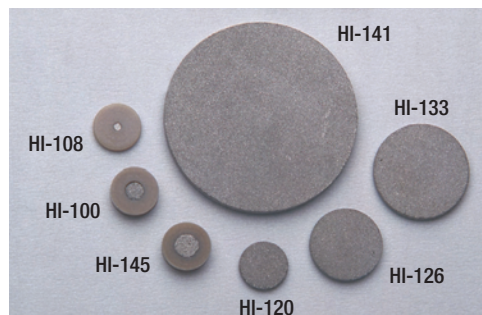

Ordering Information

Frit Material	Column i.d. (mm)	Column Diameter (inches)	Frit Thickness (inches)	Porosity (µm)	Catalogue No. ¹
Stainless steel (PEEK encapsulated)	1.0	¼	0.030	0.5	HI-127
				2.0	HI-108
Stainless steel (PEEK encapsulated)	2.1	¼	0.062	0.5	HI-103
				2.0	HI-100
Stainless steel (PEEK encapsulated)	3.2	¼	0.062	0.5	HI-104
				2.0	HI-145
Stainless steel	4.0 – 4.6	¼	0.031	0.5	HI-105
				2.0	HI-120
Stainless steel	7.75	¾	0.040	2.0	HI-126
Stainless steel	10.0	½	0.040	2.0	HI-133
Stainless steel	20.0 – 21.2	1	0.062	2.0	HI-141

¹ 10/pk

For details of frits not shown above, please contact Hichrom.

SPANNERS

The following spanners can be supplied:

Ordering Information

Description	Catalogue No.
Spanner ½" x 9/16" AF	HI-226
Spanner ¼" x 5/16" AF	HI-225
Combination spanner 3/8"	HI-940
ValvTool	HI-199

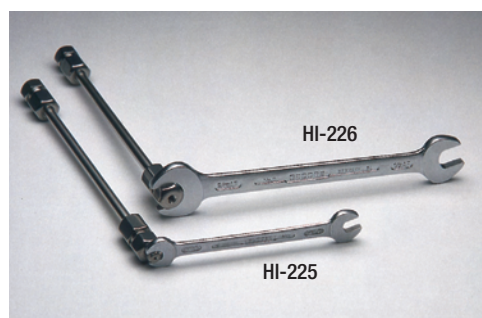

ValvTool

The ValvTool (HI-199) is a uniquely designed slotted wrench which provides easy access to many hard-to-reach areas. This enables fittings, sample loops and most other ¼" stainless steel and PEEK HPLC fittings to be more easily tightened or loosened.

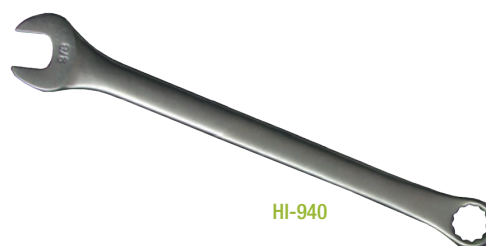

FILTERS

The use of filters is strongly recommended for complete protection of different components within an HPLC or UHPLC system. As shown in the figure below, three types of filter are used.

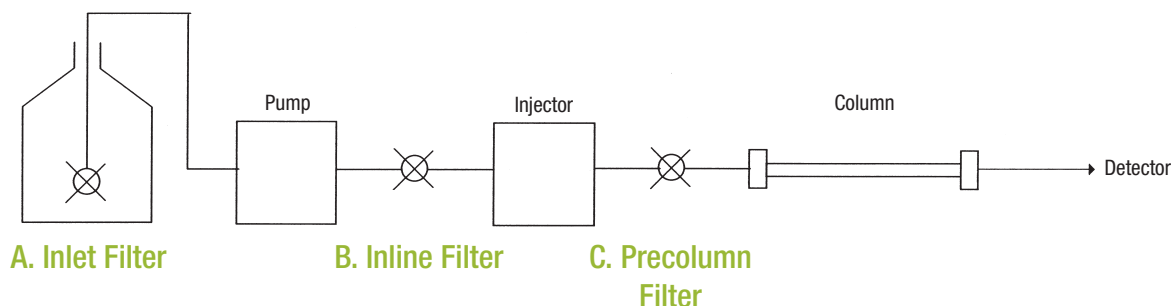

A. Inlet Filters

- Protect pump check valves
- Help remove dissolved gases

Solvent inlet filters are used at the low pressure inlet side of the pump to help protect check valves, injector and column from particulate contamination from the eluent. It is recommended that inlet filters are replaced at least every six months.

1) Stainless Steel Inlet Filter

Made from 10µm porosity stainless steel, these filters are available for connection to either 1/8" or 1/16" i.d. tubing. Their large surface area filters out particulate matter from the solvent that may otherwise damage expensive hardware. No tools are required for replacement.

Description	Catalogue No.
10µm Inlet filter with stem for 1/16" i.d. tubing	HI-583
10µm Inlet filter with stem for 1/8" i.d. tubing	HI-584



2) Bottom-of-the-Bottle™ Solvent Filters

These biocompatible filters are made from 100% PEEK, including two built-in PEEK frits. The bottom frit (2 or 10µm) will draw solvents from within 2mm of the bottom of the solvent bottle. The 2µm frit on the side may be used for a 1/8" o.d. helium sparging line.

Description	Catalogue No.
2µm PEEK filter for 1/8" o.d. tubing	HI-579
10µm PEEK filter for 1/8" o.d. tubing	HI-580



3) Last Drop™ Inlet Filter

The Last Drop™ eluent filter utilises a flat filter element which sits parallel to the bottom of the reservoir. This design enables the filter to draw all but the last 2% of the eluent from the reservoir without drawing air into the system. The Last Drop filter allows more analyses per batch of eluent and helps reduce waste compared to conventional cylindrical eluent filters. The filter contains a 316 stainless steel or PTFE filter element in an inert Teflon housing. The metal-free version should be used for sensitive biochromatography applications. A tubing connector is supplied with every Last Drop eluent filter.

Description	Catalogue No.
Last Drop Filter (2µm SS filter)	HI-692
Last Drop Filter (10µm SS filter)	HI-690
Last Drop Filter (2.5µm PTFE filter)	HI-695
Last Drop Filter (5µm PTFE filter)	HI-696
Last Drop Filter (10µm PTFE filter)	HI-694

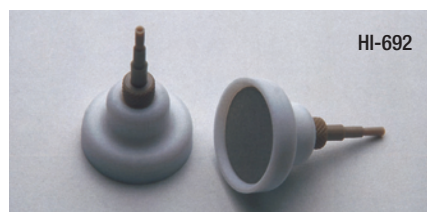

B. Inline Filters

- Protect injectors from particulates
- Compatible with all HPLC systems

Inline filters are placed between the pump and sample injection valve to trap particles released through normal piston seal wear within the pump. Hichrom offers stainless steel and biocompatible inline filters to suit various applications. It is recommended that the frits are checked frequently and replaced as soon as they contribute to a system back pressure.

1) Analytical Inline Filters

Model HI-702 comprises a stainless steel holder and a 2µm PEEK encapsulated stainless steel frit (supplied). Replacement frits (HI-100) are readily available. The HI-683 is a fingertight bioanalytical alternative, comprising a PEEK holder and a 5µm titanium PEEK-encased frit. Replacement 5µm and 2µm titanium PEEK-encased frits are available.

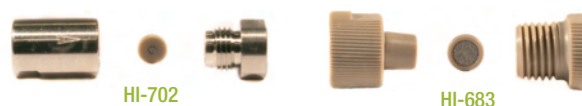

2) Preparative Inline Filter

The preparative inline filter HI-610 is suitable for use with 10-30mm i.d. HPLC and SFC columns. The filter protects the column and helps maintain performance by removing particulate matter and insoluble material from eluent and sample matrix. This versatile filter can also protect check valves, injectors and detectors.



C. Precolumn Filters

- Protect columns from particulates
- Compatible with all HPLC columns
- Ultra low dead volume

Placed immediately before the column, precolumn filters trap sample particulates. However, for samples that may irreversibly adsorb onto the column, guard cartridges are preferred, or additionally recommended.

1) ColumnSaver™ HPLC Precolumn Filter

The ColumnSaver™ fingertight precolumn filter is universally compatible with all manufacturers' endfittings. Both 2µm and 0.5µm versions are available, for the protection of columns containing packings of 5µm and 3µm respectively. The ColumnSaver precolumn filter is leakproof to over 6,000psi.

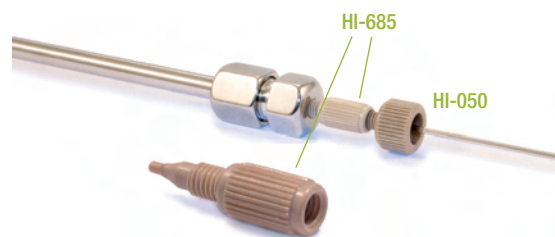

2) Hichrom UHPLC Precolumn Filter

Hichrom UHPLC Precolumn Filters are engineered specifically for use with fast, high efficiency UHPLC columns. The low dispersion of these filters ensures that the efficiency of the UHPLC column is maintained, assuring no loss of critical resolution. These filters can be installed simply on any analytical UHPLC or UPLC® column in seconds, providing leak-free filter protection to 1000 bar (15,000psi).



3) Stand-alone Precolumn Filter

Model HI-704 comprises a 'stand-alone' holder with a 2µm PEEK encapsulated stainless steel frit. Replacement 2µm and 0.5µm frits are available, providing protection for 5µm and 3µm columns respectively. The use of a fingertight coupler (HI-081, see p. 188) is recommended to connect the holder to the column inlet.

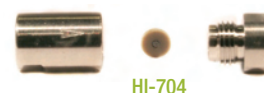

Ordering Information – Inline Filters

Description	Cat. No.
2µm Stainless steel inline filter assembly	HI-702
2µm Replacement frits for HI-702 (10/pk)	HI-100
Fingertight Ti PEEK encased inline filter (complete with 5µm frit)	HI-683
Replacement Ti PEEK encased frits (5µm) (5/pk)	HI-684
Replacement Ti PEEK encased frits (2µm) (5/pk)	HI-674
Preparative inline filter	HI-610
2µm frits for preparative inline filter (10/pk)	HI-611

Ordering Information – Precolumn Filters

Description	Cat. No.
2µm ColumnSaver (10/pk) for 5µm columns	HI-685
0.5µm ColumnSaver (10/pk) for 3µm columns	HI-686
0.5µm Precolumn filter for UHPLC columns (1/pk)	HI-602
0.5µm Precolumn filter for UHPLC columns (10/pk)	HI-602X
Precolumn filter holder with 2µm frit	HI-704
Replacement 2µm frits (10/pk)	HI-101
Replacement 0.5µm frits (10/pk)	HI-102

- Automated and manual injectors and switching valves
- Fittings and accessories

Rheodyne® valves fit virtually any flow control application. There are valves for preparative, analytical, nano and microscale analyses in a variety of flow configurations and flow rating ranges.

MX Series II™ Automated Switching Valves

- Increase laboratory productivity
- Increase reproducibility
- Flexible automation
- Increase equipment reliability

Rheodyne MX Series II™ automated fluidic valves provide productivity enhancing solutions for today's demanding analytical methods. These modular valves can be combined with current instrumentation to support complex fluid switching and sample injection needs.

Flexible Automation

The MX Series II modular valves are flexible, with several options available for connecting the valves to an analytical instrument or PC, including contact closure, BCD, serial and USB. Commands can be sent to the MX Series II valves using your chromatography software or TitanMX™ software (included) for timed-events programmability. MX Series II valves can be controlled remotely or operated manually using the push-button front panel with LED position indicator.

Reduce Downtime

The high pressure and fast chromatography MX Series II modular valves feature the Rapid Replacement Pod™ design for easy maintenance. The Rapid Replacement Pod is a complete factory assembled and tested liquid-end, providing virtually zero downtime maintenance. Traditional RheoBuild® kits (see page 344) to service your MX Series II valve are also available.

The low pressure MX Series II modular valves make changing fluidic connections quick and easy with their patented TitanEX™ fittingless tubing connection system. These long-life polymer valves meet the reliability needs of demanding applications.

Typical Applications of MX Series II Valves

1. Sample injection
2. Two column selection
3. Alternating column regeneration
4. High speed sample enrichment and clean-up
5. Sample clean-up/sample enrichment
6. Column backflushing
7. Multi-dimensional proteomic peptide separation
8. Solvent selection
9. Fraction collection
10. Six column selection

Example of MX Series II Valve Application

Figure 1 shows a schematic diagram of multi-dimensional proteomic peptide separation using a 2-position 10-port switching valve. Salt fractions eluted from the SCX column are trapped on a RP trap column. Switching the valve from Position A to Position B elutes the peptides from the trap column for further resolution on the nano RP column and detection by MS. In Position A, eluent from the SCX column traps on the RP trap column 1. While nano RP column 1 analyses the sample, RP trap column 2 traps the next salt fraction. In Position B, the SCX column is in-line with RP trap column 2, while RP trap column 1 traps the next salt fraction. Please contact Hichrom for full details of other switching applications of MX Series II valves.

Increase Laboratory Capability

The MX Series II modules are available in a variety of flow paths including options for nano, analytical and semi-preparative, as well as low pressure and fast chromatography applications and UHPLC conditions up to 15,000psi (1034 bar) - see page 196. These modules feature the reliable automation of Titan valves, saving valuable resource time and increasing overall productivity.

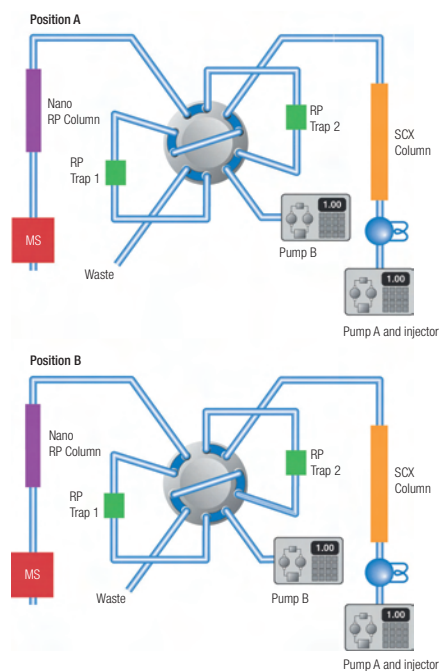

Figure 1. Multi-dimensional proteomic peptide separation using a 2-position 10-port switching valve

Ordering Information – MX Series II™ Automated Switching Valves

MXT for Fast Ultra High Pressure Chromatography Applications, up to 15,000 psi (1034 bar)

Description	Stator Passages	Typical Applications	Part Number
2-Position 6-port switching valve Stainless steel UltraLife ¹	0.011" (0.28mm)	Sample injection 2 column selection Sample clean-up/sample enrichment Column backflushing	MXT715-000
2-Position 10-port switching valve Stainless steel UltraLife ¹	0.011" (0.28mm)	2 column selection High speed sample enrichment and clean-up	MXT715-102
6-Position 7-port selector valve Stainless steel UltraLife ¹	0.011" (0.28mm)	Solvent selection Fraction collection 6 column selection	MXT715-105

MXP for High Pressure Applications, up to 6,000 psi (410 bar)

Description	Stator Passages	Typical Applications	Part Number
2-Position 6-port switching valve Stainless steel DuraLife ¹	0.012" (0.30mm)	Sample injection 2 column selection Sample clean-up/sample enrichment Column backflushing	MXP7900-000
2-Position 6-port vertical port valve Stainless steel DuraLife ¹	0.012" (0.30mm)	Sample injection	MXP7920-000
2-Position 6-port switching valve PEEK	0.012" (0.30mm)	Sample injection 2 column selection Sample clean-up/sample enrichment Column backflushing	MXP9900-000
2-Position 10-port switching valve Stainless steel DuraLife ¹	0.010" (0.25mm)	2 column selection Alternating column regeneration High speed sample enrichment and clean-up Multi-dimensional proteomic peptide separation	MXP7960-000
6-Position 7-port selection valve Titanium DuraLife II ¹	0.012" (0.30mm)	Solvent selection Fraction collection 6 column selection	MXP7970-000
2-Position 10-port switching valve PEEK	0.010" (0.25mm)	2 column selection Alternating column regeneration High speed sample enrichment and clean-up Multi-dimensional proteomic peptide separation	MXP9960-000
2-Position 6-port nano switching valve Titanium DuraLife II ¹	0.004" (0.10mm)	2 column selection Sample clean-up/sample enrichment Column backflushing	MXP7980-000
2-Position 10-port nano switching valve Titanium DuraLife II ¹	0.004" (0.10mm)	Alternating column regeneration High speed sample enrichment and clean-up Multi-dimensional proteomic peptide separation	MXP7986-000

MXX for Low Pressure Applications, up to 125 psi (9 bar)

Description	Stator Passages	Typical Applications	Part Number
2-Position 6-port switching valve RPC-7 ²	0.016" (0.41mm)	Sample injection Column selection	MXX777-601
2-Position double three-way valve RPC-7 ²	0.016" (0.41mm)	Detector selection Waste diversion	MXX777-603
6-Position 7-port selection valve RPC-7 ²	0.040" (1.0mm)	Solvent selection Fraction collection	MXX777-605
2-Position 6-port switching valve RPC-7 ²	0.060" (1.5mm)	Sample injection Column selection	MXX777-612
6-Position 7-port selection valve RPC-7 ²	0.060" (1.5mm)	Solvent selection Fraction collection	MXX777-616
10-Position 11-port selection valve RPC-7 ²	0.060" (1.5mm)	Solvent selection Fraction collection	MXX778-605

¹ Proprietary coating materials² Proprietary polymer combination

Please enquire for details of Rapid Replacement Pods™.

Manual Sample Injectors

The Rheodyne® Series-25 models are dual-mode injectors, which can be used in either a partial or complete loop filling method. In the former, a syringe determines the sample volume without wasting sample. In the complete loop filling method, the loop determines sample volume. Single-mode or fixed loop injectors use only the complete filling method.

Analytical models are for use with conventional HPLC columns with samples from 1µl to 5ml. Micro models are for 1mm and 2mm i.d. columns. Preparative models are for columns with diameters from 1cm to 10cm, operated at high flow rates, with samples from 100µl to 20ml. Models with an 'i' suffix designate the inclusion of a built-in position sensing switch to mark the injection start. Table 1 compares the characteristics of Rheodyne sample injectors, to aid selection of the most suitable model.

Table 1. Characteristics of Rheodyne® Manual Sample Injectors

Analysis Scale	Partial Filling Volumes (Range)	Sample Loop Sizes (Range)	Liquid-contact Materials	MBB ¹	Model
Dual Mode					
Analytical	1µl - 2.5ml	2µl - 5.0ml	316 SS, Vespel	Yes	7725, 7725i
	1µl - 5.0ml	2µl - 10.0ml	PEEK, Tefzel, ceramic	Yes	9725, 9725i
Micro	0.1µl - 500µl	5µl - 1.0ml	316 SS, Vespel, ceramic, PEEK	No	8125
Preparative	100µl - 10.0ml	2.0ml - 20.0ml	316 SS, PEEK	Yes	3725-038, 3725i-038
			PEEK	Yes	3725i
Single Mode					
Analytical	N/A	5µl - 5.0ml	316 SS, Vespel	No	7010 ²
		5µl - 10.0ml	PEEK, Tefzel, ceramic	No	9010

¹ MBB stands for Make-Before-Break

² MX Series II valves are recommended for new instrument installations - see pages 195-196

Dual Mode Injectors

Models 7725 and 7725i

- Make-Before-Break design
- Wide port angles for improved access to fittings
- 5µl to 5ml removable sample loops
- 2µl internal sample loop accessory

The stainless steel models 7725 and 7725i (along with the PEEK versions 9725 and 9725i) are Rheodyne's most advanced manual sample injectors for HPLC. They are based on the model 7125 which they have largely superseded. These versatile injectors can use either the partial filling or complete filling method. They can inject from 1µl to 5ml with high accuracy and precision.

The Rheodyne patented Make-Before-Break (MBB) design virtually eliminates pressure transients. Flow switching at a flat interface between a polymeric rotor seal and a ceramic stator face allows over 30,000 injections before rotor seal replacement is necessary in a clean system. Channels in the rotor seal make new connections before the old ones break. As a result flow is not interrupted when the injector is switched between LOAD and INJECT positions (see Figure 2), a benefit when using flow-sensitive detectors, fragile columns or pumps that are disturbed by flow or pressure transients.

A patented needle port design connects the tip of the syringe needle directly to the end of the sample loop, resulting in zero sample loss and no cross contamination.

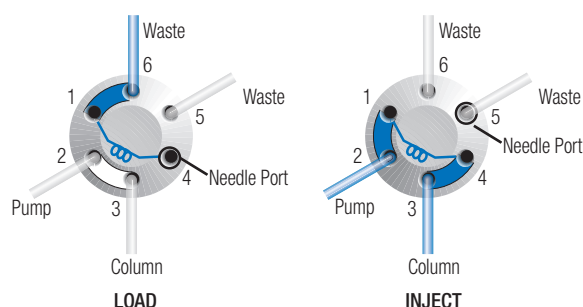

Figure 2. Flow path for typical dual mode injector

Dual Mode Injectors (continued)

Models 9725 and 9725i

- Metal-free inert flow passages
- Unaffected by buffers, acids, bases or halide salts
- For HPLC and low pressure soft gel chromatography
- Biocompatible

The Model 9725 is highly inert and well suited to the chromatography of biological molecules, including those with aggressive mobile phases. No metal components come into contact with the mobile phase. The injector is identical to Model 7725 stainless steel injector, but the loop, nuts, ferrules and stator are made of PEEK. The rotor seal polymer is Tefzel, which has an operating pH range of 0 to 14. The stator face is alumina ceramic, which is inert and resistant to wear. To avoid exposing sample to the metal syringe needle, a suction loading technique can be used.

Model 8125

- Suitable for microbore and analytical HPLC
- Accurately injects as little as 0.1 µl of sample
- Improves peak resolution
- Built-in position switch to signal injection

The Model 8125 is designed for use with 1mm and 2mm microbore columns, as well as analytical columns. It can inject sample volumes from 0.1 µl to 500 µl with zero sample waste. Small diameter flow channels produce low dispersion, maintaining the high mass sensitivity inherent in micro columns. The 8125 has a 5 µl sample loop attached, allowing partial loading of up to 2.5 µl. To facilitate low-dispersion performance, the 5 µl, 10 µl, 20 µl and 50 µl sample loops use 0.020" o.d. tubing instead of conventional 1/16" o.d. tubing.



Models 3725i and 3725-038

- For preparative HPLC columns
- Suitable for large sample volumes and high flow rates
- Stainless steel or PEEK design
- Flow rates from 10 to 800 ml/min

These injectors are as easy to use as Rheodyne's analytical scale injectors but have the capacity for larger sample volumes and flow rates. The Model 3725i has only non-metal (PEEK) parts in contact with the eluent, and is suitable for applications involving purification of biological molecules. The 3725-038 and 3725i-038 contain both PEEK and stainless steel parts. Models 3725i and 3725i-038 have a built-in position sensing switch.

Single Mode Injectors

Models 7010 and 9010

- Simplest type of injection valve
- Complete filling method of loading sample loop

Models 7010 (stainless steel) and 9010 (PEEK) are conventional single-mode 6-port injectors for the complete filling method of loading the sample loop. These are the simplest injectors, ideal for routine analysis. Loops from 5 µl to 5 ml are available. The loop can be filled by pressure or suction loading. The Models 7012 and 9012 loop filler ports are recommended for use with the 7010 and 9010 respectively. They allow the valves to be directly filled by syringe.

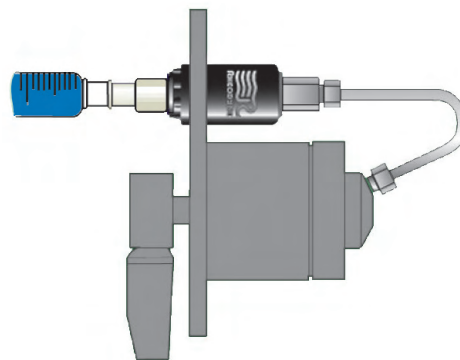

Figure 3. Suggested mounting arrangement of Model 7010 with filler port 7012

Manual Switching Valves

High pressure switching valves are used to simplify procedures and improve the speed, resolution and sensitivity of HPLC analyses. There are two major areas of application: column selection and column switching.

Column selection valves substitute one column for another without the need to manually disconnect the plumbing. This makes it easy to dedicate a separate column for each analysis. Dedicated columns eliminate equilibration delays, reduce interferences and prolong column life. The columns switched off-line are automatically sealed at both ends.

Column switching valves re-route the eluent flow during the chromatographic run. This can be done with no change in the mode of separation, such as in backflushing and fraction cutting. Alternatively, it can be multi-dimensional when the sample is sequentially separated on two or more columns, usually using different packings or eluents.

Two Position Switching Valves – Model 7000

The Model 7000 is a stainless steel six-port two-position switching valve, compatible with $\frac{1}{16}$ " fittings. Rotating the handle by 60° allows the rotor flow passages to connect different ports. The valve has many column switching uses.

Applications include:

1. Sample enrichment

Position A. Pre-column concentrates components of interest

Position B. Pre-column concentrate is flushed by second pump on to analytical column

2. Pre-column backflushing

Position A. Flow continues through pre-column and analytical column in normal direction

Position B. Only pre-column is backflushed

3. Sample clean-up

Position A. Flow through pre-column and analytical column

Position B. Pre-column flushed by second pump to remove highly retained unwanted sample components

4. Two column selection

Position A. Flow through column 1

Position B. Flow through column 2

Models accepting $\frac{1}{8}$ " fittings and large bore 'L' versions of these switching valves are available. These are used to avoid excessive pressure drops when using high flow rates. Please contact Hichrom for details.

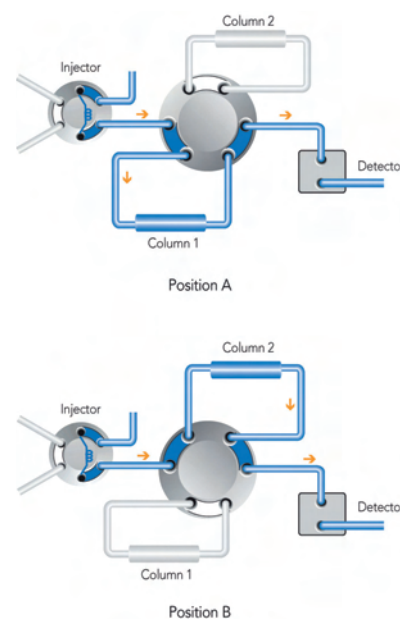

Figure 4. Two column selection using Model 7000 switching valves

Six-Position Switching Valves - Model 7060

The Model 7060 is a manually operated stainless steel selection valve, accepting $\frac{1}{16}$ " fittings. The centre port of this valve connects to the injector. Turning the valve handle directs flow into one of up to six columns connected to the six peripheral ports. A second valve is placed at the column outlets to select the operating column effluent and direct it to the detector, as shown in Figure 5. It is useful for the sixth port to be used for a bypass/flush-out tube.

Model (Catalogue No.)	Description	Stator Material
7000	2-position 6-port switching valve	Stainless steel
7030	2-position 6-port switching valve, double 3-way	Stainless steel
7040	2-position 6-port switching valve, 4-way	Stainless steel
7060	6-position 7-port switching valve, 6-way	Stainless steel

For automated switching valves, please see pages 195-196.

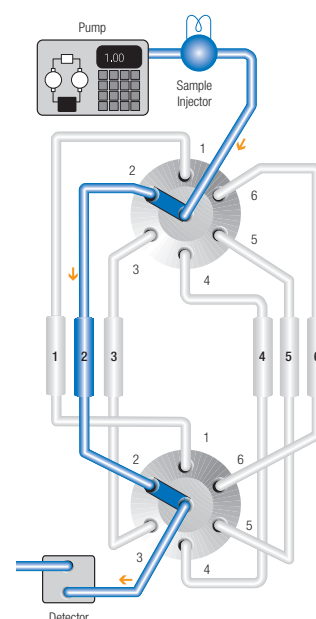

Figure 5. Six column selection using two Model 7060 switching valves

Replacement Items and Accessories

The exploded diagram (Figure 6) illustrates the components of a Rheodyne® Model 7725 sample injector. Replacement parts and accessories for all major Rheodyne injectors can be supplied.

Rotor Seals

The rotor seal is the most commonly replaced part. Vespel blend rotor seals have an operating pH range from 0 to 10. Tefzel blend and PEEK blend rotor seals have a pH range from 0 to 14.



Stators

Stators need replacement only if the ports or sealing surfaces become damaged. They are available in stainless steel and PEEK.

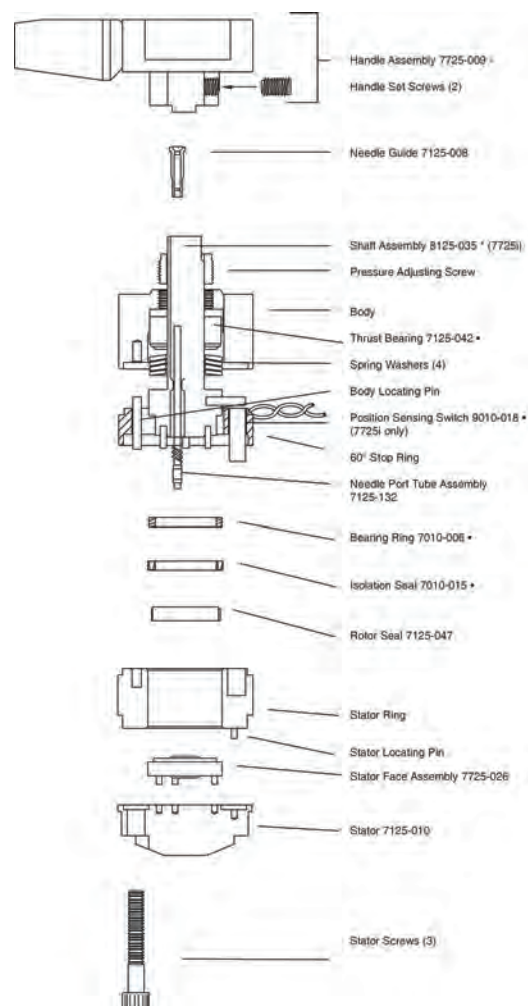

Figure 6. Replacement parts for Model 7725 valve

Sample Loops

Stainless steel and PEEK sample loops are factory-cut and finished to the highest quality. The stainless steel loop ends have a square cut. They are burr-free for a flush connection to the valve and are supplied with unswaged fittings. The flexible PEEK loop ends are provided with a clean and straight cut for low dead volume connection. A wide range of sample loops from 2µl to 20ml are available.



Further replacement items and accessories are listed on page 201.

RheFlex® PEEK Fittings

RheFlex® tube fittings provide inert, non-metal connections, and can be used with all Rheodyne injectors, valves and sample loops. The nut and ferrule are PEEK and sold as a set. The fitting holds with finger tightening on a variety of plastic and metal tubing.

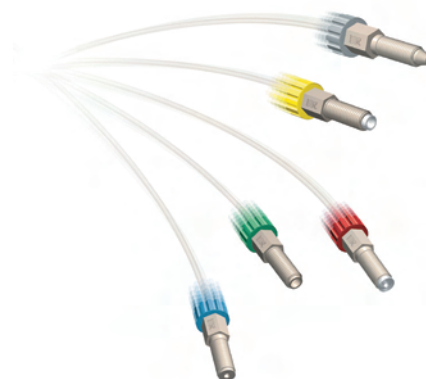

Manual Valves and Accessories

Ordering Information

Valve Series	7725	7125	8125	9725	3725	3725-038	7010	9010
Model Description				PEEK	PEEK			PEEK
Manual	7725	-	-	9725	-	3725-038	7010	9010
Injection Mark Model ¹	7725i	-	8125	9725i	3725i	3725i-038	-	-
Replacement Parts⁴								
Vespel Rotor Seal	7125-047	7125-047	8125-038	-	-	-	7010-039	-
Tefzel Rotor Seal	7125-079	7125-079	8125-097	9125-082	-	-	7010-071	9010-051
PEEK Rotor Seal	-	-	-	-	3725-018	3725-018	-	-
Stator	7725-010	7010-040	8125-098	9125-043	3725-006	3725-085	7010-040	9125-043
Stator Face Assembly	7725-026	7125-067	8125-074	7725-026	3725-039	3725-039	-	-
Nut (Bushing) + Ferrule (10/pk)	6000-209	6000-209	6000-209	6000-055 ²	-	-	6000-209	6000-055 ²
Long Nut + Ferrule (10/pk)	6000-211	6000-211	6000-211	6000-054 ²	-	-	6000-211	6000-054 ²
Extra Long Nut + Ferrule (10/pk)	6000-262	6000-262	6000-262	6000-066 ³	-	-	6000-262	6000-066 ³
Ferrule (10/pk)	6000-210	6000-210	8125-084 ³	6000-051 ²	-	-	6000-210	6000-051 ²
Isolation Seal	7010-015	7010-015	7010-015	7010-015	-	-	7010-015	7010-015
Stator Screws (10/pk)	-	-	-	-	-	-	7010-144	-
RheBuild Kit	7725-999	7125-999	8125-999	9725-999	3725-999	3725-999	7010-999	9010-999
Sample Loops				PEEK	PEEK			PEEK
2µl Sample Loop	7755-015	-	-	7755-015	-	-	-	-
5µl Sample Loop	7755-020	7020	8020	9055-020	-	-	7020	9055-020
10µl Sample Loop	7755-021	7021	8021	9055-021	-	-	7021	9055-021
20µl Sample Loop	7755-022	7022	8022	9055-022	-	-	7022	9055-022
50µl Sample Loop	7755-023	7023	8023	9055-023	-	-	7023	9055-023
100µl Sample Loop	7755-024	7024	7755-024	9055-024	-	-	7024	9055-024
200µl Sample Loop	7755-025	7025	7755-025	9055-025	-	-	7025	9055-025
500µl Sample Loop	7755-026	7026	7755-026	9055-026	-	-	7026	9055-026
1ml Sample Loop	7755-027	7027	7755-027	9055-027	-	-	7027	9055-027
2ml Sample Loop	7755-028	7028	7755-028	9055-028	3055-018	3065-018	7028	9055-028
5ml Sample Loop	7755-029	7029	7755-029	9055-029	3055-019	3065-019	7029	9055-029
10ml Sample Loop	-	-	-	9055-033	3055-023	3065-023	-	9055-033
20ml Sample Loop	-	-	-	-	3055-025	3065-025	-	-

¹ Recommended models² 5/pk³ 1/pk⁴ For both manual and injection mark models

Manual Valves and Accessories (continued)

Ordering Information (continued)

Description	Valve Series	
	7410	7520
VespeI Rotor Seal	7410-038	-
Tefzel Rotor Seal	7410-075	-
Stator	7410-041	-
0.2µl Rotor	-	7520-011
0.5µl Rotor	-	7520-012
1µl Rotor	-	7520-013
0.5µl Loop Disc	7410-070	-
1µl Loop Disc	7410-071	-
2µl Loop Disc	7410-072	-
RheBuild Kit	7410-999	7520-999

RheBuild® Kits

RheBuild® kits contain a complete selection of all the parts necessary for general valve maintenance. For front-loading injection valves, the kit includes rotor seal, stator face assembly, isolation seal, needle guide, needle port cleaner, 2 hex keys and repair instructions.



Accessory	Catalogue No.
Suction Needle Adapter	9125-076
Loop Filler Port	7012
PEEK Loop Filler Port	9012
PEEK Needle Port	9013
Needle Guide	7125-008
Needle Port Cleaner	7125-054
Mounting Panel	7160
Valve Angle Bracket	7160-010
RheFlex Standard Fittings set (5/pk)	6000-054
RheFlex Short Fittings set (5/pk)	6000-055
1/16" RheFlex PEEK ferrules (5/pk)	6000-051
ValvTool	HI-199

ValvTool

The ValvTool (HI-199) is a uniquely designed slotted wrench which provides easy access to many hard-to-reach areas. This enables fittings, sample loops and most other 1/4" stainless steel and PEEK HPLC fittings to be more easily tightened or loosened.



Needle Port Accessories

The Rheodyne adaptable loop filler ports (7012 and 9012) are used to load sample from syringe needles or luer tips. The needle port (9013) conserves sample by minimising the volume between the needle and the valve.

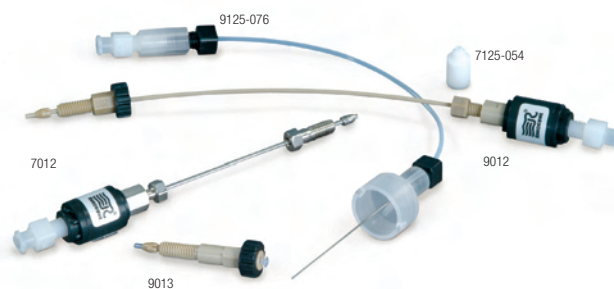

HPLC DETECTOR LAMPS

- All lamps from Quality Assured manufacturers
- All lamps tested to guarantee performance

In addition to supplying a range of Agilent UV detector and spectrophotometer lamps, Hichrom offers a range of replacement lamps for Agilent and many other commonly used HPLC UV detectors. Please enquire for instrument lamps not listed.

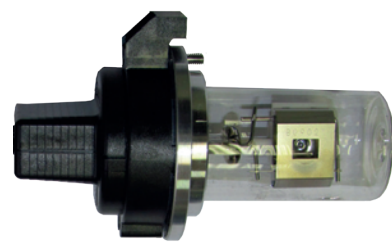

Agilent UV Detector and Spectrophotometer Lamps

Detector Type	Configuration	Lamp Type	Catalogue No.
VWD	G1314D/E/F	Long life deuterium with RFID tag	G1314-60101
	G1314A/B/C, 1120, 1220 Infinity LC	Long life deuterium	G1314-60100
DAD/MWD	G1315C/D, G1365C/D	Long life deuterium with RFID tag	2140-0820
	G1315A/B, G1365A/B	Long life deuterium	2140-0813
	G1315A/B, G1365A/B	Long life deuterium	5182-1530
	G1315A/B/C/D, G1365A/B/C/D	Tungsten	G1103-60001

Replacement Lamps for Other Detectors and Spectrophotometers

Instrument Manufacturer ¹	Model ²	Catalogue No.
Agilent	G1315A/B, G1365A/B, G1314A/B/C	LAG-1001
		LAG-1002
Applied Biosystems	757, 759, 783A, 785A, 980 + others	LAP-1001
Cecil Instruments	1000, 1070, 2000, 5000 and 6000 Series + others	LCE-1001
Gilson	115, 116, 117, 118, 119, 151, 152, 153, 155	LGI-1001
		LKA-1001
Knauer	8700, 9700 Welchrom Series	LKA-1002
		LPE-1001
Perkin Elmer	Int. 2000, Int. 4000, LC55, LC55B, LC65T, LC75, LC85, LC135 Lambda Series	LPE-1007
		LSH-1001
Shimadzu	LC3, LC4A, LC6A UV- Series	LSH-1004
		LVA-1002
Varian	Spectra A10, Spectra A20, Spectra A30, Spectra A40, 75 Series	LWA-1001
Waters	480, 481, 480LC, 481LC, Lambda Max 484	LWA-1001
		LWA-1002

¹ Lamps for other manufacturers' models also supplied

² Lamps for other models also supplied

SYRINGES

HPLC valve injection syringes utilise needles (point style 3) characterised by a 90° square tip whose edges are chamfered and polished to eliminate damage to the rotor seal and stator face of the injector valve. This style of needle tip is also suitable for pipetting liquids. Please contact Hichrom for details of other syringes available (including syringes for GC).

Hamilton Syringes

Hamilton MICROLITER® 700 series syringes are the standard syringe used in many laboratories throughout the world. For optimum reproducibility, it is recommended that the barrel should always be filled to its maximum capacity, but the volume injected should not exceed 80% of the syringe volume.

Hamilton GASTIGHT® 1700 series syringes use teflon as the inert plunger seal. With these syringes, liquids only come into contact with glass and teflon. They are recommended for bioanalytical applications.

Glass barrels and syringe plungers of the same capacity are interchangeable for the 1700 series syringes, but not for the 700 series syringes.

Luer Tip Syringes

To remove contamination from valve sample loops, flushing with a larger volume Luer tip syringe is recommended.

Please contact us for ordering information details for syringes.

SGE Syringes

SGE manufacture an extensive range of HPLC syringes for use with Rheodyne or Valco syringe-loading injection valves. Syringes with either a fixed needle or a removable needle and repeating adaptor are available.

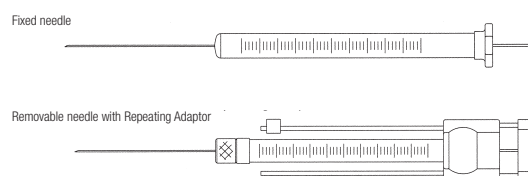

Ordering Information

Luer tip syringe	Syringe Code	Cat. No.
2 ml	-	HI-252
5 ml	-	HI-255

SMART CAPS

Smart Healthy Caps (for inlet solvent bottles)

- Protect health
- Minimise solvent evaporation
- Maintain accurate solvent concentrations
- No external contamination of eluent

Smart Healthy Caps were designed to comply with the increasing safety regulations of the modern laboratory. They are made from inert, chemically resistant materials, such as PTFE and polypropylene. Figure 1 shows a Smart Healthy Cap screwed onto a solvent inlet reservoir.

The use of Smart Healthy Caps can reduce harmful solvent evaporation from solvent inlet reservoirs by up to 80%, protecting health and keeping the HPLC eluent concentration accurate for several days. This is achieved by the use of a one-way check valve (Figure 2), which allows air to enter the bottle for pressure equalization, but eliminates solvent vapour emissions.

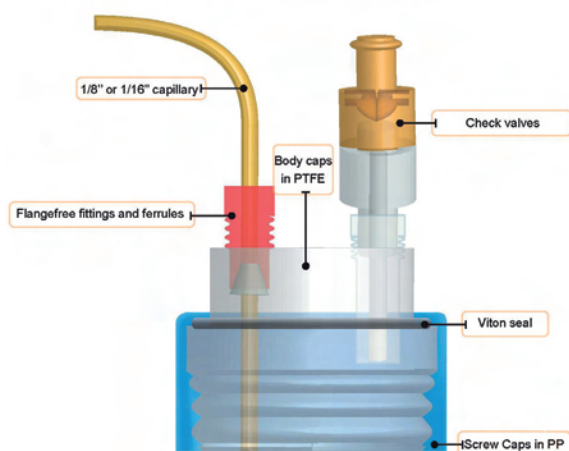

Figure 1. Smart Healthy Cap on solvent inlet reservoir

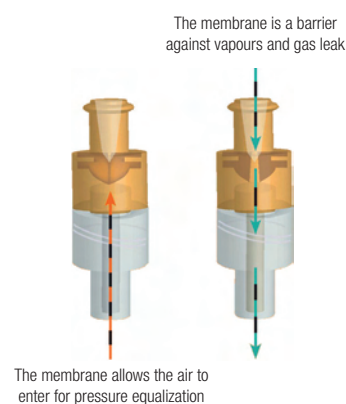

Figure 2. One-way check valve

Smart Healthy Caps also protect solvents against external contamination and are available to fit a wide range of bottle types and sizes. They can be supplied with 1 to 4 outlet ports to accommodate multiple HPLCs. Tubing ($1/8''$ or $1/16''$ o.d.) is securely fixed by use of a ferrule and flange-free fitting. Smart Healthy Caps are designed to fit the standard GL45 bottle thread. For alternative bottle threads such as GL40 and GL32, adaptors are available (see Figure 3).

Ordering Information

Smart Healthy Caps¹ (to fit standard GL45 bottle thread)

No. Outlet Ports	Catalogue No.
1	SHC-1
2	SHC-2
3	SHC-3
4	SHC-4

¹ Supplied with check valve, fittings and ferrules for $1/8''$ o.d. tubing (fittings and ferrules for $1/16''$ o.d. tubing supplied on request)

Smart Healthy Caps Adaptors (to convert a GL40 or GL32 thread for use with GL45 Smart Healthy Caps)

Adapter Thread	Material	Cat. No.
GL40	Teflon	AD-40-T
GL40	Polypropylene	AD-40-PP
GL32	Teflon	AD-32-T
GL32	Polypropylene	AD-32-PP



Figure 3. Smart Healthy Caps adaptors

Starter Kit – contains:

- 1 x Smart Healthy Cap GL45 thread with 2 x $1/8''$ outlet ports
- 2 x Fittings and ferrules for $1/8''$ tubing
- 1 x Port plug for unused ports
- 1 x check valve

Cat. No. SHC-2-SK

(Contains everything required)

Please contact Hichrom for Smart Healthy Cap items not listed above.

Smart Waste Caps (for waste solvent bottles)

- Protect health
- 95% reduction in harmful emissions
- Activated charcoal filter cartridge

Smart Waste Caps reduce harmful substance emissions from waste bottles by up to 95% and are available to fit a wide range of waste bottle sizes, including drums. They allow waste solvents from an HPLC to enter the waste bottle but prevent solvent vapours from escaping into the laboratory, by use of an activated charcoal filter cartridge. Smart Waste Caps (see Figure 4) are available to fit waste solvent containers with GL45 to S90 threads (and can be custom manufactured for all applications).

Smart Waste Caps can be supplied with multiple inlet ports to accommodate multiple HPLC lines. Tubing (1/8" or 1/16" o.d.) is securely fixed by use of a ferrule and flange-free fitting. Larger o.d. tubing (up to 9mm) can be connected by use of a barbed connector.

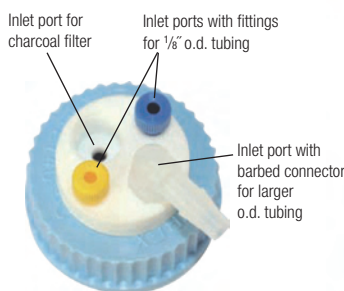

SW45-2-C-1L
Smart Waste Cap

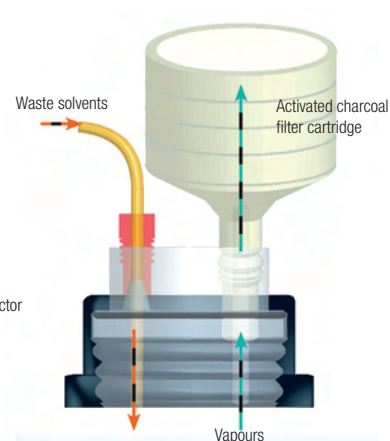

Figure 4. Smart Waste Cap on solvent waste bottle

Ordering Information

Smart Waste Caps (charcoal filter cartridge purchased separately – see below)

No. and Type of Inlet Ports	Thread Size			
	GL45	S51/S55	S60/S61	S90
3 x 1/8" (or 1/16") inlet ports ¹	SW45-3-C	SW55-3-C	SW60-3-C	SW90-3-C
4 x 1/8" (or 1/16") inlet ports ¹	SW45-4-C	-	-	-
1 x 1/8" (or 1/16") + 3 barbed inlet ports ¹	-	SW55-1-C-3L	-	-
2 x 1/8" (or 1/16") + 1 barbed inlet port ¹	SW45-2-C-1L	SW55-2-C-1L	SW60-2-C-1L	-
3 x 1/8" (or 1/16") + 1 barbed inlet port ¹	SW45-3-C-1L	-	-	SW90-3-C-1L
3 x 1/8" (or 1/16") + 2 barbed inlet ports ¹	-	-	-	SW90-3-C-2L
3 x 1/8" (or 1/16") + 3 barbed inlet ports ¹	-	-	SW60-3-C-3L	-
4 x 1/8" (or 1/16") + 1 barbed inlet port ¹	-	-	SW60-4-C-1L	SW90-4-C-1L

¹ Comes with fittings and ferrules for 1/8" o.d. tubing and 90° angled barbed connectors for 6-9mm o.d. tubing as standard. Fittings and ferrules for 1/16" o.d. tubing and 90° angled and straight barbed connectors for 3-4mm, 5-6mm and 9-11mm o.d. tubing, plus straight barbed connectors for 6-9mm o.d. tubing are available on request.

Charcoal Filter Cartridges

Wt. Charcoal (g)	Lifetime (months)	Cat. No.
25	3	FC25
50	6	FC50
100	12	FC100



Figure 5. Charcoal filter cartridges



Please contact Hichrom to request your Smart Caps catalogue

Barbed Connectors

Tubing o.d. (mm)	90° Angled	Straight
3 - 4	RC-34	RD-34
5 - 6	RC-56	RD-56
7 - 9	RC-69	RD-69
9 - 11	RC-911	RD-911

Starter Kit – contains:

- 1 x Smart Waste Cap GL45 thread with 3 x 1/8" inlet ports
- 3 x Fittings and ferrules for 1/8" tubing
- 2 x Port plugs for unused ports
- 1 x 25g Charcoal filter cartridge

Cat. No. SW45-3-C-SK
(Contains everything you need)

Many chemical, pharmaceutical, environmental and other products are quality controlled and tested by HPLC methods. A reliable and robust HPLC method is therefore a vital and integral component of the production and quality process. DryLab®4 is a tool which helps the chromatographer to produce better more reliable HPLC and UHPLC methods in a shorter time. It helps you to structure and organise your work, so enabling you to save time and consumables used during method development and make the final results more predictable, reliable, transferable and successful.

DryLab®4 – Key Points

- Latest version of the acclaimed DryLab chromatography modelling software, which has evolved over 25 years.
- Allows you to develop better, more robust HPLC/UHPLC methods faster and more efficiently.
- Also allows you to optimise or modify existing HPLC methods for successful transfer to alternative UHPLC/HPLC equipment.
- Features improved “peak tracking” to speed up data entry and improve correct peak identification on imported chromatograms.
- Improved functionality allows for 1, 2 and 3 chromatographic parameters (e.g. % organic, temp, pH etc.) to be modelled simultaneously.
- Allows modelling results to be easily visualised as a “2D colour resolution map” or “3D colour resolution cube”.
- From just 12 runs you can model 1,000,000 possible solutions.
- New robustness module allows you to simply and quickly explore the boundaries of robustness, cumulatively or independently, for all specified parameters.
- Fully compatible with the principles of Quality by Design (QbD).

A Truly Powerful Tool for HPLC Method Development

The screenshot displays the DryLab 4 software interface. On the left, there are panels for 'Additional Instrument Parameters', 'General Column Parameters', 'Status', and 'Peak Properties'. The main area features a 'Resolution Map' (2D heatmap) and a 'Resolution Cube' (3D visualization). Below these is a 'Chromatogram' showing peaks over time. On the right, there are three smaller chromatograms for different runs. At the bottom right, a table lists peak data for four runs.

	Run: 1	Run: 2	Run: 3	Run: 4						
1	0.43	Phthalic acid	6.36	4403	7.24	440	4.12	438	4.71	439
2	1.54	Vanillic acid	6.21	568	9.17	578	4.89	581	6.21	583
3	13.73	Benzoic acid	6.42	122	5.76	111	5.11	128	6.85	93
4	5.22	Aspirinic acid	7.51	894	10.88	819	5.55	792	6.59	796
5	3.80	Vanillin	7.43	431	11.32	391	5.82	396	7.88	406
6	58.43	Synthaldehyde	7.66	909	12.21	287	6.22	323	9.10	300
7	9.46	Phthalic acid	9.35	851	12.87	678	6.22	714	9.34	689
8	28.78	Cisro-vanillin	8.91	279	15.88	878	7.90	889	10.88	878
9	38.08	Benzoic acid	10.71	89	13.87	294	6.73	335	9.36	304
10	17.87	Trans-2-Admethoxy	11.99	109	21.76	110	9.91	123	18.99	182
11	6.73	Methyl benzoate	13.65	152	23.28	170	11.09	168	20.56	184
12	57.78	Ethyl benzoate	0.00	0	28.00	166	12.76	163	25.52	171

Contact Hichrom for a demonstration copy of DryLab 4

Product Description

DryLab software consists of a core module and two other optional modules. Depending on the modules purchased, DryLab 4 will provide the functions described below. It is available in single or multi-licence format.

- 1) **The Core Module** allows 1D & 2D modelling and is required for all applications in DryLab 4.
- 2) **The 3D Design Space Module** is required to enable 3D modelling and for the results to be visualised as a 3D cube.
- 3) **The Robustness Module** gives you a statistical evaluation of just how robust your method is and highlights which parameters are more important than others. This includes an evaluation of those parameters that are not being directly modelled such as ‘flow rate’ for example.

To discuss individual requirements and to obtain pricing information please contact Hichrom Limited.

Chromatography Modelling and Simulation Software (continued)

DryLab[®] 4

Why should you invest in DryLab[®] 4?

DryLab[®] helps you find the best solutions for your sample separation challenges. For twenty-five years, scientists from major international pharmaceutical and chemical companies, as well as universities and other organisations, have utilised DryLab to create high quality HPLC methods to meet the needs of their demanding applications. Anybody working in the realm of HPLC who wishes to economise on the resources spent developing and running methods will benefit from the advantages offered by DryLab. The most important reasons for adopting DryLab technology into your HPLC laboratory are considered to be as follows:

- **To save time and cost**

Method development and optimisation with DryLab is a streamlined and efficient process. Methods developed in DryLab often have run times that are 50% shorter compared to methods developed by traditional 'trial and error' approaches. This can mean significant increases in productivity for both equipment and staff. A DryLab model uses real data to accurately simulate literally thousands of experiments, meaning experimental work normally requiring valuable time in the laboratory can be done instantly. How many times has a whole day or week of HPLC method development effort left you no further ahead than you were at the beginning? DryLab can prevent this from happening by providing you with information which allows you to decide which experiments are worth pursuing and which are dead-ends not worthy of your time.

The pharmaceutical industry spends up to 16% of the R&D cost of a new drug on the development and execution of HPLC methods. A non-robust method will be overly sensitive to the fluctuations in parameters typical when a method is deployed across a multitude of instruments, locations, and users. The time spent compensating and adjusting for the problems arising from a non-robust method will cost time and money and may result in production delays or even whole batches of drug substance being lost.

DryLab's method development motto is to make it right the first time. High quality robust HPLC methods can be developed faster than ever before, and the Design Space built into the DryLab model provides a comprehensive knowledge that gives you long-term security and confidence in any future method amendments and validations. In many cases, optimisation of a methanol/acetonitrile/buffer ternary solvent blend in the mobile phase achieves a degree of selectivity not possible with just acetonitrile alone.

Shorter run times mean that more samples can be analysed per column and the use of expensive solvents and mobile phase additives minimised. The use of cheaper alternative solvents such as methanol can be considered from the beginning, often with no sacrifice in method benchmarks like resolution and robustness. Waste disposal costs will therefore fall.

- **To help update and transfer methods**

DryLab's Gradient Editor predicts the optimum linear gradient for your separation and lets you model multi-segmented gradients or adjust methods for different instrument configurations. It is straightforward to transfer a method to an instrument with a different dwell volume. In addition, you can use DryLab to facilitate updating methods from traditional long columns (250 x 4.6mm, 5µm) onto shorter UHPLC columns with smaller particle sizes.

- **To help conform to FDA 'Quality by Design' standards**

The new Quality by Design (QbD) concept of the FDA requests the scientific elaboration of the Design Space for the proposed HPLC method. With its comprehensive resolution and robust mapping abilities, Drylab is perfectly geared to this task. Peak movements can be modelled making it easy to determine the tolerance thresholds that define method robustness. You will be able to comfortably assure the FDA regulators about the high quality of your methods using a DryLab model to illustrate the science based reasoning for your choice of working conditions.

- **To help teach and train new chromatographers**

Training new staff requires a big investment in time and resources, and mistakes made at the instrument can be costly. DryLab lets novices do their initial learning on a computer. As they alter experimental conditions, DryLab updates the chromatogram instantaneously, helping old and new chromatographers alike to quickly gain an insight into a method's properties. Such immediate feedback makes it a powerful tool to teach the fundamental principles of chromatographic retention mechanisms.

DryLab comes complete with a detailed Tutorial Guide and many useful examples for practical instruction to help all users get a successful start to DryLab HPLC method development.

The more you use DryLab, the more time and money you save – and the more confidence you have in the methods you develop!



BOOKS

Introduction to Modern Liquid Chromatography

3rd Edition

L.R. Snyder, J.J. Kirkland and J.W. Dolan

The third edition of this popular book features new HPLC applications and technologies, including chiral compound separations and bioseparations. An update of HPLC computer software and technology is also included, making this book a complete compendium of HPLC methods and applications.

978-0470167540

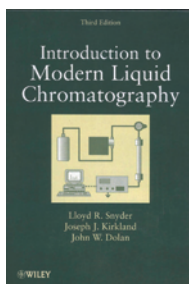
**Practical HPLC Method Development**

2nd Edition

L.R. Snyder, J.J. Kirkland and J.L. Glajch (Wiley)

This essential reference describes the practical application of chromatographic theory to method development. Organised examples show the analyst how to control the many separation variables in a simplified and easy-to-follow format. Sample preparation, separation optimisation, detection and quantitation are discussed in detail, along with more specialised applications such as chiral and preparative separations.

978-0471007036

**UHPLC in Life Sciences**

Ed. D. Guillarme and J. Veuthey

This new book discusses the basics of UHPLC and its application in the field of drug analysis. A general overview of instrumentation and columns is given. Method transfer between HPLC and UHPLC, coupling of UHPLC and MS and a comparison of the performance of totally porous and superficially porous particles are discussed.

978-1849733885

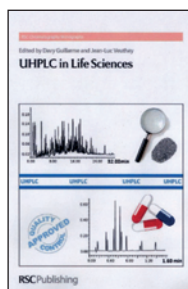
**A Practical Handbook of Preparative HPLC**

Donald Wellings (Elsevier)

This book concentrates on practical, hands-on advice for preparative HPLC from laboratory to process scale. It will help ensure optimal design, equipment and separation results for those in the pharmaceutical, agrochemical and biotechnology industries.

978-1856174664

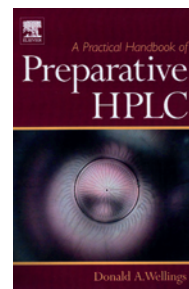
**Handbook of Chemistry and Physics**

W. M. Haynes (CRC Press)

This 93rd edition of the CRC Handbook of Chemistry and Physics is an indispensable sourcebook for chemists. It features many new or completely revised tables, providing the most comprehensive and up-to-date data, as well as advances in the chemical and physical sciences.

978-1439880494

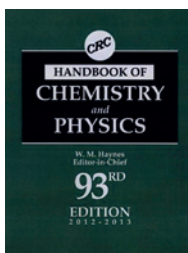
**The HPLC Solvent Guide**

2nd Edition

P. Sadek (Wiley)

This revised and expanded edition is a valuable working reference offering experimentalists an overview of the solvent's role in HPLC. It provides detailed coverage of all commonly used HPLC solvents.

978-0471411383



BOOKS (continued)

High Performance Gradient Elution: The Practical Application of the Linear-Solvent-Strength Model

Lloyd R. Snyder and John W. Dolan (Wiley)

Written by two well-known authorities in HPLC, this book takes the mystery out of the practice of gradient elution, by giving a comprehensive description of the theory, methodology and applications across many fields of HPLC. The focus is on the use of linear-solvent-strength theory in predicting gradient LC behaviour.

978-0471706465

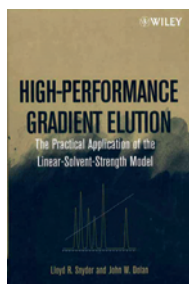
**Troubleshooting LC Systems: A Comprehensive Approach to Troubleshooting LC Equipment and Separations**

John W. Dolan and Lloyd R. Snyder (Humana)

This invaluable book is based on the authors' immensely successful short courses and their wide experience of hands-on troubleshooting LC problems. After a discussion of fundamental principles of LC, various preventative maintenance routines are offered along with a thorough treatment of all aspects of troubleshooting.

978-0896031517

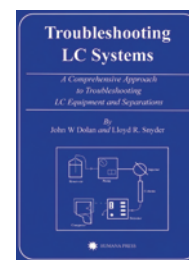
**Pitfalls and Errors of HPLC in Pictures**

3rd Edition

Veronika R. Meyer (Wiley)

This book contains over 100 examples of common pitfalls and sources of error in HPLC analysis. All examples are presented with a concise, instructive text and an informative figure, as well as equipment tests or quality assurance strategies.

978-3527332939

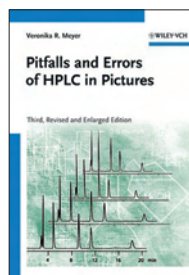
**Modern HPLC for Practicing Scientists**

Michael W. Dong (Wiley)

This is a concise text, which presents the most important fundamentals, applications and developments of HPLC. It describes basic theory and terminology for the novice, and reviews relevant concepts, best practices and modern trends for the experienced practitioner.

978-0471727897

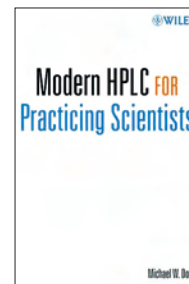
**HPLC Methods for Pharmaceutical Analysis**

Ed. G. Lunn and N. Schmuft (Wiley)

This useful reference tool provides a readily accessible source of abstracts of the most up-to-date literature on HPLC methods developed for the most commonly prescribed pharmaceutical compounds. Each drug covered includes a number of detailed procedures, enabling analysts to replicate the technique without reference to the original. Extensively annotated bibliographies are included.

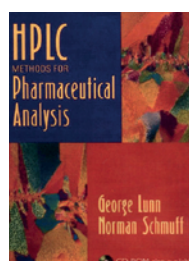

Vol. 1	978-0471181767
Vol. 2	978-0471331896
Vol. 3	978-0471331902
Vol. 4	978-0471331919
Vol. 1-4	978-0471332978
Vol. 1-4 CD-ROM	978-0471332565

Handbook of Derivatization Reactions for HPLC

Ed. G. Lunn and L.C. Hellwig (Wiley)

This book/CD-ROM offers a convenient and easily searchable data base of derivatives for HPLC and capillary electrophoresis (CE). It contains fully abstracted procedures from more than 1,900 papers. The CD-ROM is fully searchable by derivatization type, reagent, compound, reaction matrix, procedure and literature reference. The data is organised by functional group and then by individual reagents.

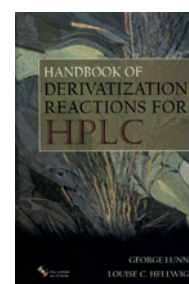

Book	978-0471238881
CD-ROM	978-0471238898
Book and CD-ROM	978-0471164586

BOOKS (continued)

High Performance Liquid Chromatography. Fundamental Principles and Practice

Ed. W.J. Lough and I.W. Wainer (CRC Press)

This book provides an introduction to the use and applications of HPLC in routine chemical analysis. It follows a logical progression from basic principles to instrumentation and applications. The book is written for advanced undergraduates in analytical chemistry, pharmaceutical analysis, applied biochemistry, biotechnology and pharmacology.

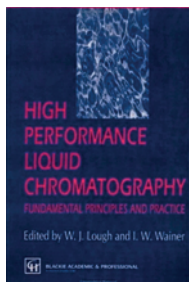

978-0751400762

ACOL. High Performance Liquid Chromatography

Sandie Lindsay (Wiley)

This ACOL (Analytical Chemistry by Open Learning) text provides the beginner with a working knowledge of the basic principles and theory behind HPLC techniques. The book covers the foundations of liquid chromatography, instrumentation, column packings and many important applications.

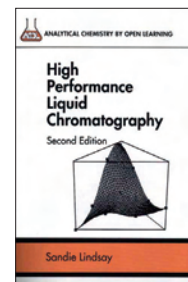

978-0471931157

Liquid Chromatography-Mass Spectrometry

R.E. Ardrey (Wiley)

This indispensable reference source is the first book to concentrate on principles of LC-MS. It also describes instrumental aspects of LC-MS and discusses the current applications and practical benefits of the technique.

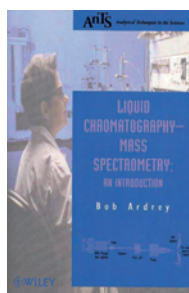
978-0471498018
(Paperback)**Practical Problem Solving in HPLC**

S. Kromidas (Wiley)

This guide addresses 45 common questions of HPLC users. It explains simple equipment tests and selection criteria for columns and buffers. As well as dealing with specific problems and how to solve them, it features addresses of manufacturers, references, data tables and check lists.

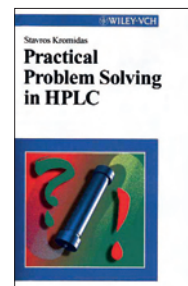

978-3527298426

Solid Phase Extraction: Principles and Practice

E.M. Thurman and M.S. Mills (Wiley)

This book presents a clear explanation of basic SPE theory, mechanisms of interaction, method development and troubleshooting. Detailed coverage of SPE applications in clinical, environmental and natural product chemistry is provided. In addition, this book features practical examples illustrating a range of real-world SPE uses.

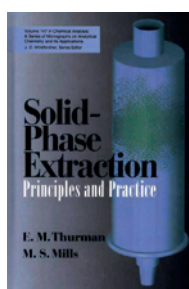

978-0471614227

Modern Practice of Gas Chromatography

4th Edition

Ed. R.L. Grob and E.F. Barry (Wiley)

Widely regarded as the classic on gas chromatography, this guide offers everything needed to run, maintain, and interpret the results from GC. The fourth edition has been updated with information on some of the newer techniques in GC.

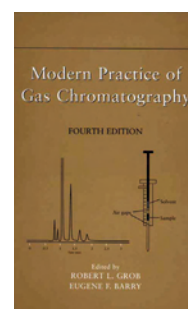

978-0471229834

Activity. In adsorption chromatography, the relative strength of the surface of the packing. For silica gel, the more exposed the silanol groups, the more active the surface. Activity can be controlled by adding water or another polar modifier, which is hydrogen-bonded to the active sites, thereby reducing the surface activity.

Additive. A substance added to the mobile phase to improve the separation or detection characteristics.

Adsorption. The process of retention in which the interactions between the solute and the surface of an adsorbent dominate.

Affinity Chromatography. A technique in which, for the macromolecule of interest, a biospecific adsorbent is prepared by coupling a specific ligand (such as an enzyme, antigen or hormone) to a solid support (or carrier). This immobilised ligand will interact only with molecules that can selectively bind to it. Molecules that will not bind elute unretained. The retained compound can later be released in a purified state. Affinity chromatography is seen as an on-off technique.

Asymmetry (As). Asymmetry (skew) is a factor describing the shape of a chromatographic peak. Theoretically it is assumed peaks are symmetrical and of Gaussian shape. Practically, the peak asymmetry factor is measured as shown on p.10. A value of >1 indicates a tailing peak and <1 a fronting peak.

Back Pressure. The difference in pressure between the inlet and outlet of a column.

Bar. A unit of pressure equal to one atmosphere. It is equivalent to 14.5 pounds per square inch (psi) or 0.1 Megapascal.

BET Method. A method developed by Bruner, Emmett and Teller for measuring surface area. The level of liquid nitrogen adsorption within the pores of the phase is measured at very low temperatures. Pore volume and pore size distribution methods can also be obtained by this method.

Biocompatible. A term used to indicate that a tubing or fitting material will not change the biological activity of material coming into contact with it during the HPLC analysis time. It frequently means metal-free components.

Bonded. Term which implies that the stationary phase is chemically bonded to the surface of the supporting material.

Bonded Phase Coverage. Refers to the amount of bonded phase on a silica support. Coverage is usually described in mmol/m² or in terms of percentage carbon.

Capacity Factor (k'). An old term for a chromatographic parameter that measures the degree of retention (t_R). Now defined as the retention factor (k) by the IUPAC.

Channelling. Occurs when voids created in the packing material of a column may cause eluent and accompanying solutes to move more rapidly than the average flow velocity, resulting in band broadening. The voids are created by poor packing or by erosion of the packed bed.

Check Valve. A device built into an HPLC pump which allows the flow of eluent in one direction only.

Chiral Stationary Phase (CSP). Stationary phase designed to separate enantiomeric mixtures.

Column Dead-time (t_0). The time taken for solvent molecules or other non-retained peaks to move through the column.

Column Efficiency (N). A term used to express the width of a peak produced by a column. Efficiency is measured in terms of the number of plates, a parameter which is inversely related to the square of the peak width. See p.10 for the full calculation.

Counterion. In an ion-exchange process, the ion in solution used to displace the ion of interest from the ionic site. In ion-pairing, it is the ion of opposite charge added to the eluent to form a neutral ion pair in solution.

Dead Volume. A measure of solvent accessible volume between the injector and detector after the space occupied by the column packing material has been subtracted. Both interstitial column volumes and system (injector, detector, connecting tubing and end fittings) volumes contribute. The dead volume can be determined by injecting an inert compound (i.e. a compound that does not interact with the column packing) and measuring its retention volume.

Degassing. The practice of removing dissolved gases from the eluent. It can be achieved by helium sparging, applying vacuum to the eluent, ultrasonification or heating.

Denaturing. The process of destroying the tertiary and quaternary structure of a protein.

Desalting. A technique in which low molecular weight salts and other compounds are removed from non-ionic and high molecular weight compounds. An example is the use of size exclusion columns to exclude large molecules and retain lower molecular weight salts.

Dwell Volume. The volume between the point of mixing of solvents (usually in the mixing chamber or at the proportioning valves of the HPLC instrument) and the head of an LC column. Particularly important in gradient elution.

Elutropic Series. A series of solvents with an increasing degree of polarity, generally used to explain solvent strength.

Elution Volume. Refers to the volume of eluent necessary to elute a solute from a column. For a symmetrical peak, it is the volume from the point of injection to the volume at maximum concentration.

GLOSSARY (continued)

Endcapping. The reaction of a silylating reagent with unreacted accessible silanols remaining on the silica surface after the initial bonding reaction. The process may reduce undesirable adsorption of basic or polar molecules which otherwise may cause peak tailing.

Exclusion Limit. In SEC, the upper limit of molecular weight (or size) beyond which molecules will elute at the same retention volume (exclusion volume). Many SEC packings are referred to by their exclusion limit. For example, a 10^5 column of porous silica gel will exclude any compounds with a molecular weight higher than 100,000 based on a polystyrene calibration standard.

Flash Chromatography. A very fast form of classic LC used by synthetic organic chemists for rapid purification. Performed primarily in the normal-phase mode, sometimes with reversed-phase chromatography.

Fractionation Range. In SEC, refers to the range in which the packing can separate molecules based on their size. Molecules that are too large to diffuse into the pores are excluded. Molecules that can diffuse into all of the pores totally permeate the packing, eluting unseparated at the permeation volume.

Fronting. A term describing a peak shape whose front has a leading edge.

Gel Filtration Chromatography (GFC). SEC carried out with aqueous eluents. It is sometimes referred to as aqueous GPC. Most gel filtration separations involve biopolymers.

Gel Permeation Chromatography (GPC). SEC carried out with organic eluents. Used for the separation and characterisation of polymers.

Gradient Elution. The process by which the strength and composition of the eluent is increased during the chromatographic run, thereby reducing analysis time. Binary, ternary and quaternary solvent gradients are routinely used.

Guard Column. A short column placed between sample injector and the inlet of the main column. It protects the analytical column against contamination from sample particulates and strongly retained solutes. The guard column is usually of cartridge format requiring a holder and packed with the same material as in the main column.

Helium Sparging. The process of bubbling helium through the eluent to remove dissolved gas.

High Pressure Mixing. A procedure in which two or more solvents are mixed on the high pressure side of the pumping system to form a final eluent. One pump is required per solvent.

Hybrid Silica. Silica gel comprising both organic and inorganic moieties with hybrid properties of polymeric packings and silica packings. Offers different selectivity but better high pH stability than bare or uncoated silica gel.

Hydrophilic. A description of compounds, solvents or bonded phases that either readily dissolve in water or prefer water to non-polar organic solvents, ie. 'water-loving'.

Hydrophilic Interaction Chromatography (HILIC). The use of polar stationary phases and partially aqueous eluents to separate compounds in order of increasing hydrophilicity (polarity).

Hydrophobic. A term describing compounds, solvents or bonded phases that dissolve easily in non-polar organic solvents such as hexane or prefer such solvents to water, ie. 'water-hating'.

Hydrophobic Interaction Chromatography (HIC). A protein separation technique in which reversed-phase materials are used with eluents containing high salt concentrations. Gradients are run by decreasing salt concentrations with time.

Hyphenated Techniques. Refers to the family of techniques best known by their acronyms, including LC-mass spectrometry (LC-MS), LC-Fourier transform IR spectroscopy (FTIR) and LC-MS/MS.

Injection Solvent. The solvent the sample is dissolved in prior to chromatographic analysis.

Interstitial Volume. The volume between the particles. It does not include the volume in the pores of the particles.

Ion Chromatography. An ion-exchange technique in which low concentrations of organic and inorganic anions or cations are determined using ion-exchangers of low ion-exchange capacity with dilute buffers.

Ion-Exchange Capacity. A measure of the number of ionic sites that can take part in the exchange process. Exchange capacity is expressed in mequiv/g.

Ion Exclusion. The process in which ionised solutes can be separated from non-ionised or partially ionised solutes using ion-exchange resins. Ionised solutes will move faster down the column.

Ion-Pair Chromatography. A form of reversed-phase chromatography in which ions in solution can be paired or neutralised prior to separation as an ion-pair. Ion-pairing reagents are usually ionic compounds that contain a hydrocarbon chain. The latter imparts a certain hydrophobicity to the resultant ion-pair allowing it to be retained on a reversed-phase column.

Ion Suppression. Buffering in an aqueous eluent at a particular pH to suppress solute ionisation. Useful for improving peak shape of weak acids and bases in reversed-phase chromatography.

GLOSSARY (continued)

Irreversible Adsorption. When a compound with a very strong affinity for an adsorbent is injected onto a column, it can be adsorbed so strongly that it cannot be eluted from the column.

Isocratic. Chromatographic conditions in which a constant composition eluent is used.

Isoelectric Point. The pH point at which a molecule no longer has a net charge.

Ligand-exchange Chromatography. A technique in which chelating ligands are added to the eluent. On adsorption onto the stationary phase they act as chelating agents. An example is the use of copper amine chelates for the separation of amino acids.

Loadability. The maximum amount of analyte that can be injected onto a column that no longer permits the isolation of product at the desired level of purity or recovery level. Important in preparative chromatography.

Low Pressure Mixing. A pumping procedure in which two or more solvents are mixed on the low pressure side of the pump. Only one pump is required.

Mass Transfer. The process of solute movement between the moving and stationary zones. The faster the mass transfer process, the better the column efficiency. Mass transfer is represented by the C-term in the van Deemter equation.

Mean Pore Diameter. A term that refers to the average diameter of the pores within a phase.

Megapascal (MPa). A unit of pressure. One MPa equals about 10 bar (atmospheres) or 145 pounds per square inch (psi).

Modifier. A chemical added to reversed-phase solvent systems designed to optimise the chromatographic separation.

Monomeric Phase. A bonded phase in which individual molecules are bonded to a support. For silica, monomeric phases are typically prepared by the reaction of an alkyl- or aryl-monochlorosilane or alkoxy silane.

Nano LC. LC carried out with columns less than 100µm in internal diameter. Usually requires specialised instrumentation.

Overload. A saturation of the stationary phase by the solute which is evidenced by band broadening, tailing and flat edged chromatographic peaks.

Particle Size (dp). This term refers to the average particle size of the material packed into a column.

Particle Size Distribution. A measure of the distribution of the particles used to manufacture a column. In HPLC a narrow particle size distribution is desirable. For a 10µm size particle, a particle size distribution of $dp \pm 10\%$ means that 90% of the particles have a 9-11µm size.

Peak Broadening. The tendency of a chromatographic peak to broaden as it passes through the column. It is also known as peak spreading or peak dispersion. The peak width or the number of theoretical plates in the column (N) is a measure of peak broadening.

Peak Capacity. The number of equally well-resolved peaks that can fit in a chromatogram between the hold-up volume and some upper limit in retention.

Polarity. A measure of the separation of charges within a molecule. Polar molecules interact more strongly with and are best separated on polar stationary phases.

Polymeric Packing. Packings based on polymeric materials, usually in the form of spherical beads. Common polymers include polystyrene-divinylbenzene, polymethylmethacrylate and polyvinylalcohol.

Polymeric Phase. A bonded phase in which typically a di- or trichlorosilane is reacted with more than one reactive silanol group on the surface of silica.

Pore Size (Mean Pore Diameter). The average diameter of the pore in a porous packing. The pore diameter is important in that it must allow free diffusion of solute molecules into and out of the pore so that the solute can interact with the stationary phase. In SEC, the packings have different pore diameters, and therefore molecules of different sizes can be separated. For a typical adsorbent such as silica gel, 60Å and 100Å pore diameters are most popular. For packings used for the separation of biomolecules, pore diameters >300Å are used.

Pore Volume. The total volume of the pores in a porous packing, usually expressed in ml/g. It is measured by the BET method of nitrogen adsorption or by mercury intrusion porosimetry, where Hg is pumped into the pores under high pressure.

Precolumn. A column packed with silica placed between the pump and the injector. It presaturates the eluent with stationary phase minimising loss of the latter from the main column. It will also remove particulate material.

Pressure Drop. The difference in pressure between the inlet and outlet of a column during flow caused by the hydrodynamic resistance of the packed bed.

Process Scale Chromatography. Refers to the use of LC at the industrial scale level. Generally requires specially designed columns (eg. internal diameters > 5cm), recoverable solvents, low cost packings and overloaded operating conditions compared with laboratory scale HPLC.

Residual Silanols. These are the silanol (-SiOH) groups that remain on the surface of a silica after a bulky phase is chemically bonded to its surface. Their numbers can be reduced by further reacting (endcapping) the silica surface with a small organosilane.

GLOSSARY (continued)

Resolution (R_s). A measure of the separation of two adjacent peaks. The higher the resolution value the greater the separation (see p.216).

Retention Factor (k). The period of time that the sample component resides in the stationary phase relative to the time it resides in the mobile phase (see p.216).

Retention Time. The elapsed time between sample injection and the appearance of the chromatographic peak apex.

Sample Capacity. The term refers to the amount of sample that can be injected onto a column without overloading it. In preparative applications it is typically expressed as grams of solute per gram of stationary phase.

Scalability. In going from analytical to preparative chromatography, refers to the reproducibility of results on columns of different internal diameters and/or particle sizes when using the same bonded phase. A linear scale-up process minimises time required to optimise preparative separations.

Separation Factor (α). A thermodynamic factor that is a measure of relative retention of two substances. Formerly called 'selectivity' or 'selectivity factor'.

Siloxane Bond. The main -Si-O-Si- bond found in silica.

Size Exclusion Chromatography (SEC). A mode of HPLC used mainly to separate high molecular weight samples and to determine their molecular weight distribution by virtue of their size in solution. Also known as gel permeation, gel filtration or steric exclusion chromatography.

Superficially Porous Particle. A particle of typical diameter 2 to 5 μ m, with a solid core and a porous outer shell.

Surface Area. The total area of the phase's solid surface, as determined by an accepted measurement technique such as the BET method, which uses nitrogen adsorption. For silica it is typically 100-600 m²/g.

Surface Coverage. Usually refers to the mass of stationary phase per unit area bonded to a chromatographic support. Often expressed in micromoles per square metre of surface. Sometimes the percentage of carbon is given as an indicator of surface coverage.

Tailing. The phenomenon in which a peak has an asymmetry factor >1. The downside of the peak will be skew.

Theoretical Plate. Measure of column efficiency. Length of column relating to this concept is called height equivalent to a theoretical plate (HETP).

Trace Enrichment. Technique in which trace amounts of compounds are retained on an HPLC or precolumn packing out of a weak eluent or solution and then are eluted by adding a stronger eluent, in a concentrated form.

Van Deemter Equation. Equation used to explain band broadening in chromatography. The equation represents the height of a theoretical plate (HETP) and has three terms. The A-term describes eddy dispersion or diffusion. The B-term represents the contribution of molecular or longitudinal diffusion of the solute passing through the column. The C-term is the contribution from interphase mass transfer of solute between stationary phase and eluent.

Void. The formation of a space, usually at the head of the column, caused by a settling or dissolution of the packing. A void in the column leads to decreased efficiency and loss of resolution.

Void Volume (V_0). The total volume of eluent in the column, the remainder being taken up by packing material. Can be determined by injecting an unretained substance.

Zero Dead Volume (ZDV). It refers to a fitting or component which adds no extra volume to the system. In practice ZDV fittings have a finite but insignificant volume.

Zwitterions. Compounds that carry both positive and negative charges in solution.

A	Absorbance	IMAC	Immobilised metal-ion affinity chromatography
AA	Amino acid	IPA	Isopropanol (propan-2-ol)
ACN	Acetonitrile	IPC	Ion pair chromatography
ADP	Adenosine 5'-diphosphate	ISRP	Internal surface reversed-phase
AGP	α_1 -acid glycoprotein	IUPAC	International Union of Pure and Applied Chemistry
amu	Atomic mass unit	LC-MS	Liquid chromatography-mass spectrometry
APS	Aminopropylsilyl	LDR	Linear dynamic range
ATP	Adenosine 5'-triphosphate	LDV	Low dead volume
AU	Absorbance units	LEC	Ligand exchange chromatography
AUFS	Absorbance units full scale	LIF	Laser-induced fluorescence
BDS	Base deactivated silica	LLE	Liquid/liquid extraction
BSA	Bovine serum albumin	MALDI	Matrix assisted laser desorption ionisation
CBH	Cellobiohydrolase	MECC	Micellar electrokinetic capillary chromatography
CCC	Countercurrent chromatography	MEKC	Micellar electrokinetic chromatography
CE	Capillary electrophoresis	MEPS	Microextraction in packed syringe
CEC	Capillary electrochromatography	MMSE	Monolithic material sorptive extraction
CFC	Chlorofluorocarbon	MS	Mass spectrometer
CI	Chemical ionisation	MSD	Mass-selective detection
CPS	Cyanopropylsilyl	MOS	Monooctylsilane
CSP	Chiral stationary phase	NIR	Near infrared
CT	Charge transfer	NP	Normal-phase
CZE	Capillary zone electrophoresis	NPR	Non-porous resin
DAC	Dynamic axial compression	ODS	Octadecylsilane
DACC	Donor-acceptor complex column	OPA	o-Phthalaldehyde
DAD	Diode array detection	PAD	Pulsed amperometric detection
Dabsyl	4-Dimethylaminoazobenzene-4-sulphonyl chloride	PAGE	Polyacrylamide gel electrophoresis
Dansyl	5-Dimethylaminonaphthalene-1-sulphonyl chloride	PAH	Polycyclic aromatic hydrocarbon
DCM	Dichloromethane	PAT	PEEK alloyed with Teflon
DEAE	Diethylaminoethyl	PCR	Polymerase chain reaction
DEG	Diethylene glycol	PCR	Post column reaction
DHPLC	Denaturing HPLC	PEEK	Polyetheretherketone
DMSO	Dimethyl sulphoxide	PEG	Polyethylene glycol
DNA	Deoxyribonucleic acid	PEI	Polyethyleneimine
DNPH	2,4-Dinitrophenylhydrazine	PEO	Polyethylene oxide
DRI	Differential refractive index	PID	Photoionisation detection
EC	Electrochemical	PK	Polyketone
ECD	Electrochemical detection	PLOT	Porous-layer open-tubular
EDTA	Ethylenediaminetetraacetic acid	PMMA	Polymethylmethacrylate
EI	Electron impact (or electron ionisation)	PRP	Polymeric reversed-phase
ELISA	Enzyme-linked immunosorbent assay	PS-DVB	Polystyrene-divinylbenzene
ELSD	Evaporative light-scattering detector	PTC	Phenylthiocarbonyl
EOF	Electroosmotic flow	PTFE	Polytetrafluoroethylene
ESI	Electrospray ionisation	PTH	Phenylthiohydantoin
FAB	Fast atom bombardment	PVA	Polyvinylalcohol
FAME	Fatty acid methyl ester	PVDF	Polyvinylidene difluoride
FFAP	Free fatty acid phase	RAM	Restricted access media
FIA	Flow-injection analysis	RI	Refractive index
FID	Flame ionisation detection	RP	Reversed-phase
FLEC	1-(9-Fluorenyl)ethyl chloroformate	SAX	Strong anion-exchanger
FMOC	9-Fluorenylmethoxycarbonyl chloride	SCOT	Support-coated open-tubular
FPD	Flame photometric detection	SCX	Strong cation-exchanger
FPLC	Fast protein liquid chromatography	SDS	Sodium decyl (or dodecyl) sulphate
FTIR	Fourier transform infrared	SEC	Size (or steric) exclusion chromatography
GC-MS	Gas chromatography-mass spectrometry	SFC	Supercritical fluid chromatography
GFC	Gel filtration chromatography	SFE	Supercritical fluid extraction
GLC	Gas-liquid chromatography	SIM	Selected (single) ion monitoring
GPC	Gel permeation chromatography	SLE	Solid-supported liquid-liquid extraction
HAC	Hydroxyapatite chromatography	SMB	Simulated moving bed
Hb	Haemoglobin	SPE	Solid phase extraction
HEMA	Hydroxyethylmethacrylate	SPME	Solid phase microextraction
HETP	Height equivalent to a theoretical plate	SPP	Superficially porous particle
HFBA	Heptafluorobutyric acid	SPS	Semi-permeable surface
HFIP	Hexafluoroisopropanol	SRM	Standard reference material
HIC	Hydrophobic interaction chromatography	TEAA	Tetraethylammonium acetate
HILIC	Hydrophilic interaction chromatography	TFA	Trifluoroacetic acid
HPIC	High performance (pressure) ion chromatography	THF	Tetrahydrofuran
HPLC	High performance liquid chromatography	TLC	Thin layer chromatography
HPTLC	High performance thin layer chromatography	TMS	Trimethylsilyl
HRGC	High resolution gas chromatography	UHPLC	Ultra high performance liquid chromatography
HSA	Human serum albumin	USP	United States Pharmacopoeia
IAM	Immobilised artificial membrane	WAX	Weak anion-exchanger
IC	Ion chromatography	WCX	Weak cation-exchanger
ICP	Inductively coupled plasma	WCOT	Wall-coated open-tubular
ICR	Ion cyclotron resonance	ZDV	Zero dead volume
IEC	Ion-exchange chromatography		

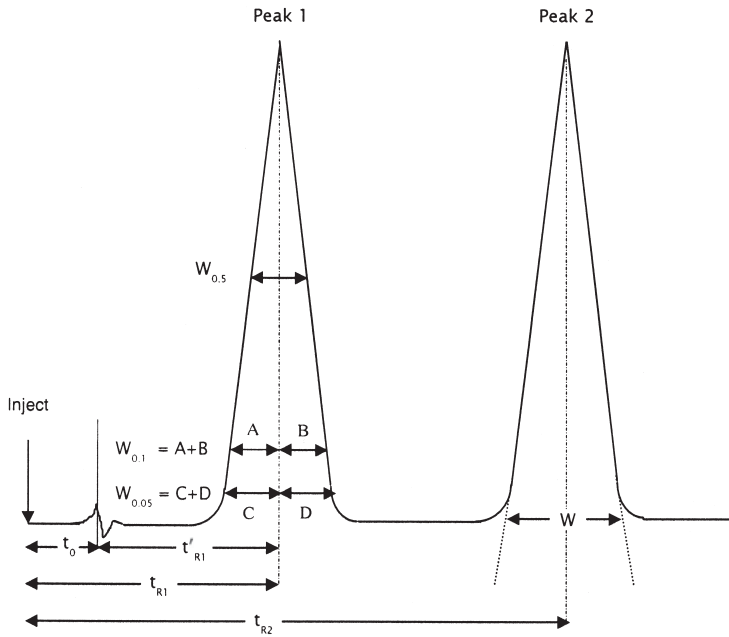

where:

- t_0 = Retention time of unretained peak
- t_{R1} = Retention time of component 1
- t_{R2} = Retention time of component 2
- $w_{0.5}$ = Peak width at 50% peak height
- $w_{0.1}$ = Peak width at 10% peak height
- $w_{0.05}$ = Peak width at 5% peak height
- w = Peak width at base
- A = Peak front distance at 10% of peak height
- B = Peak tail distance at 10% of peak height
- C = Peak front distance at 5% of peak height
- D = Peak tail distance at 5% of peak height

The following equations are based on the terms defined above.

Adjusted (net) Retention Time (t'_R) $t'_{R1} = t_{R1} - t_0$

Selectivity

Retention Factor (k) $k = \frac{t_R - t_0}{t_0} = \frac{t'_R}{t_0}$

Separation Factor (α) $\alpha = \frac{k_2}{k_1}$

Performance

Column Efficiency (N)
(plate number or number of theoretical plates) $N_{0.5} = 5.54 \left(\frac{t_R}{w_{0.5}}\right)^2$ or $N_{0.1} = 18.55 \left(\frac{t_R}{w_{0.1}}\right)^2$

Height Equivalent to a Theoretical Plate (HETP) $H = \frac{L}{N}$ where L = length of column

Reduced Plate Height (h) $h = \frac{H}{dp}$ where dp = average particle diameter

Peak Shape

Asymmetry Factors (see p.10) $AS_1 = \frac{N_{0.1}}{N_{0.5}}$ $AS_2 = \frac{B}{A}$

USP Tailing Factor $T = \frac{w_{0.05}}{2C}$

Resolution $R_s = 2 \left(\frac{t_{R2} - t_{R1}}{w_1 + w_2}\right)$

or

$R_s = \frac{\sqrt{N}}{4} \left(\frac{\alpha - 1}{\alpha}\right) \left(\frac{k}{k + 1}\right)$ where k is the average retention factor for peaks 1 and 2

Miscibility

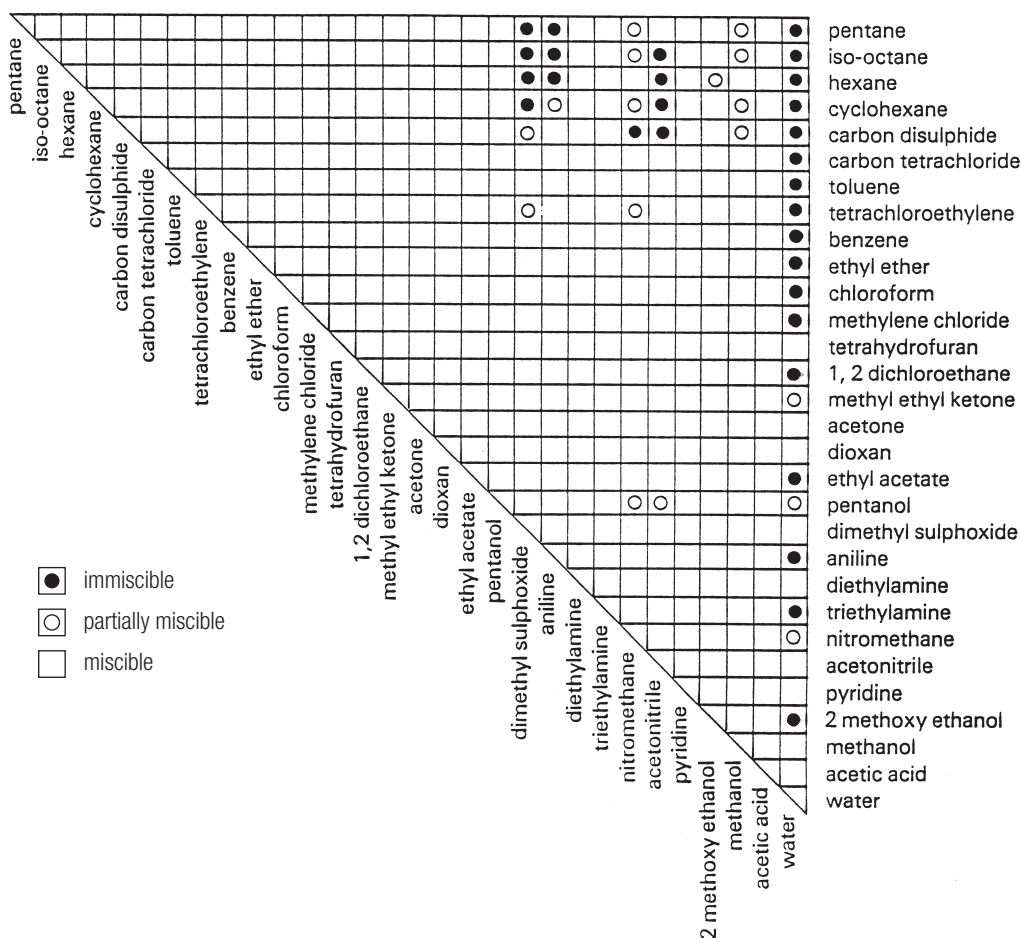

Viscosity, Refractive Index and UV cut-off

Solvent	Viscosity (cPoise)	Refractive Index	UV cut-off (nm)
pentane	0.23	1.358	210
iso-octane	0.50	1.404	210
hexane	0.33	1.375	200
cyclohexane	1.0	1.427	210
carbon disulphide	0.37	1.626	380
carbon tetrachloride	0.97	1.466	265
toluene	0.59	1.496	285
tetrachloroethylene	0.90	1.505	240
benzene	0.65	1.501	280
diethylether	0.23	1.353	220
chloroform	0.57	1.443	235
dichloromethane	0.44	1.424	235
tetrahydrofuran	0.55	1.445	215
1, 2 dichloroethane	0.79	1.445	225
methyl ethyl ketone	0.40	1.381	330
acetone	0.32	1.359	330
dioxan	1.54	1.422	220
ethyl acetate	0.45	1.370	260
1 pentanol	4.1	1.410	210
dimethyl sulphoxide	2.24	1.478	280
aniline	4.4	1.586	350
diethylamine	0.38	1.387	275
triethylamine	0.38	1.401	280
nitromethane	0.67	1.394	380
acetonitrile	0.37	1.344	190
pyridine	0.94	1.510	305
2 methoxy ethanol	1.72	1.401	220
methanol	0.60	1.329	205
acetic acid	1.26	1.372	—
water	1.0	1.330	—

The routine use of in-line filters and/or guard cartridges (see pages 193-194 and 20-21) is strongly recommended by Hichrom for protection of HPLC columns from both frit blockage and irreversible sample adsorption. However, even with the use of guard cartridges, over a period of time columns may become contaminated by strongly adsorbed sample components. This may be indicated by a steadily increasing back pressure generated by the column, a sudden increase in the back pressure, loss of column efficiency, increased tailing and shouldering or even peak splitting.

The protection of UHPLC columns is also recommended and guard cartridges should be used where available. Guard cartridges capable of withstanding the high pressures required are not available for all manufacturers' UHPLC columns. In these cases, it is advisable to use a precolumn filter which can operate at high pressures (see page 194).

In order to maximise column lifetime, particularly with UHPLC columns, the following tips should be considered:

- Use only ultra-pure UHPLC/HPLC grade solvents
- Use freshly prepared aqueous mobile phases to discourage bacterial growth
- Filter all samples, standards and mobile phases (eg. 0.2µm filter)
- Use an in-line filter system
- Perform sample clean-up on dirty samples

Please note that in cases of irreversible compound adsorption or column voiding, it may not be possible to regenerate the column.

Column Flushing

If a deterioration in column performance or increase in back pressure is observed, then a column cleaning or regeneration procedure can be undertaken, using a series of stronger solvent combinations. It is strongly advised to read the 'Care and Use' instructions provided by the manufacturer before commencing this procedure. While the majority of spherical 3, 5 and 10µm particle size columns can be reverse flushed or even used in the reverse direction, some 3µm columns can only be reverse flushed for a short time and should not be used in the reverse direction afterwards. For irregular particle columns, it is advisable to flush in the normal direction of flow.

For UHPLC (≤2µm) columns, the manufacturer's 'Care and Use' instructions must be consulted before considering reverse flushing the column. In some cases, it may be preferable to flush the UHPLC column in the normal direction of flow.

It is recommended that the column efficiency is measured before and after any clean-up procedure or long term storage, using either the column test conditions given on the manufacturer's test chromatogram or conditions from the method being followed. This enables the effectiveness of any cleaning procedure to be monitored.

Column Cleaning Procedures

The following general procedures are recommended for regeneration of column performance.

1. Disconnect and if applicable reverse the column.
2. Connect the column to the pump, but not the detector.
3. Follow the appropriate flushing procedure for the type of column (see page 219), using 10-20 column volumes of each solvent (see table below). Always make sure that the last solvent used will be compatible with the mobile phase.
4. The flow rate should not exceed that specified on the QC chromatogram for the particular column, but preferably should be maintained at 25-50% of the normal working flow rate.

Column Volumes (ml)

I.D.	Length	50mm	150mm	250mm
2.1mm		0.17	0.52	0.87
3.2mm		0.4	1.2	2.0
4.6mm		0.83	2.5	4.2
10.0mm		3.9	11.8	19.6
21.2mm		19.3	57.8	96.3

Column Cleaning, Regeneration and Storage of Silica Based Columns (continued)

Flushing Procedures for Various Types of Column

Reversed-phase columns

(eg. C18, C8, C4, Phenyl, CN, 'AQ' type)

- Mobile phase without buffer
- Methanol
- Acetonitrile
- Acetonitrile/IPA (75:25)
- IPA
- Dichloromethane
- Hexane

In many cases, the sequence a) to e) may be sufficient. If step f) or g) is necessary, flush with IPA before returning to mobile phase.

If metal ions are thought to be causing contamination, flush with aqueous 0.05M EDTA followed by water.

Columns which have been used with ion-pairing reagents are best dedicated to that method and kept for this purpose.

Reversed-phase columns used for protein/peptide analysis

- Mobile phase without buffer
- Gradient of 10 – 90% B where
A = 0.1% TFA in water
B = 0.1% TFA in acetonitrile

Unbonded silica columns (SIL)

- IPA
- Methanol
- Ethyl acetate

Bonded normal-phase columns

(CN, NH₂, Diol)

- Chloroform
- IPA
- Methylene chloride
- Hexane

Anion-exchange columns

(SAX, WAX)

- Water
- Methanol
- Chloroform
- Methanol
- Water

Cation-exchange columns

(SCX, WCX)

- Water (inject 4x 200µl DMSO during flush)
- Tetrahydrofuran

Size exclusion columns for proteins

For weakly retained proteins

- 0.1M phosphate buffer, pH 3

For strongly retained proteins

- Gradient of 100% water to 100% acetonitrile over 60 minutes

If you require further information on flushing procedures for specific columns, please contact the Technical Support group at Hichrom.

Storage conditions for silica based HPLC columns

The conditions under which a column is stored will affect its lifetime. All buffers, salts and ion-pairing reagents should be flushed from the column before storage. Ideally, the storage solvent should be as shown on the initial column test chromatogram provided by the manufacturer. Column end plugs (see page 188) should be fitted to prevent solvent evaporation and the subsequent drying out of the packing bed.

The following trademarks are the property of the listed company and/or its affiliates. Every effort has been taken to ensure that this list was accurate at the time of printing.

Acclaim	Thermo Fisher Scientific Inc.	MICRA	Eprogen, Inc.
Accucore	Thermo Fisher Scientific Inc.	MICROLITER	Hamilton Co.
ACE	Advanced Chromatography Technologies Ltd	MicroTight	IDEX Health & Science LLC
AKTA	GE Healthcare BioSciences AB	MonoSpin	GL Sciences, Inc.
All-Guard	Alltech Associates, Inc.	MonoTip	GL Sciences, Inc.
ALUGRAM	Macherey-Nagel GmbH & Co. KG	MonoTrap	GL Sciences, Inc.
Aluspher	Merck KGaA, Darmstadt, Germany	MRQ	MicroSolv Technology Corporation
AmyCoat	Akzo Nobel Pulp & Performance Chemicals	nanoViper	Thermo Fisher Scientific Inc.
ANALYTIC-BARRIER	Mitsubishi Chemical Corp.	Nova-Pak	Waters Corporation
AQ (Advanced Quality)	MicroSolv Technology Corporation	NUCLEOCEL	Macherey-Nagel GmbH & Co. KG
Aquapore	PerkinElmer, Inc.	NUCLEODEX	Macherey-Nagel GmbH & Co. KG
AquaSep	ES Industries	NUCLEODUR	Macherey-Nagel GmbH & Co. KG
Asahipak	Showa Denko K.K.	NUCLEOGEL	Macherey-Nagel GmbH & Co. KG
BioAssist	Tosoh Corporation	NUCLEOGEN	Macherey-Nagel GmbH & Co. KG
BioBasic	Thermo Fisher Scientific Inc.	NUCLEOSHELL	Macherey-Nagel GmbH & Co. KG
Bio-Bond	Dikma Technologies Inc.	NUCLEOSIL	Macherey-Nagel GmbH & Co. KG
µBondapak	Waters Corporation	NuTip	Glygen Corp.
Bottom-of-the-Bottle	IDEX Health & Science LLC	Obelisc	SIELC Technologies, Inc.
Brownlee	PerkinElmer, Inc.	OPTIMA	Macherey-Nagel GmbH & Co. KG
CAPCELL PAK	Shiseido Co. Ltd	OPTIMAPAK	RStech Corp.
CapRod	Merck KGaA, Darmstadt, Germany	Partisil	Hichrom Ltd
CelluCoat	Akzo Nobel Pulp & Performance Chemicals	Partisphere	Hichrom Ltd
ChiraDex	Merck KGaA, Darmstadt, Germany	PEEK	Victrex Plc
CHIRALCEL	Daicel Corporation	PEEKsil	SGE Analytical Science Pty Ltd
CHIRALPAK	Daicel Corporation	PepMap	Thermo Fisher Scientific Inc.
CHIRAMIX	T. Hasegawa Co. Ltd	PepSwift	Thermo Fisher Scientific Inc.
Chirobiotic	Sigma-Aldrich Co.	PLgel	Agilent Technologies Inc.
ChiroSil	RStech Corp.	PLRP-S	Agilent Technologies Inc.
CHROMABOND	Macherey-Nagel GmbH & Co. KG	POLYGRAM	Macherey-Nagel GmbH & Co. KG
CHROMAFIL	Macherey-Nagel GmbH & Co. KG	Primesep	SIELC Technologies, Inc.
CHROMAFIX	Macherey-Nagel GmbH & Co. KG	PrincetonSFC	Princeton Chromatography, Inc.
Chromegabond	ES Industries	PrincetonSPHER	Princeton Chromatography, Inc.
Chromolith	Merck KGaA, Darmstadt, Germany	ProPac	Thermo Fisher Scientific Inc.
Cogent	MicroSolv Technology Corporation	ProSwift	Thermo Fisher Scientific Inc.
Core Enhanced Technology	Thermo Fisher Scientific Inc.	ProTain	ZirChrom Separations, Inc.
Coresep	SIELC Technologies, Inc.	Purospher	Merck KGaA, Darmstadt, Germany
COSMOSIL	Nacalai Tesque	Reacti-Therm	Thermo Fisher Scientific Inc.
CROWNPAK	Daicel Corporation	Regis	Regis Technologies, Inc.
Cyclobond	Sigma-Aldrich Co.	Regisil	Regis Technologies, Inc.
Defender	Thermo Fisher Scientific Inc.	RegisCell	Regis Technologies, Inc.
Denali	Alltech Associates, Inc.	RegisPack	Regis Technologies, Inc.
Develosil	Nomura Chemical Co.	Resolve	Waters Corporation
DiamondBond	ZirChrom Separations, Inc.	RheBuild	IDEX Health & Science LLC
DNAPac	Thermo Fisher Scientific Inc.	Rheodyne	IDEX Health & Science LLC
DNASwift	Thermo Fisher Scientific Inc.	RSA	MicroSolv Technology Corporation
DryLab	Molnar-Institut, Germany	Sachtopen	Sachtleben Chemie GmbH
EBT	Advanced Chromatography Technologies Ltd	SeQuant	Merck KGaA, Darmstadt, Germany
Endeavorsil	Dikma Technologies Inc.	Sentry	Waters Corporation
Epic	ES Industries	Servo	Thermo Fisher Scientific Inc.
Eternity	Akzo Nobel Pulp & Performance Chemicals	SHARC	SIELC Technologies, Inc.
Everest	Alltech Associates, Inc.	Shodex	Showa Denko K.K.
Excel	Advanced Chromatography Technologies Ltd	SiliaSphere	Silicycle Inc.
Exsil	W.R. Grace & Co.-Conn.	SilTite	SGE Analytical Science Pty Ltd
FlashMaster	Biotage AB	Slipfree	Thermo Fisher Scientific Inc.
Fluophase	Thermo Fisher Scientific Inc.	SOLA	Thermo Fisher Scientific Inc.
FunCap	GL Sciences, Inc.	SolventTrak	Axiom Chromatography Inc.
Fused-Core	Advanced Materials Technology, Inc.	Spherisorb	Waters Corporation
GammaBond	ES Industries	Spursil	Dikma Technologies Inc.
GASTIGHT	Hamilton Co.	SuperC18	Advanced Chromatography Technologies Ltd
Genesis	W.R. Grace & Co.-Conn.	SuperPhenylHexyl	Advanced Chromatography Technologies Ltd
GL-Tip	GL Sciences, Inc.	Superspher	Merck KGaA, Darmstadt, Germany
GlycanPac	Thermo Fisher Scientific Inc.	Symmetry	Waters Corporation
Grace	W.R. Grace & Co.-Conn.	SymmetryShield	Waters Corporation
GraceSmart	Alltech Associates, Inc.	SynChropak	Eprogen, Inc.
GreenSep	ES Industries	Synchromis	Thermo Fisher Scientific Inc.
Guard-Pak	Waters Corporation	System AF	IDEX Health & Science LLC
HALO	Advanced Materials Technology, Inc.	Titansphere	GL Sciences, Inc.
Hibar	Merck KGaA, Darmstadt, Germany	TopTip	Glygen Corp.
HSC	Advanced Chromatography Technologies Ltd	TOYOPEARL	Tosoh Corporation
HYDRODEX	Macherey-Nagel GmbH & Co. KG	ToyoScreen	Tosoh Corporation
Hypercarb	Thermo Fisher Scientific Inc.	TRACE	Thermo Fisher Scientific Inc.
HyperSep	Thermo Fisher Scientific Inc.	TraceGOLD	Thermo Fisher Scientific Inc.
Hypersil	Thermo Fisher Scientific Inc.	TracePLOT	Thermo Fisher Scientific Inc.
Hypersil GOLD	Thermo Fisher Scientific Inc.	Trinity	Thermo Fisher Scientific Inc.
Impaq	Silicycle Inc.	TSKgel	Tosoh Corporation
InertCap	GL Sciences, Inc.	TYPE-C	MicroSolv Technology Corporation
InertSep	GL Sciences, Inc.	UltraCore	Advanced Chromatography Technologies Ltd
Inertsil	GL Sciences, Inc.	Ultrasphere	Hichrom Ltd
InertSustain	GL Sciences, Inc.	Ultron	Shinwa Chemical Industries
Inspire	Dikma Technologies Inc.	Uniguard	Thermo Fisher Scientific Inc.
Isco	Teledyne Isco Inc.	UPLC	Waters Corporation
Kromasil	Akzo Nobel Pulp & Performance Chemicals	Verify	Thermo Fisher Scientific Inc.
Last Drop	VICI Jour, VICI AG International	Viper	Thermo Fisher Scientific Inc.
Leapsil	Dikma Technologies Inc.	VisionHT	Alltech Associates, Inc.
LiChroCART	Merck KGaA, Darmstadt, Germany	Vydac	Alltech Associates, Inc.
LiChroprep	Merck KGaA, Darmstadt, Germany	Wakopak	Wako Chemicals GmbH
LiChrosorb	Merck KGaA, Darmstadt, Germany	Whelk-O	Regis Technologies, Inc.
LiChrospher	Merck KGaA, Darmstadt, Germany	ZIC	Merck KGaA, Darmstadt, Germany
LIPODEX	Macherey-Nagel GmbH & Co. KG	ZirChrom	ZirChrom Separations, Inc.
manu-CART	Merck KGaA, Darmstadt, Germany	ZORBAX	Agilent Technologies Inc.
MCI GEL	Mitsubishi Chemicals	ZWIX	Daicel Corporation

- ABBREVIATIONS, CHROMATOGRAPHIC** 215
- ACCLAIM** 152, 153
- ACCUCORE** 149
- ACE**
- ACE 300Å 67
 - ACE C18-AR 60
 - ACE C18-PFP 61
 - ACE Excel 58, 65, 66, 71
 - ACE SuperC18 59
 - ACE UltraCore 1
 - Columns 58-73
 - Pre-column filters 66
 - UHPLC column connector 66
- ACCESSORIES**
- Connectors 188-191
 - Detector lamps 203
 - Filters 193, 194
 - Fittings 188-191
 - Frits 192
 - Mixing tee 190
 - Rheodyne 195-202
 - Smart Caps 204, 205
 - Spanners 192
 - Syringes 203
 - Tubing 186, 187
 - Unions 190, 191
 - Vials 182-185
- AFFINITY PHASES**
- Column listing and Overview 50
 - ProPac 153
 - Shodex 142
 - Thermo 153
 - TSKgel 155
 - TOYOPEARL 155
- AGILENT TECHNOLOGIES**
- Lamps 203
 - ZORBAX 165, 166
- ALUMINA COLUMNS**
- Aluspher 110
 - ES Industries GammaBond 85
- APPLICATION SUPPORT** 7
- 'AQ' (HIGH AQUEOUS) PHASES** See Polar Embedded Phases
- ASAHIPAK** 139-142
- ASYMMETRY MEASUREMENTS** 10, 216
- BOOKS** 208-210
- BROWNLIEE (PERKIN ELMER)**
- MPLC cartridge columns 126
- BUFFER SELECTION** 24
- BULK HPLC MATERIALS** See Preparative and Process Scale
- CAPILLARY COLUMNS**
- Acclaim PepMap 153
 - ACE 69, 71, 72
 - GC 168-170
 - Overview 13
 - PolyLC 130
 - Vydac 90
 - ZIC-HILIC 109
 - ZIC-cHILIC 109
- CAPILLARY ELECTROPHORESIS (CE) COLUMNS**
- GL Sciences FunCap 174
 - MicroSolv 174
 - Overview 28
- CHIRAL COLUMNS**
- CHIRA-chrom 100
 - ChiraDex 110
 - CHIRALCEL 74
 - CHIRALPAK 74, 75
 - ChiroSil 137
 - Column listing 52, 53
 - CROWNPAK 75
 - DACH-DNB 136
 - Hichrom 100
 - NUCLEOCEL 102
 - NUCLEODEX 102
 - NUCLEOSIL 102
 - Overview 51
 - Pirkle 1-J 136
 - RegisCell 137
 - RegisPack 137
 - RESOLVOSIL 102
 - Shodex 142
 - ULMO 136
 - Ultron ES 158
 - Whelk-01 and 02 136
 - ZirChrom 163
 - ZWIX 75
- CHIRAL TECHNOLOGIES**
- CHIRALCEL 74
 - CHIRALPAK 74, 75
 - CROWNPAK 75
 - Immobilized phases 74
 - SFC columns 74, 75
- CHROMATOGRAPHIC**
- Abbreviations 215
 - Calculations 216
- CHROMEAGABOND** 85
- CHROMOLITH** 110
- COGENT** 115-120
- COLUMNS** See also individual brands
- Analytical 11
 - Capillary and nano 13
 - Cleaning and regeneration 218, 219
 - Coupler 188
 - Custom packed 8
 - End plugs 188
 - Evaluation 10
 - GC 168-170
 - LC-MS 14
 - Medium Bore 11
 - Microbore 12
 - Nano 13
 - Preparative and process scale 22, 23
 - Selection overview 29
 - Selection by USP specification 54-57
 - Superficially porous 16
 - UHPLC 15
- COLUMN CLEANING PROCEDURES** 218, 219
- CONNECTORS**
- Column coupler 188
 - Micro and nano fittings 191
 - PEEK 188, 190, 191
 - Slipfree 189
 - Stainless steel 189, 190
 - UHPLC 189
- CORE SHELL COLUMNS**
- See Superficially Porous Phases
- COSMOSIL** 76-79
- DAICEL** See Chiral Technologies
- DERIVATIZATION REAGENTS** 171

Index (continued)

- DEVELOASIL** 80, 81
- DIKMA TECHNOLOGIES**
- Bio-Bond 82, 83
- Endeavorsil 82, 83
- Leapsil 82, 83
- Inspire 82, 83
- Spursil 82, 83
- DRYLAB** 206, 207
- EFFICIENCY MEASUREMENTS** 10, 216
- ENRICHMENT COLUMNS**
- ACE 69
- ProSwift ConA-1S 153
- Titansphere 89
- EPROGEN** 84
- ES INDUSTRIES**
- AquaSep 85
- Chromegabond 85
- Epic 85
- FluoroSep-RP 85
- GammaBond Alumina 85
- GreenSep 85
- SFC columns 85
- EXSIL** 86
- EXTENDED pH PHASES** See also polymer columns
- Accucore C18 149
- ACE SuperC18 1, 59
- Hypersil GOLD 150
- InertSustain C18 & C8 87
- NUCLEODUR C18 & C8 Gravity 102
- FERRULES**
- GC 172
- HPLC 190
- Rheodyne 201
- FILTERS**
- Bottom-of-the-Bottle 193
- Inlet 193
- Inline 194
- Last Drop 193
- Precolumn 66, 194
- Preparative in-line 194
- UHPLC 194
- FINGERTIGHT**
- Column couplers 188
- Fittings 188
- High temperature 188
- PEEK connectors 188
- Ultra-high pressure (UHPLC) 189
- Viper fittings 189
- FITTINGS**
- High temperature 188
- PEEK fingertight 188
- UHPLC connector 189
- Viper 189
- FLUORINATED PHASES**
- Accucore PFP 149
- ACE C18-PFP 58, 61, 65, 71, 72
- Epic PFP-LB 85
- Fluophase 151
- FluoroSep-RP 85
- HALO PFP 91
- HALO-5 PFP 91
- Hypersil GOLD PFP 150
- Overview 41
- NUCLEODUR PFP 102
- NUCLEOSHELL PFP 102
- Partisphere TAC-1 122, 123
- PrincetonSPHER PFP 134
- PrincetonSPHER Fluoropropyl 134
- PrincetonSPHER Fluorooctyl 134
- Wakopak Fluofix 159
- FRITS**
- PEEK encapsulated stainless steel 192
- Stainless steel 192
- FUSED-CORE PHASES** See Superficially Porous Phases
- GC**
- Columns 168-170
- Derivatization reagents 171
- Digital flowmeter 173
- Ferrules 172
- Inlet supplies 172
- Leak detector 173
- Liners 172
- Septa 172
- USP column listing 167
- GEL FILTRATION**
- Column listing 49
- BioBasic 153
- Eprogen 84
- MCI GEL 108
- Overview 49
- PolyLC 127, 130
- Shodex 141, 142
- TSKgel 154
- GEL PERMEATION**
- Column listing 49
- Overview 49
- Shodex 142
- TSKgel 154
- GENESIS** 90
- GLOSSARY** 211-214
- GL SCIENCES**
- FunCap CE capillaries 174
- Inertsil 87-89
- InertSustain 87
- Smart Bags 176
- Titansphere 89
- GRACE**
- Everest 90
- Genesis 90
- GraceSmart 90
- VisionHT 90
- Vydac 90
- GRAPHITISED CARBON**
- Hypercarb 150
- Pipette tips 177
- GUARD CARTRIDGES**
- See also individual brands
- Guard cartridge design 20
- Starter kit 21
- HALO and HALO-5** 91
- HAMILTON**
- Syringes 203
- HICHROM**
- C8, C18 92-96
- Chiral 100
- Custom packed columns 8
- Fittings and accessories 188-191
- Guard cartridges 20, 21
- HiCap GC columns 168-170
- Hichrom training courses 9
- PAH2 99
- RPB 97, 98
- Technical services 6-9
- HIGH pH PHASES** See Extended pH Phases

Index (continued)

HILIC (HYDROPHILIC INTERACTION CHROMATOGRAPHY) PHASES

Acclaim	152
Accucore	149
BioBasic	153
Column listing	44
COSMOSIL	76, 78, 79
Epic	85
HALO	91
HALO-5	91
Hypersil GOLD	150
Inertsil	87, 88
NUCLEODUR	102
NUCLEOSHELL	102
Obelisc N	147
Overview	44
PolyLC	127, 128, 130
Synchronis	151
TSKgel Amide-80	155
VisionHT	90
ZIC-HILIC	109
ZIC-cHILIC	109
ZIC-pHILIC	109

HPLC

Books	208-210
Calculations	216
Glossary	211-214
USP column listing	54-57

HYDROPHOBIC INTERACTION (HIC) PHASES

Column listing	39
COSMOSIL	76, 79
MCI GEL	108
Overview	39
PolyLC	127, 130
ProPac	153
Shodex	142
TSKgel	155

HYDROPHOBICITY	30-32
-----------------------	-------

HYPERCARB	150
------------------	-----

HYPERSIL

Columns	151
Hypersil BDS	151
Hypersil GOLD	150

IDEX HEALTH AND SCIENCE	see pages 186-202
--------------------------------	-------------------

IMMOBILIZED ARTIFICIAL MEMBRANE (IAM)	137
--	-----

INERTSIL	87-89
-----------------	-------

ION CHROMATOGRAPHY

MCI GEL	107
Overview	48
Phases	48
Shodex	140

ION-EXCHANGE COLUMNS

BioBasic	153
Column listing	46, 47
COSMOGEL	79
Epic	85
Eprogen	84
Exsil	86
Hypersil GOLD	150
Inertsil	87-89
MCI GEL	107, 108
NUCLEOGEN	102
NUCLEOSIL	103, 104
Overview	46
Partisil	121-125
Partisphere	122, 123
PolyLC	127-130
ProPac and ProSwift	153
Shodex	140
TSKgel	155
Waters Spherisorb	160, 161
ZirChrom	162-164

ION PAIRING REAGENTS	137
-----------------------------	-----

LAMPS	203
--------------	-----

LC-MS COLUMNS See individual column brands

Overview	14
----------	----

L-COLUMN	101
-----------------	-----

LICHROPREP	114
-------------------	-----

LICHROSORB	111
-------------------	-----

LICHROSPHER	112, 113
--------------------	----------

MACHEREY-NAGEL

NUCLEOCEL	102
NUCLEODEX	102
NUCLEODUR	102
NUCLEOGEL SUGAR	102
NUCLEOGEN	102
NUCLEOSHELL	102
NUCLEOSIL	102, 103-106
RESOLVOSIL	102
Syringe filters	178
TLC plates	179, 180
Vials	185

MCI GEL (MITSUBISHI CHEMICALS)	107, 108
---------------------------------------	----------

MEDIUM BORE

Column overview	11
-----------------	----

MERCK MILLIPORE

Cartridge system	110
Chromolith	110
LiChrorep	114
LiChrosorb	111
LiChrospher	112, 113
Purospher	110
Purospher STAR	110
SeQuant ZIC-HILIC	109
TLC plates	181

METABOLOMICS

'Metabolomics' Column (Cogent Diamond Hydride)	116
Overview	26

METHOD DEVELOPMENT KITS

ACE	73
Cogent	116

METHOD TRANSFER	17-19
------------------------	-------

MICROBORE

Column overview	12
-----------------	----

MICROSOLV

CE capillaries	174
Cogent columns	1-4, 115-120
RSA Glass vials	182-184
Window Maker for CE	174

MIXED MODE COLUMNS

Acclaim	152
Coresep	3
GlycanPac	153
Obelisc	147
Primesep	143-146
Promix	146
SHARC	148

MONOLITHIC COLUMNS

Chromolith	110
DNASwift	153
PepSwift	153
ProSwift	153

NANO COLUMNS

ACE	69, 71, 72
Overview	13
Vydac	90

Index (continued)

ZIC-cHILIC	109
ZIC-HILIC	109

NOMURA See Develosil

NORMAL-PHASE

Column listing bonded phases	42, 43
Column listing non-bonded phases	45
Column selection overview	29

NUCLEODUR	102
------------------------	-----

NUCLEOSHELL	102
--------------------------	-----

NUCLEOSIL

Chiral	102
Columns	103-106

NUTS AND FERRULES

Stainless steel	190
-----------------------	-----

OBELISC	147
----------------------	-----

PAH ANALYSIS COLUMNS

Develosil PAHS	80, 81
Hichrom PAH2	99
Inertsil ODS-P	87
NUCLEODUR C18 PAH	102
Vydac 201TP	90

PARTISIL	121-125
-----------------------	---------

PARTISPHERE	122, 123
--------------------------	----------

PEEK

Connector	190, 191
Fingertight column coupler	188
Fingertight fittings	188
Static mixing tee	190
Tees and crosses	190
Tubing	186, 187
Tubing sleeves	191

PERKIN ELMER See Brownlee

PFP (PENTAFLUOROPHENYL) BONDED PHASES

See Fluorinated Phases

PHENYL BONDED COLUMNS

Acclaim	152
Accucore	149
ACE	58, 60, 71-73
Chromegabond	85
Cogent	115-120
Column listing	40
Develosil	80, 81
Genesis	90
Hypersil	151
Hypersil BDS	151
Hypersil GOLD	150
Inertsil	87-89
InertSustain	87
NUCLEOSIL	103-105
Overview	40
PrincetonSPHER	134
Synchronis	151
TSKgel	154
Vydac	90
Waters Spherisorb	160, 161
ZORBAX	165, 166

PHENYL-HEXYL BONDED COLUMNS

Accucore	149
ACE UltraCore SuperPhenylHexyl	1
Column listing and Overview	40
Epic	85
HALO	91
HALO-5	91
NUCLEODUR	102
NUCLEOSHELL	102

PIPETTE TIPS

NuTip	177
TopTip	177

POLAR BONDED COLUMNS

ACE	58, 63, 67, 71-73
Chromegabond	85
Column listing	42, 43
COSMOSIL	76
Develosil	80, 81
Exsil	86
Genesis	90
HALO	91
Hypersil	151
Hypersil GOLD	150
Inertsil	87, 88
InertSustain	87
LiChrosorb	111
LiChrospher	112, 113
NUCLEODUR	102
NUCLEOSIL	103-105
Overview	42, 43
Partisil	121-125
Partisphere	122, 123
PrincetonSPHER	134
Purospher STAR	110
Synchronis	151
TSKgel	154
Ultrasphere	156, 157
Waters Spherisorb	160, 161
ZORBAX	165, 166

POLAR EMBEDDED and OTHER 'AQ' RP PHASES

Acclaim PolarAdvantage	152
Accucore aQ	149
Accucore Polar Premium	149
ACE AQ	58, 64, 71, 72
ACE C18-Amide	58, 62, 71, 72
AquaSep	85
Chromegabond ODS-PI	85
Column listing	37
COSMOSIL C18-PAQ	76, 79
Develosil RPAQUEOUS	80, 81
Epic Polar	85
HALO RP-Amide	91
Hypersil GOLD aQ	150
Inertsil ODS-EP	87
NUCLEODUR C18 Pyramid	102
NUCLEODUR PolarTec	102
Overview	37
Spursil C18	82, 83
Synchronis aQ	151

POLARITY	30-32
-----------------------	-------

POLYLC

Columns	127-130
Pipette tips	177
SPE	130

POLYMERIC COLUMNS

COSMOGEL	79
DNAPac	153
MCI GEL	107, 108
ProPac	153
ProSwift	153
Shodex	138-142
TSKgel	154, 155

PREPARATIVE AND PROCESS SCALE

ACE	70
Column listing	23
Develosil	80
LiChroprep	114
MCI GEL	108
Overview	22, 23
PolyLC	130
Princeton	131, 133, 135
TOYOPEARL	155
Vydac	90

Index (continued)

- PRIMESEP** 143-146
- PRINCETON**
HPLC columns 134, 135
SFC columns 131-133
- PROTEIN and PEPTIDE COLUMNS (300Å)**
See Wide Pore Reversed-phase Columns
- PROTEOMICS**
Columns 25
Overview 25
- PUROSPHER and PUROSPHER STAR** 110
- REGIS**
Chiral columns 136, 137
GC derivatization reagents 171
Restricted Access Media 137
Immobilized Artificial Membrane 137
- RESTRICTED ACCESS MEDIA (RAM)** 137
- REVERSED-PHASE COLUMNS**
Acclaim 152
Accucore 149
ACE 58-73
ACE UltraCore 1
AquaSep 85
Characterisation of C18 phases 31, 32
Chromegabond 85
Chromolith 110
Cogent 115-120
Column listing for C1-C30 phases 33-36
Comparison of C18 phases 31, 32
COSMOSIL 76-79
Develosil 80, 81
Endeavorsil 82, 83
Epic 85
Eprogen 84
ES Industries 85
Exsil 86
Genesis 90
GraceSmart 90
HALO and HALO-5 91
HECTOR 2
Hichrom 92-99
Hypersil and Hypersil BDS 151
Hypersil GOLD 150
Inertsil 87-89
InertSustain 87
Inspire 82, 83
L-Column 101
Leapsil 82, 83
LiChrosorb 111
LiChrospher 112, 113
NUCLEODUR 102
NUCLEOSHELL 102
NUCLEOSIL 103-106
OPTIMAPAK 2
Partisil 121-125
Partisphere 122, 123
Phenyl-bonded 40
Polar bonded 42, 43
PrincetonSPHER 134
Selectivity of RP columns 30
Shodex 138
Spursil 82, 83
Specifications of C18 bonded materials 33, 34
Specifications of C1-C8 bonded materials 35, 36
Specifications of C30 bonded materials 36
Synchronis 151
TSKgel 154
Ultrasphere 156, 157
VisionHT 90
Vydac 90
Waters Spherisorb 160, 161
ZirChrom 162, 164
ZORBAX 165, 166
- RHEODYNE**
Accessories 200-202
MX Series II valves 195, 196
Sample Injectors 197, 198
Switching valves 199
- RSTECH**
HECTOR 2
INOPAK 2
OPTIMAPAK 2
- SACHTOPORE** 163
- SAMPLE PREPARATION**
Pipette tips 177
SPE 175
Syringe filters 178
TLC plates 179-181
- SAMPLING BAGS** 176
- SEALING PRODUCTS FOR 96 WELL PLATES**
RAPID EPS 1
RAPID Slit Seals 1
- SEC (SIZE EXCLUSION CHROMATOGRAPHY) PHASES**
Asahipak 142
BioBasic 153
Column listing 49
Eprogen 84
MCI GEL 108
Overview 49
PolyLC 127, 130
Shodex 141, 142
TSKgel 154
- SEQUANT**
ZIC-CHILIC 109
ZIC-HILIC HPLC columns 109
ZIC-pHILIC HPLC columns 109
- SFC (SUPERCRITICAL FLUID CHROMATOGRAPHY) COLUMNS**
COSMOSIL 79
Daicel 74, 75
ES Industries 85
Overview 27
Princeton 131-133
Regis 136, 137
- SHODEX** 138-142
- SIELC**
Obelisc 147
Coresep 3
Primesep 143-146
Promix 146
SHARC 1 148
- SILICA (NON-BONDED) PHASES**
ACE 58, 71, 72
Chromolith 110
Cogent TYPE-C 115-120
Column listing 45
COSMOSIL 76, 79
Exsil 86
Genesis 90
HALO HILIC 91
Hypersil 151
Hypersil GOLD 150
Inertsil 87
LiChrosorb 111
LiChrospher 112, 113
NUCLEODUR 102
NUCLEOSIL 102, 103-106
Overview 45
Partisil 121-125
Partisphere 122, 123
Purosphere STAR 110
Ultrasphere 156, 157
VisionHT 90

Index (continued)

- Waters Spherisorb 160, 161
 ZORBAX 165, 166
- SMARTCAPS** 204, 205
- SOLVENT PROPERTIES** 217
- SPE (SOLID PHASE EXTRACTION)**
 INOPAK 2
 PolyLC 130
 Principles 175
- SPHERISORB** 160, 161
- SUPERFICIALLY POROUS PHASES**
 Accucore 149
 Accucore XL 149
 ACE UltraCore 1
 Column listing 16
 Coresep 3
 HALO 91
 HALO-5 91
 NUCLEOSHELL 102
 Overview 16
- SWITCHING VALVES and INJECTORS (MANUAL)** 197-201
- SYNCHROPAK** See Eprogen
- SYNCRONIS** 151
- SYRINGES**
 Hamilton 203
 SGE 203
- SYRINGE FILTERS** 178
- TECHNICAL SEMINARS** 9
- TECHNICAL SERVICES** 6-8
- THERMO SCIENTIFIC**
 Acclaim 152, 153
 Accucore 149
 Accucore XL 149
 BioBasic 153
 DNAPac 153
 Fluophase 151
 GlycanPac 153
 Hypercarb 150
 Hypersil 151
 Hypersil GOLD 150
 Synchronis 151
 Viper fingertight fittings 189
- TITANIA COLUMNS**
 Overview 29
 Sachtopore 163, 164
 Titansphere 89
- TLC PLATES**
 Merck 181
 Macherey-Nagel 179, 180
- TOOLS**
 Cutters for PEEK tubing 187
 Cutters for stainless steel tubing 187
 Spanners 192
 ValvTool 192
- TOSOH BIOSCIENCE**
 Affinity phases 155
 Bulk resins 155
 HIC phases 155
 HILIC phases 155
 Ion-exchange phases 155
 Reversed-phase columns 154
 SEC phases 154
 TOYOPEARL 155
 ToyoScreen 155
- TOYOPEARL** 155
- TOYOSCREEN** 155
- TRADEMARKS** 220
- TRAP COLUMNS**
 Acclaim PepMap 153
 ACE 69
 Chromolith 110
 Overview 13
 Titansphere 89
- TUBING**
 Cutters for PEEK 187
 Cutters for stainless steel 187
 PEEK 187
 PEEKsil 187
 PTFE 187
 Stainless steel 186
- TYPE-C SILICA** 115-120
- UHPLC COLUMNS**
 ACE Excel 58, 65, 66, 71
 Column listing 15
 Endeavorsil 82, 83
 Epic 85
 Hypersil GOLD 150
 Inertsil 87
 InertSustain 87
 NUCLEODUR 102
 Overview 15
 Purospher STAR 110
 Synchronis 151
 VisionHT 90
 ZirChrom 163
- ULTRASPHERE** 156, 157
- ULTRON** 158
- UPCHURCH** see pages 186-194
- USP SPECIFICATIONS**
 GC 167
 HPLC 54-57
- VIALS, CAPS AND INSERTS**
 Macherey-Nagel 185
 MicroSolv RSA 182-184
- VYDAC** 90
- WAKOPAK FLUOFIX** 159
- WATERS SPHERISORB** 160, 161
- WIDE PORE (300Å) REVERSED-PHASE COLUMNS**
 Acclaim 152
 ACE 58, 67, 72, 73
 Aquapore 126
 BioBasic 153
 Bio-Bond 82, 83
 Cogent Bidentate 115, 120
 Column listing 38
 COSMOSIL 79
 Eprogen RP8 84
 Everest 90
 FluoroSep-RP Propyl 85
 NUCLEOSIL 103, 106
 Overview 38
 ProPac 153
 ProSwift 153
 TSKgel 154
 Vydac 90
- ZIRCHROM**
 Columns (zirconia phases) 162-164
 ProTain in-line protein removal 164
 Sachtopore 163
- ZORBAX** 165, 166

Governing Terms

These terms and conditions of sale (Terms) shall apply to all contracts for the sale and supply of products and services by Hichrom Ltd (Hichrom). Except as expressly agreed by authorized representatives of Hichrom in writing, no other terms and conditions, including any terms and conditions attached to the buyer's request for quotation, acknowledgement, purchase order or other contract documentation, shall apply to the sale. Each order for goods shall be considered to be an offer by the buyer to purchase the goods from Hichrom subject to these Terms and no order will be deemed to be accepted by Hichrom until a written acknowledgement of order is issued or the goods are delivered to the buyer (if earlier).

Delivery and Risk

Hichrom makes every effort to deliver all goods in a timely and cost efficient manner, but any dates specified for delivery of the goods are intended to be an estimate and time for delivery shall not be made of the essence by notice. Within the UK orders less than £500 in value will be delivered by first class post. Goods worth in excess of £500 will be dispatched via overnight courier service. If requested, urgent deliveries can be made by overnight or same day courier for an additional charge. Risk of loss for all UK orders will pass to the customer on arrival at the specified delivery address. In the case of orders for supply outside of the UK, risk of loss shall pass to the customer upon collection by the carrier.

Lost or Damaged Goods

In the case of orders for supply within the UK, Hichrom will make good or replace (at its option) all goods which are lost or damaged during transit, provided that notification of damage or non-delivery is received within 3 days after delivery in the case of damage, and within 7 days after receipt of invoice in the case of non-delivery.

Returns and Cancellation

Hichrom may, at its sole discretion, accept returns. Returns will only be accepted following prior authorization from Hichrom, after which they must be returned within 30 days. Hichrom is not liable for goods returned without authorization. Returns are subject to payment of a handling charge if required by Hichrom. Hichrom may at its sole discretion, accept cancellation of orders subject to a payment of a cancellation charge if required by Hichrom.

Title

Ownership of the goods will not pass to the buyer until Hichrom has received in full (in cash or cleared funds) all sums due to it in respect of the goods and all other sums which are or become due to Hichrom from the buyer on any account.

Prices

Unless otherwise agreed by Hichrom, the price for the goods shall be the price set out in Hichrom's published price list current as at the date of order. Hichrom reserves the right to change the published price list without notice. However, Hichrom will attempt to notify the customer for approval prior to shipment in the event of significant price changes. All prices are quoted exclusive of any value added tax and all costs of packaging, carriage and insurance all of which amounts the buyer will pay in addition at the appropriate rate at the time that payment for the goods or services is due. In addition, in the case of orders for supply outside the UK, the buyer is responsible for the payment of all taxes, charges, levies or duties of any kind payable on the supply of the goods. A minimum value of £50 (net of tax, packaging, carriage, insurance and all other charges which may apply) applies to all orders.

Payment

All invoices are payable in full in UK pounds sterling 30 days from the invoice date. Time for payment shall be of the essence and no payment shall be deemed to have been received until Hichrom has received cleared funds. Accounts outstanding for more than 60 days from invoice date may be placed on hold until payment is made. Hichrom may change credit or payment terms at any time when, in Hichrom's opinion, the customer's financial condition, previous payment record, or nature of customer's relationship with Hichrom so warrants. Hichrom reserves the right to place any account on a prepayment basis. Payment may be made by bank transfer, credit card or cheque.

Warranty

Hichrom warrants that, as at the date of delivery to the buyer, all products manufactured and distributed by Hichrom will meet Hichrom's publicly disclosed performance and quality standards, be free from defects in materials and workmanship and be of satisfactory quality within the meaning of the Sale of Goods Act 1994. For items distributed but not manufactured by Hichrom, the warranty is limited to the terms of the original manufacturer's warranty. For Hichrom manufactured products notification of any defect must be made to Hichrom within 90 days after delivery of the goods. At its discretion, Hichrom will replace products proven to be defective. If this is not achievable in a reasonable time, the buyer shall be entitled to a refund of the purchase price. This warranty shall not apply to any defect, failure or damage caused by the buyer's failure to follow Hichrom's oral or written instructions as to storage, use or maintenance of the goods or by any other improper use or improper or inadequate maintenance or care. Except as set out above, all warranties, conditions and other terms which may be implied by statute or common law are, to the fullest extent permitted by law, excluded from these Terms.

Limitation of Liability

Nothing in these Terms excludes or limits the liability of Hichrom for death or personal injury caused by Hichrom's negligence or for fraudulent misrepresentation. Subject to the first sentence of this paragraph, Hichrom shall not be liable to the buyer for any indirect or consequential liability, loss or damage (including without limitation, loss of profit, loss of business or depletion of goodwill), costs, expenses or claims for consequential compensation arising from the use of, or in conjunction with, the goods supplied. In addition, but subject to the first sentence of this paragraph, Hichrom's total liability in contract, tort (including negligence or breach of statutory duty), misrepresentation or otherwise arising in connection with the performance or contemplated performance of this contract will be limited to the invoice price of the product.

Severance

If any provision of these Terms is found by any court or other authority of competent jurisdiction to be invalid or unenforceable in whole or in part, it will be deemed severable and the remainder of such provision will continue in full force and effect.

Governing Law

All contracts incorporating these Terms shall be subject to English law and the exclusive jurisdiction of the English courts.

HICHROM

Chromatography Technical Advice Desk

Contact our experts on any chromatography issue for friendly, no obligation, free of charge, professional support and advice:

- Troubleshooting
- Method development
- Reproducibility advice
- Column identification
- Batch reservation
- Column selection
- Method optimisation
- Application support
- Cost reduction
- Custom packing
- Method transfer
- Custom bonding



Contact us on +44 (0)118 930 3660
or technical@hichrom.co.uk

HICHROM

worldwide...



- Algeria
- Argentina
- Armenia
- Australia
- Austria
- Bahamas
- Bangladesh
- Barbados
- Belarus
- Belgium
- Belize
- Bolivia
- Bosnia
- Brazil
- Bulgaria
- Canada
- Chile
- China
- Colombia
- Costa Rica
- Croatia
- Cyprus
- Czech Rep
- Denmark
- Dominican Rep
- Egypt
- El Salvador
- Estonia
- Ethiopia
- Finland
- France
- Germany
- Greece
- Guatemala
- Hong Kong
- Honduras
- Hungary
- Iceland
- India
- Indonesia
- Iraq
- Ireland
- Israel
- Italy
- Jamaica
- Japan
- Jordan
- Korea
- Kosovo
- Kuwait
- Latvia
- Lebanon
- Lithuania
- Luxembourg
- Macedonia
- Malaysia
- Malta
- Mexico
- Morocco
- Netherlands
- New Zealand
- Nicaragua
- Nigeria
- Norway
- Oman
- Pakistan
- Panama
- Paraguay
- Peru
- Philippines
- Poland
- Portugal
- Puerto Rico
- Qatar
- Romania
- Russia
- Saudi Arabia
- Serbia
- Singapore
- Slovakia
- Slovenia
- South Africa
- Spain
- Sri Lanka
- Sweden
- Switzerland
- Taiwan
- Thailand
- Trinidad
- Tunisia
- Turkey
- UAE
- Uganda
- Ukraine
- Uruguay
- USA
- US Virgin Islands
- Venezuela
- Vietnam
- Zimbabwe

Hichrom products are available worldwide through our International Network of Distributors...



Hichrom Limited, 1 The Markham Centre, Station Road, Theale, Reading,
Berkshire, RG7 4PE, UK Tel: +44 (0)118 930 3660 Fax: +44 (0)118 932 3484
email: sales@hichrom.co.uk www.hichrom.co.uk