



# OPTIMIZE

CHROMATOGRAPHY FOR THE WORLD SINCE 1985

13993 Fir Street  
Oregon City, OR 97045  
TF: 800-669-9015  
Tel: 503-557-9994  
Fax: 503-557-9995  
[www.optimize-tech.com](http://www.optimize-tech.com)

OPTIMIZE TECHNOLOGIES



We are continually developing new products to meet the needs of our customers.

For the complete Optimize product line including items not featured in this publication, please contact us directly or visit [www.optimize-tech.com](http://www.optimize-tech.com).

We look forward to helping you.

**Cover Image:**

Candyland (2007) : Painted Hills, Oregon  
Photography by Marc Adamus  
[www.marcadamus.com](http://www.marcadamus.com)



## OPTIMIZE TECHNOLOGIES

is dedicated to providing the highest quality HPLC, UHPLC and LC/MS products available. We combine innovative design and superior performance to create products that are straight forward, yet elegant, solutions to daily issues in the lab.

For example, the EXP product family provides reusable hand-tight connections and cartridge replacement for UHPLC pressures of 20,000+ psi. The OPTI-LYNX system provides low-dispersion quick-connect capabilities for many applications rated to 6,000 psi. Our piston seals employ unique polymer blends to provide the ultimate performance. Check valve ball and seat sets are perfectly mated and feature optimized geometry for the fastest response time and flawless operation.

## SERVICE

We are constantly developing new products and expanding existing offerings. Please contact us if you have a custom design requirement or need support with your scientific instrumentation. Optimize welcomes the opportunity to provide custom designs and engineering solutions.

We promise to bring you innovative products that offer unmatched performance, quality, and ease of use - all backed with the most responsive and effective customer service in the industry.

Thank you for your business.

## OUR BRANDS

**EXP®**  
UHPLC Fittings,  
Filters, Traps, Guards  
and Analytical Columns



**OPTI-LYNX™**  
Quick-Connect  
Filters, Traps & Guards



**OPTI-LOK™**  
Fittings



**OPTI-PEEK™**  
Tubing



**OPTI-SOLV®**  
Filtration



**OPTI-TRAP™**  
Trap Columns



**OPTI-GUARD®**  
Guard Columns



**OPTI-MAX®**  
Check Valves



**OPTI-SEAL®**  
UHMW-PE Seals



**ITB™**  
PTFE Seals



**UHP**  **ULTRA HIGH PRESSURE**  
20,000psi / 1,400bar

**HP**  **HIGH PRESSURE**  
6,000psi / 400bar

**MP**  **MEDIUM PRESSURE**  
1,500psi / 100bar

**LP**  **LOW PRESSURE**  
>1000psi / >70bar



Optimize Technologies' new state-of-the-art manufacturing facility opened Fall 2019 in Oregon City, Oregon.



## We are Optimize Technologies

At Optimize, customer service isn't just a department—it's who we are. We are sales and quality assurance professionals, technical support specialists, machinists, engineers and chemists. We are here to support customers every step of the way. Optimize is committed to delivering innovative products that provide optimal performance.

OPTIMIZE  
TECHNOLOGIES



Innovative **HPLC**,  
**UHPLC** and **LC/MS**  
products proudly  
designed and  
manufactured in  
Oregon since 1985

## OPTIMIZE PROFILE

---

- 1 | **Optimize** Manufacturing
- 2 | **Optimize** Custom Products
- 3-4 | Innovation Spotlight: **EXP**<sup>®</sup>
- 5-6 | Innovation Spotlight: **OPTI-LYNX**<sup>™</sup>

## FITTINGS, ADAPTERS & TUBING

---

- 7-8 | Introduction
- 9 | **OPTI-LOK**<sup>™</sup> Low Pressure Fittings
- 10 | **OPTI-LOK**<sup>™</sup> High Pressure Fittings
- 11 | OEM Specific Fittings
- 12 | **OPTI-LOK**<sup>™</sup> Adapters
- 13-14 | **EXP**<sup>®</sup> & **EXP**<sup>®2</sup> UHPLC Fittings
- 15-19 | **EXP**<sup>®2</sup> TI-LOK<sup>™</sup> Fittings
- 17-19 | **EXP**<sup>®2</sup> TI-LOK<sup>™</sup> Adapters
- 19 | **EXP**<sup>®2</sup> TI-LOK<sup>™</sup> DIY  
Fittings & Adapter Kits
- 20 | Tubing and Tubing Cutters

## FILTRATION

---

- 21-22 | Introduction
- 23 | **OPTI-SOLV**<sup>®</sup> Solvent Reservoir Filters
- 24 | **OPTI-SOLV**<sup>®</sup> In-Line Filter
- 25 | **OPTI-SOLV**<sup>®</sup> Mini Filter
- 26 | **OPTI-SOLV**<sup>®</sup> Micro and Nano Filters
- 27 | **EXP**<sup>®2</sup> Stem Filter
- 28 | **EXP**<sup>®</sup> & **EXP**<sup>®2</sup> Pre-Column  
and In-Line Filters

Multnomah Falls, Oregon

## TRAP COLUMNS

---

29-30	Introduction
31	OPTI- <b>TRAP</b> <sup>™</sup> Trap Column
32	OPTI- <b>LYNX</b> <sup>™</sup> Micro Trap
33-34	<b>EXP</b> <sup>®2</sup> Nano Trap
35-36	<b>EXP</b> <sup>®2</sup> Stem Trap
37-38	<b>EXP</b> <sup>®</sup> Trap Column

## GUARD COLUMNS

---

39-40	Introduction
41	OPTI- <b>GUARD</b> <sup>®</sup> 1mm Guard Column
42	<b>EXP</b> <sup>®</sup> Guard Column

## ANALYTICAL COLUMNS

---

43	<b>EXP</b> <sup>®</sup> Analytical Columns
----	--

## BACK PRESSURE REGULATORS

---

44	Optimize Back Pressure Regulators
----	-----------------------------------

## OEM REPLACEMENT PARTS

---

45-46	Introduction
47-49	OPTI- <b>MAX</b> <sup>®</sup> Check Valves
50	OPTI- <b>MAX</b> <sup>®</sup> Check Valve Replacement Cartridges
51	Seals and Pistons
52	Seal Form Tools
53-54	OPTI- <b>MAX</b> <sup>®</sup> Conversion Kits
55-73	Instrument Specific Products
74	Custom Innovation

## LC TRAPPING

---

75-76	Introduction
77-78	Sample Pre-Concentration
79-80	Detergent Removal
81-87	Trap Specifics
81	Small Molecule
82	Peptide
83	Protein
84	SDS
85	NID
86	SCX
87	ISRP

## RESOURCES

---

88	Patents & Trademarks
89-90	Index
91	Ordering

## OPTIMIZE MANUFACTURING PRECISION MACHINING

Optimize products are manufactured by skilled machinists at our facility in Oregon City, Oregon. To meet exacting standards for quality and reliability, our designs push the limits of manufacturing tolerances. To achieve these dimensional tolerance controls, we individually machine components and avoid mold-based manufacturing techniques. We ensure the consistency of our manufacturing process with a rigorous quality control program.

### THE DRIVING FORCE

Innovation started Optimize and innovation continues to fuel our progress. The Auto-Adjusting Stem, Hand-Tight EXP hardware rated to 20,000 psi, OPTI-MAX check valve components and the OPTI-LYNX quick-connect system exemplify our commitment to the highest quality products. We push the limits of excellence in everything we create.

### RESEARCH & DEVELOPMENT

At Optimize, we are committed to research and development. Our team of engineers and chemists are constantly engaging in the evaluation of existing product designs and the conceptualization of new products. Our collaborative efforts with original equipment manufacturers (OEMs) and pharmaceutical research companies have resulted in customized components and devices for unique applications.

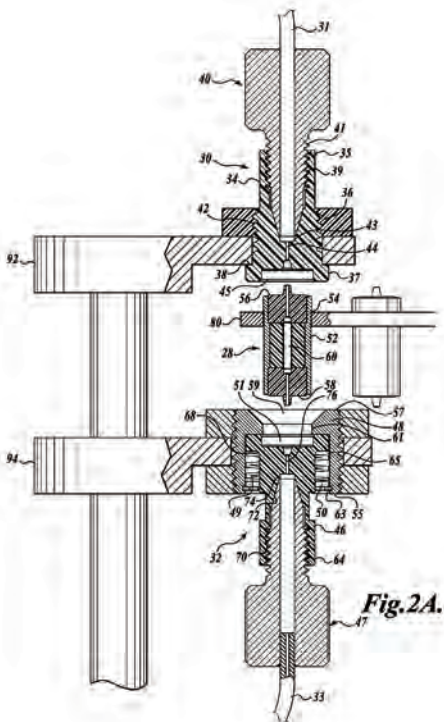
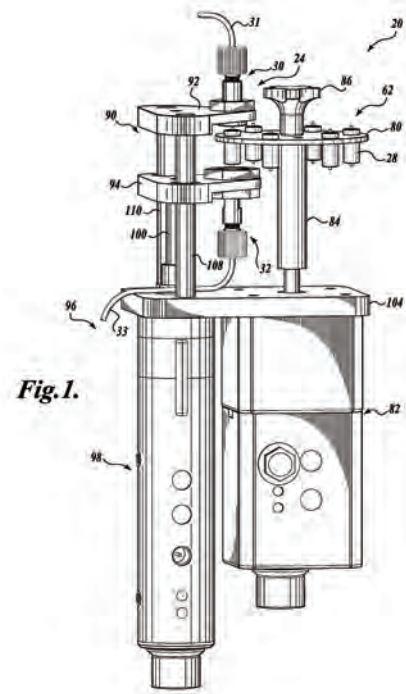



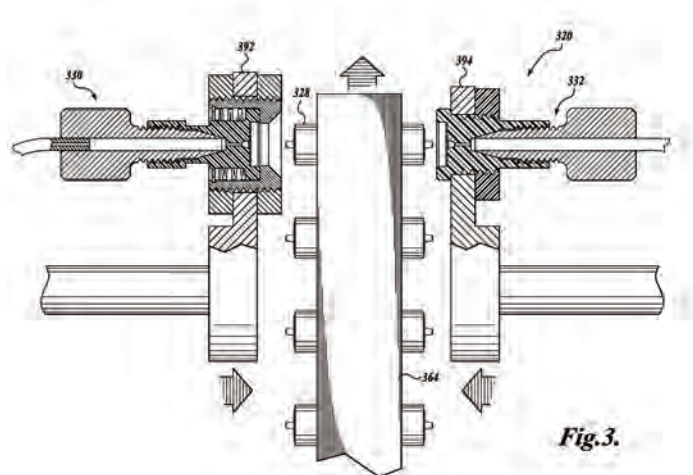

Some of the industries we serve

- Chromatography
- Drug Discovery
- Mass Spectrometry
- Nuclear Pharmacy
- Clinical
- Environmental
- Petrochemical
- Biodefense
- Pharmaceuticals

## CUSTOM DESIGN & MANUFACTURING

### SPECIFIC NEEDS, SPECIFIC RESULTS

Team with Optimize Technologies to bring your ideas to reality. From simple one-piece fittings to entire fluid handling assemblies – no project is too small or too large. Optimize specializes in custom design and development services including packed-bed products, quick-connect technology and complex fluid handling devices. Offering patented features such as EXP, OPTI-LYNX and OPTI-SOLV, we are able to customize existing products and design new solutions to meet your specifications.

Virtually all products are manufactured and designed in Oregon, USA. On-site engineering and manufacturing allows us to make rapid changes during the production process to meet the needs of our customers. Highly experienced machinists bring to life the innovations created by a team of design specialists, engineers and chemists. Our quality assurance professionals have a reputation for being the most demanding in the field, ensuring all Optimize products meet or exceed the highest standards in the industry.

## OPTIMIZE PARTNERS

### SEE WHAT OUR CUSTOMERS ARE SAYING

Our partnerships continue to benefit a variety of companies and customers with diverse applications. Optimize is the perfect partner to adapt existing designs to specific applications, to engineer solutions for problematic situations and create innovative products. To see what our customers are saying, please visit our website, [www.optimize-tech.com/testimonials](http://www.optimize-tech.com/testimonials).



The gold standard  
of extreme pressure  
chromatography hardware  
and consumables.

UHPLC

# EXP<sup>®</sup>

From the name you've trusted for over 30 years of precision innovation in HPLC accessories and consumables, EXP represents the culmination of a generation of research and development. High standards consistently guarantee that every product bearing the EXP trademark exemplifies our quality control, responsive customer service and expert technical support.

## EXTREME PRESSURE

Optimize Technologies' EXP product family includes fittings, filters and packed-bed products which offer unparalleled convenience and ease of use through exciting new patented and patent-pending innovations. This advanced system is the first design to provide reusable hand-tight connections and hand-tight cartridge replacement for UHPLC. The innovations significantly accelerate challenging UHPLC applications and reduce costly instrument downtime.

## REVOLUTIONARY FEATURES:

- EXP titanium/PEEK hybrid ferrule offering repeated zero-dead-volume connections, hand-tight to 8,700 psi or wrench-tight to 20,000 psi (1,400+ bar).
- EXP holders and cartridges with ultra-low internal swept volume and hand-tight cartridge changeover for use to 20,000 psi (1,400+ bar).
- New EXP2 TI-LOK Fittings, Adapters and Stem Holders now incorporate integral ferrules. No separate front-end ferrules to lose.

Our EXP components provide excellent protection with negligible impact on analyte retention and peak symmetry. The elegant design of the EXP line showcases sleek architecture for easy installation in restricted instrument compartments without compromising accessibility. Our commitment to exceed industry standards yields an entire EXP product family conservatively rated to 20,000+ psi (1,400+ bar). The EXP product line is designed and manufactured in our facility in Oregon, USA.

100% of all Optimize EXP products are made in the USA from materials originating in the USA.  
98% of all Optimize products are made in the USA from materials originating in the USA.

# EXP® TITANIUM HYBRID FERRULE TECHNOLOGY

## THE FOUNDATION OF THE EXP® FAMILY

Optimize Technologies recognizes the challenges faced by scientists and technicians in the constantly evolving field of chromatography and LC instrumentation. Ultra high pressure liquid chromatography presents an opportunity for innovative products.

In response to evolving UHPLC technologies, Optimize created the EXP Titanium PEEK Hybrid Ferrule. The EXP and EXP2 Ferrule adjusts to any 10-32, 6-40 or 6-32 port depth and can subsequently be removed and reused in a different port while still maintaining adjustability. The ferrule provides the necessary zero-dead-volume seal to allow connections beyond 20,000+ psi (1,400+ bar).

The EXP Ferrule is incorporated into the entire EXP product line, offering a wide array of applications. At Optimize, we strive to develop new products that are straight forward, yet elegant, solutions to daily issues in the lab.

## A PERFECT SEAL WITH EVERY CONNECTION

Original **EXP®**  
Ferrule for  
Stainless Steel

**EXP®2** TI-LOK™  
Integral Ferrule  
for all tubing



Pre-Assembly  
(exploded view)



### PEEK

Proven sealing ability  
beyond 20,000+ psi  
(1,400+ bar).



### TITANIUM

Enables the swage to be  
released and reset.  
Intended for many repeat  
connections.

## Advantages of the Original **EXP®** Ferrule

- Rated to 20,000+ psi (1,400+ bar)
- Tested to 30,000 psi
- No need to cut tubing to replace a swaged ferrule
- Auto-adjusting ZDV connection
- Intended for many repeat uses

## Advantages of the **EXP®2** TI-LOK Integral Ferrule

- All of the Original EXP Ferrule benefits (listed above)
- Perfect for all tubing including PEEKsil, PEEK and Fused Silica Tubing
- Inverted Titanium Hybrid Ferrule geometry prevents delamination of PEEKsil tubing by bottom-of-the-port sealing
- New EXP2 TI-LOK Fittings, Adapters and Stem Holders now incorporate integral ferrules. No separate front-end ferrules to lose.



**ULTRA HIGH PRESSURE**  
20,000+psi / 1,400+bar

## A REVOLUTIONARY QUICK-CONNECT SYSTEM

- Hand-tight quarter-turn holder closure design
- Low volume/low dispersion interface for volume critical regions
- True zero-dead-volume connection
- In-line and direct-connect holder configurations
- Holder hardware is only plumbed once
- Hand-tight no tools needed
- Simple, innovative and easy to use

### VERSATILITY

OPTI-LYNX was the first to introduce a low dispersion quick-connect system for HPLC and LC/MS. It is the most efficient solution for high-throughput and single instrument laboratories alike. The system is simple, fast and easy to use.

The OPTI-LYNX System is a modular design providing the maximum in versatility for your instrument. OPTI-LYNX inserts are available as filters, guard columns, trap columns or analytical columns. The holder's end-caps feature interacting surfaces that are identical, with the holder tube as the only variable component. Install a guard column for one application and simply switch to a pre-column filter for the next. Use an in-line filter with different porosities and diameters just by changing the insert. Make and break flow paths for multiple applications or anywhere a break in flow is frequently required. OPTI-LYNX allows flexibility without the hassle of changing basic components.

At Optimize, our goal is to deliver ideal solutions to individual applications. For example, beyond HPLC, OPTI-LYNX is ideal for high temperature GPC and position-emitting radionuclide filtration. OPTI-LYNX is designed as a hardware platform to make applications easier and more efficient. For special OPTI-LYNX stationary phase requirements, custom dimensions or configurations, please contact us.



OPTI-LYNX MICRO

OUR BEST IDEAS COME FROM  
THE NEEDS OF OUR CUSTOMERS

---



To change an OPTI-LYNX™ Insert, simply twist the holder  
- no tools required.

## HOW IT WORKS

With OPTI-LYNX, all it takes is a quarter-turn by hand to make or break tubing connections instantly. To make an OPTI-LYNX connection, two components - a slotted side and a pinned side - come together encapsulating the polymeric insert. The OPTI-LYNX System is useful and versatile because the polymeric insert can be a filter, trap column, guard column or even an analytical column. Almost any component in the HPLC flow path can be configured into an OPTI-LYNX insert.

"Problems with consistency and column longevity have been virtually eliminated since we started using OPTI-**LYNX** products. The Quick-Connect design makes changing columns fast and easy, eliminating the need for any tools."

Partner: Pfizer

## FITTINGS, ADAPTERS & TUBING

Optimize offers a variety of compression fittings, adapters and tubing for making low, high and ultra high pressure LC connections. OPTI-LOK LP 1/4-28 fittings are the best choice for connecting into flat-bottomed low pressure ports. For high pressure applications, OPTI-LOK 6K fittings are ideal for making solid, secure connections into any 10-32 port.

In response to evolving UHPLC technologies, Optimize delivers with the EXP Titanium PEEK Hybrid Ferrule. The ingenuity of the EXP and EXP2 Ferrule is designed to adjust to any 10-32, 6-40 or 6-32 port depth and can be removed and reused in a different port while still maintaining adjustability. The ferrule provides the necessary zero-dead-volume seal to allow connections beyond 20,000+ psi (1,400+ bar).

Our fittings and adapters are individually machined, never molded. Each fitting is individually inspected for the highest quality in the finished product. This process ensures consistent threading into fitting ports and longer thread life.

We also offer high and low pressure tubing in a number of diameters. Our stainless steel tubing is available pre-cut in a variety of lengths. Polymeric tubing can be purchased in bulk lengths and cut to size. We offer polymeric tubing in PEEK, PTFE and other materials.



## GUIDE TO OPTIMIZE FITTINGS

	OPTI-LOK™	OPTI-LOK™	OEM	OPTI-LOK™	EXP*	EXP*2
	LP Fittings	6K Fittings	Fittings	Adapters	UHPLC Fittings	UHPLC Fittings & Adapters
	Pg. 9	Pg. 10	Pg. 11	Pg. 12	Pg. 13-14	Pg. 13-19
Maximum Pressure	 <b>LOW PRESSURE</b> > 1000 PSI / > 70 BAR	 <b>HIGH PRESSURE</b> 6K PSI / 400 BAR	 <b>HIGH PRESSURE</b> 6K PSI / 400 BAR	 <b>HIGH PRESSURE</b> 6K PSI / 400 BAR	 <b>ULTRA HIGH PRESSURE</b> 20K+ PSI / 1400+ BAR	 <b>ULTRA HIGH PRESSURE</b> 20K+ PSI / 1400+ BAR
Thread Type(s)	1/4 - 28 M6 Metric	10 - 32 M6 Metric	1/4 - 28 10 - 32	1/4 - 28 10 - 32 Luer M6	6 - 32 6 - 40 10 - 32	6 - 32 6 - 40 10 - 32
Compatible Tubing Sizes (OD)	1/16" .100" 1/8"	1/16"	1/16"	Various	360µm 1/32" 1/16"	360µm 1/32" 1/16"
Hand-Tight	✓	✓	✓	✓	✓	✓
Products	Nuts Ferrules Unions Tees Plugs	Wrench-Tight Options Available	Wrench-Tight Options Available	Nuts Ferrules Unions Compression Screws	Adapters	Wrench-Tight Options Available
Materials	PEEK ETFE PTFE PCTFE Acetal	Nuts with Integral Ferrules Nuts Ferrules Couplers Unions Tees Plugs	PEEK Stainless Steel	PEEK	Nuts Ferrules Couplers	Nuts with Integral Ferrules
	PEEK ETFE PTFE PCTFE Acetal	PEEK PCTFE Acetal Stainless Steel	PEEK Stainless Steel	PEEK	Titanium PEEK Stainless Steel	Titanium PEEK Stainless Steel

# OPTI-LOK™ LOW PRESSURE FITTINGS

OPTI-LOK LP Fittings are an excellent choice for making low-pressure connections into 1/4-28 ports. Connections to flat-bottomed ports can be made using OPTI-LOK flat-bottomed ferrules for 1/16" or 1/8" tubing without the need for pre-flanged tubing ends. OPTI-LOK LP Fittings are precision machined to deliver leak-free, zero-dead-volume connections every time. We also offer 1/4-28 unions in various through-hole sizes for joining flat-bottom fittings.

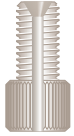

Nut (PEEK)

### OPTI-LOK™ LP 1/4-28 Nuts & Ferrules for 1/16" OD Tubing

<b>10-21-00290</b>	Nut, PEEK	<b>10-21-00293</b>	Nut, White Acetal
<b>10-21-00292</b>	Nut, ETFE	<b>10-21-00299</b>	Nut, PTFE
<b>10-21-00291</b>	Nut, Long, PEEK	<b>10-21-00296</b>	Ferrule, PEEK
<b>10-21-00295</b>	Ferrule, ETFE	<b>10-21-00300</b>	Ferrule, PTFE



Ferrule (PEEK)

### OPTI-LOK™ LP 1/4-28 Nuts & Ferrules for .100" OD Tubing

<b>10-21-00283</b>	Nut, White Acetal	<b>10-21-00284</b>	Nut, PEEK
<b>10-21-00281</b>	Ferrule, ETFE		

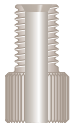

Nut (PEEK)

### OPTI-LOK™ LP 1/4-28 Nuts & Ferrules for 1/8" OD Tubing

<b>10-21-00307</b>	Nut, PEEK	<b>10-21-00305</b>	Nut, Black Acetal
<b>10-21-00310</b>	Nut, White Acetal	<b>10-21-00306</b>	Nut, PCTFE
<b>10-21-00309</b>	Nut, ETFE	<b>10-21-00317</b>	Nut, PTFE
<b>10-21-00308</b>	Nut, Long, PEEK	<b>10-21-00313</b>	Ferrule, PEEK
<b>10-21-00312</b>	Ferrule, ETFE	<b>10-21-00318</b>	Ferrule, PTFE



Union (PEEK)

### 1/4-28 Unions

<b>10-21-00323</b>	Union, PEEK
<b>10-21-00343</b>	Union, Knurled with wrench-flat, .050" Thru, PEEK

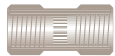

Union (PEEK)

### 1/4-28 Tee for 1/16" OD Tubing

<b>10-21-00286</b>	Tee, .062" Thru, PEEK
--------------------	-----------------------

### OPTI-LOK™ LP 1/4-28 Plug

<b>10-21-00326</b>	Plug, PTFE
--------------------	------------



Plug (PTFE)

## OPTI-LOK™ M6 METRIC NUTS & FERRULES

### OPTI-LOK™ LP Metric Fittings for 1/16" OD Tubing

<b>10-22-00297</b>	Nut, White Acetal	<b>10-22-00301</b>	Ferrule, Short, ETFE
--------------------	-------------------	--------------------	----------------------



Double Tight Ferrule (PEEK)

### OPTI-LOK™ LP Metric Fittings for 1/8" OD Tubing

<b>10-22-00314</b>	Nut, White Acetal	<b>10-22-00315</b>	Nut, Black Acetal
<b>10-22-00319</b>	Ferrule, Short, ETFE		

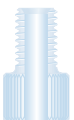

Nut (White Acetal)



# OPTI-LOK™ HIGH PRESSURE FITTINGS

OPTI-LOK Fittings are ideal for high-pressure connections with 1/16" OD tubing. All Optimize fittings are precision machined for optimal quality and thread consistency and are designed for trouble-free operation at pressures of up to 6,000 psi.

## OPTI-LOK™ I 10-32 Hand-Tight Fittings with Integral Ferrule

SINGLES	10 PACK	
10-20-00258	10-20-00259	OPTI-LOK I, PCTFE
10-20-00264	10-20-00265	OPTI-LOK I, PEEK

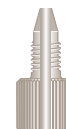

OPTI-LOK I (PEEK)

## OPTI-LOK™ 6K 10-32 Nuts & Ferrules

SINGLES	10 PACK	
<b>Nut Only</b>	<b>With Ferrules</b>	
10-20-00268	10-20-00270	Knurled Head, PEEK
10-20-00271	10-20-00272	Hex Head, Short, PEEK
10-20-00275	10-20-00276	Hex Head, Long, PEEK
10-20-00273	10-20-00274	Knurled Head, with wrench-flat, SS
SINGLES	10 PACK	
10-20-00269	10-20-00518	Double Tight Ferrule, PEEK

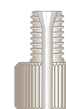

6K Knurled Head (PEEK)



6K Hex Head, Short (PEEK)



6K Knurled Head (SS)



Ferrule (PEEK)



Double Tight Ferrule (PEEK)

## 10-32 Couplers with 1/16" OD x .006" ID x 6cm SS Tubing

10-20-00263	Coupler, PCTFE
10-20-00266	Coupler, PEEK

## Universal 10-32 Nuts & Ferrules for 1/16" OD Tubing

10-24-00367	Universal Nut, SS
10-24-00369	Universal Ferrule, SS
10-24-00370	Universal Ferrule, PEEK
10-24-00376	Universal SS Nuts with SS Ferrules, 10/Pk



Universal Nut (SS)

## 10-32 Unions for 1/16" OD Tubing

10-20-00261	PEEK Union, .010" Thru
10-20-00262	PEEK Union, .020" Thru
10-24-00375	Universal Union, with Nuts & Ferrules, .010" Thru, SS
10-24-00373	Universal Union, with Nuts & Ferrules, .020" Thru, SS
10-24-00371	Universal Union, with Nuts & Ferrules, .030" Thru, SS

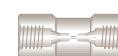

Union (PEEK)

## 10-32 OPTI-LOK™ Plugs

SINGLES	10 PACK	
10-20-00251	10-20-00253	Plug, White Acetal
10-20-00255	10-20-00256	Plug, PEEK



Tee (PEEK)



Plug (White Acetal)

# OEM SPECIFIC FITTINGS

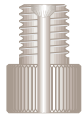

6K Nut  
(PEEK)



Double Tight  
Ferrule  
(PEEK)



Nut (SS)



Ferrule  
(PEEK)



Union  
(SS)



Ferrule  
(SS)

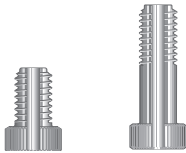

Nut  
(SS)



Nut, Long  
(SS)



Ferrule  
(SS)



Union (SS)



Ferrule (PEEK)



Ferrule  
(SS)

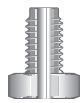

Compression  
Screw (SS)

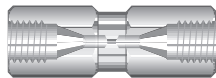

Union  
(SS)



Ferrule  
(PEEK)

## SSI-Style 1/4-28 Fittings for 1/16" OD Tubing

<b>10-20-00330</b>	6K Nut, PEEK
<b>10-20-00331</b>	6K Nut & Ferrules, PEEK, 10/Pk
<b>10-20-00269</b>	Double Tight Ferrule, PEEK

## Parker-Style 10-32 Fittings for 1/16" OD Tubing

<b>40-24-01275</b>	Nut, SS
<b>40-24-01276</b>	Nuts & Ferrules, SS, 10/Pk
<b>40-24-01291</b>	Ferrule, SS
<b>40-24-01290</b>	Ferrule, PEEK
<b>40-24-01271</b>	Union with Nuts & Ferrules, SS, .010" Thru
<b>40-24-01273</b>	Union with Nuts & Ferrules, SS, .020" Thru

## Genuine Valco 10-32 Fittings for 1/16" OD Tubing

<b>41-24-01277</b>	Nut, SS
<b>41-24-01281</b>	Nuts & Ferrules, SS, 10/Pk
<b>41-24-01278</b>	Nut, Long, SS
<b>41-24-01279</b>	Ferrule, SS
<b>41-24-01283</b>	Union with Nuts & Ferrules, SS, .010" Thru
<b>41-24-01280</b>	Union with Nuts & Ferrules, SS, .030" Thru
<b>41-24-01282</b>	Ferrule, PEEK

## Waters-Style 10-32 Fittings for 1/16" OD Tubing

		OEM #
<b>39-24-01090</b>	Compression Screw, SS	<b>WAT005070</b>
<b>39-24-01091</b>	Compression Screws & Ferrules, SS, 10/Pk	<b>WAT025604</b>
<b>39-24-01291</b>	Ferrule, SS, Single	<b>WAT005063</b>
<b>39-24-01290</b>	Ferrule, PEEK	<b>WAT021817</b>
<b>39-24-01088</b>	Union with Nuts & Ferrules, SS	<b>WAT097332</b>

# OPTI-LOK™ ADAPTERS

OPTI-LOK Adapters offer maximum flexibility for making connections between mating ports and 1/4-28, M6 (Metric), Luer and 10-32 fittings. Adapters are available in a useful variety of thread-type combinations. All are precision machined from PEEK.

## 1/4-28 to 10-32

**10-23-00350** 1/4-28 Male  10-32 Parker Female

## 1/4-28 to Luer

**10-23-00352** 1/4-28 Male  Luer Male

**10-23-00353** 1/4-28 Male  Luer Female

## 1/4-28 to M6

**10-23-00351** 1/4-28 Male  M6 (Metric) Female

## 1/4-28 to Luer

**10-23-00347** 1/4-28 Female  Luer Male

**10-23-00349** 1/4-28 Female  Luer Female

## 1/4-28 to M6

**10-23-00346** 1/4-28 Female  M6 Female, with Web

**10-23-00335** 1/4-28 Female  10-32 Parker Female

## M6 to 10-32

**10-23-00357** M6 (Metric) Male  10-32 Parker Female

**10-23-00355** M6 (Metric) Female  10-32 Parker Female

## M6 to Luer

**10-23-00363** M6 (Metric) Female  Luer Female

## Luer to 10-32

**10-23-00358** 10-32 Parker Female  Luer Female

**10-23-00359** 10-32 Parker Female  Luer Male

## ORIGINAL EXP® FITTING SYSTEM - SS TUBING

The EXP Fitting System is the premier adjustable nut and ferrule compression fitting for extreme high-pressure connections between 1/32" or 1/16" tubing and any 6-32, 6-40 or 10-32 port. EXP Fittings are simple and versatile.

The patented Titanium Hybrid Ferrule integrates the resilience of titanium with the proven sealing ability of PEEK in a superb one-piece design. The Hybrid Ferrule provides a perfect seal with every connection. The swage can be released without tools to adjust to the different port depths of various hardware. This adjustability provides value through repeated zero-dead-volume connections with any port configuration.

## EXP®2 FITTING SYSTEM - SS TUBING

Optimize introduces EXP2 - the next generation of EXP UHPLC fitting technology. Featuring a small 3/16" hex head EXP2 Nut, the new EXP2 Driver and the original Titanium Hybrid Ferrule, the EXP2 Fittings offer hand-tight connections rated to 20,000+ psi. The EXP2 nuts are available with 6-32, 6-40 and 10-32 threads and are scaled down to allow for maximum working room in cramped spaces. The EXP2 Driver is a small, easy to use knurled torque driver which snaps onto the nuts for hand-tightening and loosening. The EXP2 Driver is slotted and can be removed from the nut and tubing after use.

Both the EXP and EXP2 Fitting Systems offer products which can be reused in different ports for the best possible connections. These products eliminate the need to cut off and replace swaged ferrules.

### EXP® Titanium Hybrid Replacement Ferrules

SINGLES	10 PACK	
15-24-03831	15-24-03832	1/16" Ferrule
15-19-04242	15-19-04243	1/32" Nano Ferrule

### Original EXP® Hand-Tight Fittings with Titanium Hybrid Ferrules

SINGLES	10 PACK	
15-20-03888	15-20-03930	10-32 Nut & 1/16" Ferrule
15-19-04245	15-19-04246	6-40 Nut & 1/32" Nano Ferrule

### Original EXP® Hand-Tight Coupler

15-20-04128	1/16" OD x 0.005" ID x 5cm Stainless Steel Tubing Includes 2 Original EXP Hand-Tight Fittings
-------------	--

### EXP® Hex Head Fittings with Titanium Hybrid Ferrules

SINGLES	10 PACK	
15-20-04120	15-20-03834	10-32 Standard Nut & 1/16" Ferrule
15-20-03839	15-20-03840	10-32 Short Nut & 1/16" Ferrule
15-20-03841	15-20-03842	10-32 Long Nut & 1/16" Ferrule

## HAND-TIGHT



### Original **EXP**® Hand-Tight

Hand-Tight to 8,700+ psi  
Wrench-Tight to 20,000+ psi



### **EXP**®2 Hand-Tight

Hand-Tight or Wrench-Tight to 20,000+ psi

### **EXP**® Fitting Advantages

- Available in standard (1/16") and nano (1/32") configurations
- Rated to 20,000+ psi (1,400+ bar)
- Tested to 30,000 psi
- Auto-adjusting zero-dead-volume connection
- Intended for many repeat uses
- Cost efficient with replaceable components

## HEX HEAD

Wrench-Tight to 20,000+ psi



### **EXP**®2 Hand-Tight Fitting Kits with Titanium Hybrid Ferrules

Each pack below includes 1 EXP2 Driver

SINGLES	10 PACK	
<b>15-20-04933</b>	<b>15-20-04924</b>	10-32 EXP2 Nut & 1/16" Ferrule
<b>15-19-04961</b>	<b>15-19-04962</b>	6-40 EXP2 Nut & 1/32" Nano Ferrule
<b>15-19-04958</b>	<b>15-19-04959</b>	6-32 EXP2 Nut & 1/32" Nano Ferrule

FINALLY, A REUSABLE  
UHPLC FITTING THAT WORKS  
WITH ALL TUBING MATERIALS.  
HASSLE FREE, NO SEPARATE  
FERRULE TO LOSE.

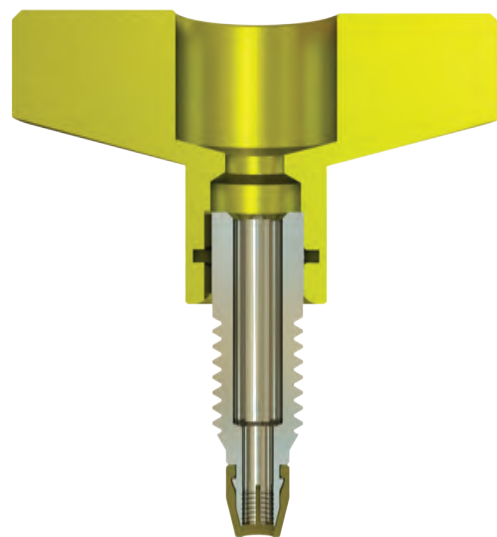

## EXP<sup>®</sup>2 TI-LOK<sup>™</sup> FITTINGS



### EXP<sup>®</sup>2 TI-LOK<sup>™</sup> FITTING

The EXP2 TI-LOK Fittings offer LC connections that can be hand-tightened to 18,000+ psi (1,250+ bar). The fittings are ideal for making HPLC and UHPLC connections that easily fit into tight spaces such as injection valves, column couplers, sample loops and column ovens.

Evolving from the original Titanium Hybrid Ferrule technology, EXP2 TI-LOK Fittings feature built-in PEEK ferrules and threaded nuts precision machined from titanium. The new fittings combine the superior corrosion resistance and robustness of titanium with the sealing capability of PEEK. Utilizing a unique geometric design, the fittings firmly press tubing against the tube stop of any instrument port creating a zero-dead-volume (ZDV) connection. The ferrule does not permanently swage to the tubing, allowing for many repeat connections and the ability to adjust the tubing to different port depths. EXP2 TI-LOK Fittings are compatible with PEEK, PEEKsil, Hastelloy C and stainless steel tubing.

EXP2 TI-LOK Fittings include an EXP2 Driver - a small, easy to use knurled torque driver that snaps onto the nuts for hand-tightening and loosening. The EXP2 Driver is slotted and can be removed from the nut and tubing after use.

### EXP<sup>®</sup>2 TI-LOK<sup>™</sup> ALL-IN-ONE (AIO) FITTING

Meet the newest addition to our EXP2 Fitting line. The AIO Fitting incorporates all of the features above with one distinct difference: a permanently-fixed driver. When tight spaces are not an issue, we recommend using the AIO Fitting.

## HAND-TIGHT

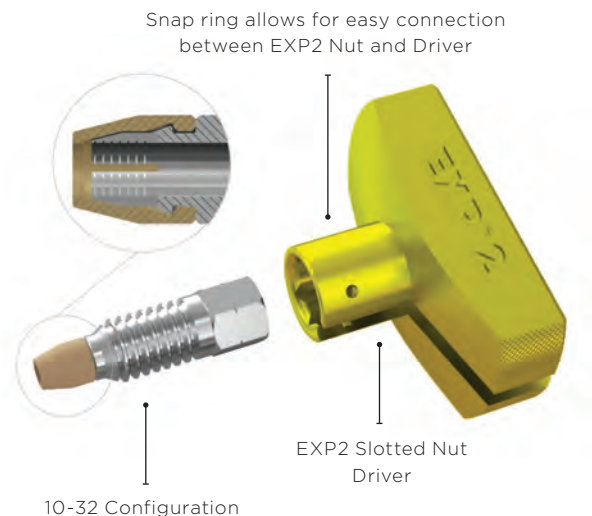

### New **EXP<sup>2</sup>** TI-LOK™

Hand-Tight to 8,700+ psi  
Wrench-Tight to 18,000+ psi



### New **EXP<sup>2</sup>** TI-LOK™ AIO

Hand-Tight to 8,700+ psi  
Wrench-Tight to 18,000+ psi

#### **EXP<sup>2</sup>** TI-LOK™ Hand-Tight Fittings

**15-24-05204** 10-32 TI-LOK Fitting, 2/Pk

**15-24-05205** 10-32 TI-LOK Fitting, 10/Pk

Each pack above includes 1 EXP2 Driver

#### **EXP<sup>2</sup>** TI-LOK™ All-In-One (AIO) Hand-Tight Fittings

**15-24-05253** 10-32 AIO Fitting, 1/Pk

**15-24-05254** 10-32 AIO Fittings, 10/Pk

#### KEY FEATURES

- Rated to 18,000+ psi (1,250+ bar)
- Titanium nut with integral PEEK ferrule
- One-piece fitting (no loose ferrules)
- Robust design with superior corrosion resistance
- Auto-adjusting zero-dead-volume connection
- Intended for many repeat uses
- Releases tubing for easy repositioning into different ports
- No need to cut tubing to replace a swaged ferrule
- Simple and versatile - can be used in all LC applications
- Compatible with PEEK, PEEKsil, Hastelloy C and stainless steel tubing

# EXP<sup>®</sup>2 TI-LOK™ FITTINGS AND ADAPTERS

## FOR ALL 1/32" TUBING AND 360µm OD FUSED SILICA TUBING

The EXP2 TI-LOK Fittings and Adapters offer capillary HPLC and UHPLC connections that seal to 20,000+ psi in any port and easily fit into tight spaces such as injection valves, column couplers, sample loops and column ovens.

The EXP2 TI-LOK range of fittings and adapters allows users the versatility to change out capillary tube ID, length or end fittings to create virtually any tube set configuration. The EXP2 TI-LOK Fittings are available with 6-32 and 6-40 threads for 1/32" ports. The EXP2 TI-LOK Adapters will allow users to connect 1/32" OD tubing directly to a standard 10-32 port designed for 1/16" tubing.

The EXP2 TI-LOK Fittings and Adapters combine the robustness of titanium and the sealing capability of PEEK. Utilizing a unique patented inverted geometric design, the fittings and adapters firmly compress the PEEK sleeve of the PEEKsil or fused silica tubing against the tube stop of any instrument port creating a zero-dead-volume (ZDV) connection without fracturing the fused silica. The titanium portion of the fitting does not permanently swage to the tubing, allowing for many repeat connections and the ability to adjust the tubing to different port depths.

Using the EXP2 Driver, the EXP2 TI-LOK Fittings and Adapters can be hand-tightened into any HPLC or UHPLC port. The EXP2 Driver is a small, easy to use knurled torque driver which snaps onto the fitting hex for hand-tightening and loosening. The EXP2 Driver is slotted and can be removed from the fitting and tubing after each installation. The EXP2 TI-LOK Fittings and Adapters are available as kits which include the EXP2 Driver. For use with 360µm fused silica; 10-32 Adapters have an integral sleeve. Simply cut fused silica to desired length, insert into adapter and tighten into port. To use 6-32 and 6-40 fittings with fused silica tubing, the purchase of 1/32" OD PEEK sleeves is required.

Additionally, the EXP2 TI-LOK 10-32 Adapters can be purchased with a 0.5µm frit embedded in the tip to create an integral filter or capillary column end-fitting in standard 1/16" tubing ports.

### EXP<sup>®</sup>2 TI-LOK™ Hand-Tight Fittings

Each pack below includes 1 EXP2 Driver

2 PACK	10 PACK	
15-19-05281	15-19-05282	6-40 TI-LOK Fitting
15-19-05285	15-19-05286	6-32 TI-LOK Fitting
10-13-05320	10-13-05321	1/32" OPTI-PEEK Sleeves for Fused Silica Tubing

### EXP<sup>®</sup>2 TI-LOK™ Hand-Tight Adapters (Adapts 1/32" Tubing and 360µm OD Fused Silica Tubing to 10-32 Ports)

Each pack below includes 1 EXP2 Driver

2 PACK	10 PACK	
15-24-05290	15-24-05291	10-32 Standard Parker-Style Adapter
15-24-05294	15-24-05295	10-32 Standard Parker-Style Adapter, with 0.5µm Frit
15-24-05327	15-24-05328	10-32 Standard Parker-Style Adapter for 360µm OD Fused Silica Tubing with Integral PEEK Sleeve
15-24-05298	15-24-05299	10-32 Waters-Style Port Adapter
15-24-05302	15-24-05303	10-32 Waters-Style Port Adapter, with 0.5µm Frit
15-24-05331	15-24-05332	10-32 Waters-Style Port Adapter for 360µm OD Fused Silica Tubing with Integral PEEK Sleeve



## HAND-TIGHT

### EXP<sup>®</sup>2 TI-LOK™ 6-40 Hand-Tight Fitting

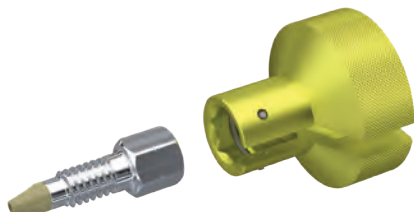

### EXP<sup>®</sup>2 TI-LOK™ Hand-Tight Adapter

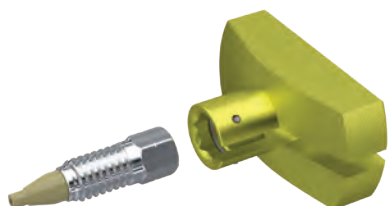

### Advantages of EXP<sup>®</sup>2 Fittings and Adapters

- Rated hand-tight to 20,000+ psi (1,400+ bar)
- Auto-adjusting zero-dead-volume connection
- Extremely robust one-piece ferrule design
- Intended for many repeat uses
- Cost efficient with replaceable components
- Perfect for standard or nano UHPLC and UHPLC/MS

### CROSS SECTIONS OF EXP2 10-32 ADAPTERS

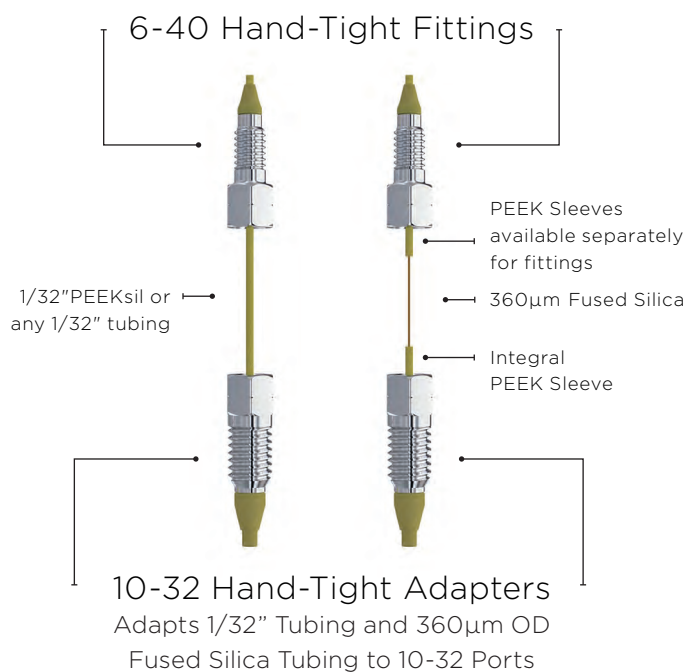

Before purchasing 10-32 Adapters, please verify your port type.

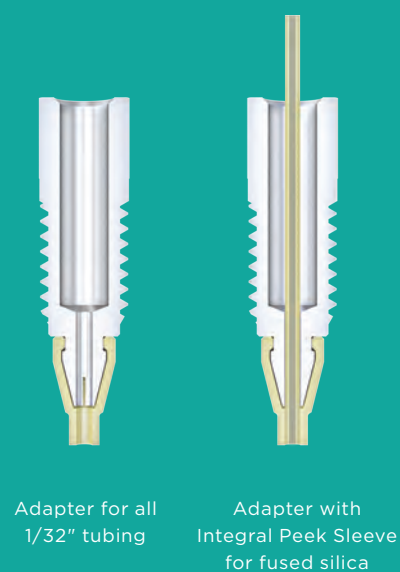





# DIY EXP<sup>®</sup>2 TI-LOK™ FITTING & ADAPTER KITS

## MAKE YOUR OWN HAND-TIGHT UHPLC CONFIGURATIONS

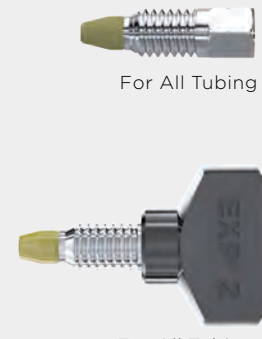
Any pressure. Any tubing. Any length. Any port. Any combination.

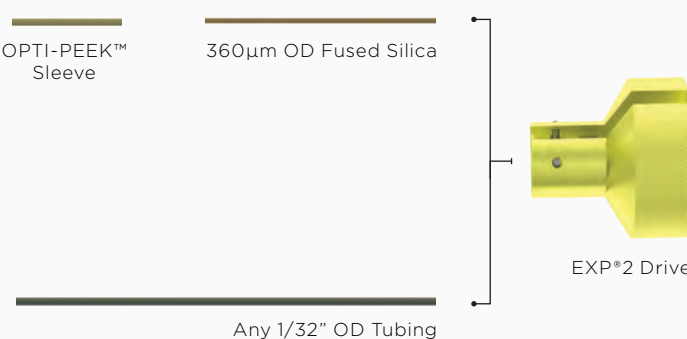
The possibilities are endless...

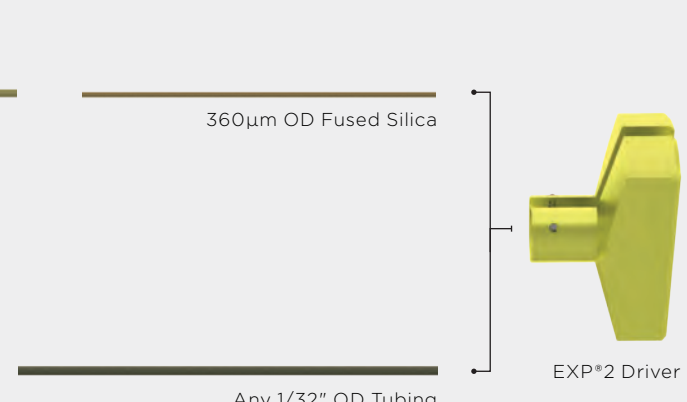
<p><b>EXP<sup>®</sup>2 TI-LOK™</b> 10-32 FITTINGS (Pg. 15-16)</p>	 <p>For All Tubing</p> <p>For All Tubing</p>	 <p>Any 1/16" OD Tubing</p> <p>EXP<sup>®</sup>2 Driver</p> <p>Any 1/16" OD Tubing</p>
<p><b>EXP<sup>®</sup>2 TI-LOK™</b> 6-32 &amp; 6-40 FITTINGS (Pg. 17-18)</p>	 <p>For Fused Silica Tubing</p> <p>For All Tubing</p>	 <p>OPTI-PEEK™ Sleeve</p> <p>360µm OD Fused Silica</p> <p>Any 1/32" OD Tubing</p> <p>EXP<sup>®</sup>2 Driver</p>
<p><b>EXP<sup>®</sup>2 TI-LOK™</b> 10-32 ADAPTERS (Pg. 17-18)</p>	 <p>For Fused Silica Tubing</p> <p>For All Tubing</p>	 <p>360µm OD Fused Silica</p> <p>Any 1/32" OD Tubing</p> <p>EXP<sup>®</sup>2 Driver</p>

For more applications such as sample loops and packed capillary columns, please contact Optimize for more information.

# TUBING

## OPTI-PEEK™ TUBING SLEEVES

### 1/32" Outside Diameter PEEK Tubing

<b>10-13-05320</b>	1/32" OD x .015" ID x 1" LG, 2PK
<b>10-13-05321</b>	1/32" OD x .015" ID x 1" LG, 10PK

## OPTI-PEEK™ TUBING

### 1/16" Outside Diameter PEEK Tubing

<b>10-13-00168</b>	1/16" OD x .006" ID x 10 ft
<b>10-13-00170</b>	1/16" OD x .006" ID x 50 ft
<b>10-13-00175</b>	1/16" OD x .010" ID x 10 ft
<b>10-13-00177</b>	1/16" OD x .010" ID x 50 ft
<b>10-13-00183</b>	1/16" OD x .020" ID x 10 ft
<b>10-13-00186</b>	1/16" OD x .020" ID x 50 ft
<b>10-13-00187</b>	1/16" OD x .030" ID x 10 ft
<b>10-13-00191</b>	1/16" OD x .030" ID x 50 ft
<b>10-13-00179</b>	1/16" OD x .040" ID x 10 ft
<b>10-13-00181</b>	1/16" OD x .040" ID x 50 ft

## STAINLESS STEEL PRE-CUT TUBING

### 1/16" Outside Diameter Stainless Steel Tubing

<b>10-12-00145</b>	1/16" OD x .006" ID x 6 cm
<b>10-12-00143</b>	1/16" OD x .006" ID x 10 cm
<b>10-12-00144</b>	1/16" OD x .006" ID x 20 cm
<b>10-12-00141</b>	1/16" OD x .006" ID x 10 ft
<b>10-12-00151</b>	1/16" OD x .010" ID x 6 cm
<b>10-12-00148</b>	1/16" OD x .010" ID x 10 cm
<b>10-12-00149</b>	1/16" OD x .010" ID x 20 cm
<b>10-12-00150</b>	1/16" OD x .010" ID x 30 cm
<b>10-12-00146</b>	1/16" OD x .010" ID x 10 ft
<b>10-12-00154</b>	1/16" OD x .020" ID x 10 cm
<b>10-12-00155</b>	1/16" OD x .020" ID x 20 cm
<b>10-12-00156</b>	1/16" OD x .020" ID x 30 cm
<b>10-12-00152</b>	1/16" OD x .020" ID x 10 ft
<b>10-12-00162</b>	1/16" OD x .030" ID x 6 cm
<b>10-12-00160</b>	1/16" OD x .030" ID x 10 cm
<b>10-12-00161</b>	1/16" OD x .030" ID x 20 cm
<b>10-12-00158</b>	1/16" OD x .030" ID x 10 ft
<b>10-12-00165</b>	1/16" OD x .040" ID x 10 cm
<b>10-12-00166</b>	1/16" OD x .040" ID x 20 cm
<b>10-12-00163</b>	1/16" OD x .040" ID x 10 ft

Optimize stainless steel tubing is pre-cut and electropolished to ensure square, burr-free ends and is passivated prior to shipment.

## PTFE TUBING

### 1/16" Outside Diameter PTFE Tubing

<b>10-15-00214</b>	1/16" OD x .010" ID x 10 ft
<b>10-15-00220</b>	1/16" OD x .020" ID x 10 ft
<b>10-15-00221</b>	1/16" OD x .020" ID x 50 ft
<b>10-15-00226</b>	1/16" OD x .030" ID x 10 ft
<b>10-15-00227</b>	1/16" OD x .030" ID x 50 ft
<b>10-15-00232</b>	1/16" OD x .040" ID x 10 ft
<b>10-15-00233</b>	1/16" OD x .040" ID x 50 ft

### .100" Outside Diameter PTFE Tubing

<b>10-15-00205</b>	.100" OD x .040" ID x 10 ft
<b>10-15-00206</b>	.100" OD x .040" ID x 50 ft

### 1/8" Outside Diameter PTFE Tubing

<b>10-15-00238</b>	1/8" OD x .062" ID x 10 ft
<b>10-15-00240</b>	1/8" OD x .062" ID x 50 ft

### 3/16" Outside Diameter PTFE Tubing

<b>10-15-00243</b>	3/16" OD x .125" ID x 10 ft
<b>10-15-00245</b>	3/16" OD x .125" ID x 50 ft

## ETFE TUBING

### 1/16" Outside Diameter ETFE Tubing

<b>10-14-00193</b>	1/16" OD x .010" ID x 10 ft
<b>10-14-00194</b>	1/16" OD x .010" ID x 50 ft
<b>10-14-00196</b>	1/16" OD x .020" ID x 10 ft
<b>10-14-00197</b>	1/16" OD x .020" ID x 50 ft
<b>10-14-00199</b>	1/16" OD x .030" ID x 10 ft
<b>10-14-00200</b>	1/16" OD x .030" ID x 50 ft

# TUBING CUTTERS

<b>10-10-00139</b>	Plastic Tubing Cutter
<b>10-10-00140</b>	Stainless Steel Tubing Cutter



Plastic Tubing Cutter

Stainless Steel Tubing Cutter

## FILTRATION

Keeping particulates out of the flow path prevents premature wear on vital components, drastically reducing the need for costly replacements or repairs. A holistic approach to filtration addresses potential particulates throughout the solvent flow path and leads to consistent and efficient chromatography. Generally, there are three critical areas where filtration is necessary.

### Solvent Reservoir

While the availability of HPLC-grade solvents diminishes the need for pre-filtering, it is imperative that a filtration device be installed in the reservoir. Placing a filter in the reservoir is an economical way to filter particles that may result from buffer salt precipitation, airborne dust, improperly cleaned glassware, or microbial contamination; none of which are remedied by the use of HPLC-grade solvents.

### In-line

The frictional forces generated at the piston/seal interface inevitably lead to particulate shedding. Placement of a filtering element between the pump and injector/autosampler removes the particulates, preventing problems with downstream components and costly downtime.

### Pre-Column / Direct Connect

Many things contribute to particulates in the post-injector region: incompatibilities between sample matrix and mobile phase, septa coring from the sample needle and shedding from moving parts in the injector, etc. Use of a low-impact, pre-column filter removes these particulates from the flow path, saving your analytical column and detector from deleterious effects.

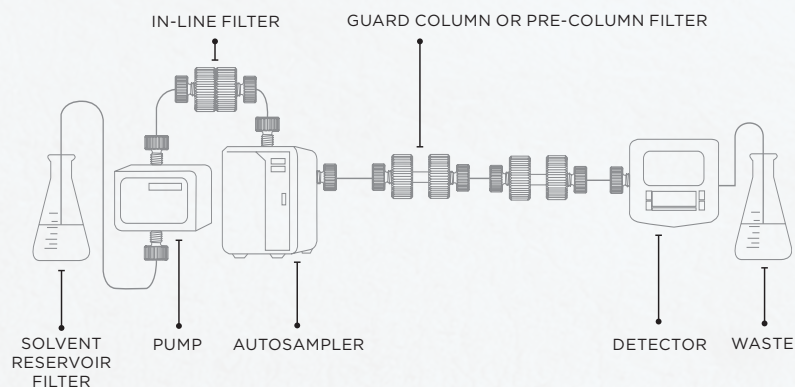



## GUIDE TO OPTIMIZE FILTERS

	OPTI-SOLV <sup>®</sup>	OPTI-SOLV <sup>®</sup>	OPTI-SOLV <sup>®</sup>	OPTI-SOLV <sup>®</sup>	OPTI-SOLV <sup>®</sup>	OPTI-LYNX™2	EXP <sup>®</sup> 2	EXP <sup>®</sup> 2
	Solvent Reservoir Filters	In-Line Filters	Mini Filter	Micro Filter	Nano Filter	Filter	Stem Filter	Pre-Column & In-Line Filter
	Pg. 23	Pg. 24	Pg. 25	Pg. 26	Pg. 26	*see below	Pg. 27	Pg. 28
Maximum Pressure	N/A	 <b>HIGH PRESSURE</b> 6K PSI / 400 BAR	 <b>HIGH PRESSURE</b> 6K PSI / 400 BAR	 <b>HIGH PRESSURE</b> 6K PSI / 400 BAR	 <b>HIGH PRESSURE</b> 6K PSI / 400 BAR	 <b>HIGH PRESSURE</b> 6K PSI / 400 BAR	 <b>ULTRA HIGH PRESSURE</b> 20K+ PSI / 1400+ BAR	 <b>ULTRA HIGH PRESSURE</b> 20K+ PSI / 1400+ BAR
Porosities Available	2µm 10µm	.2µm .5µm 2µm	.5µm 2µm 5µm	.5µm 1µm 2µm 10µm	.5µm	*	.2µm .5µm	.2µm .5µm 2µm
Depth Filter			✓			✓		✓
Swept (Internal) Volume	N/A	<6µL	1.4µL	<200nL	50nL	1.4µL	.27µL	1.4µL
Configurations	Solvent Reservoir	In-Line	Direct-Connect / Pre-Column	Direct-Connect / Pre-Column	Direct-Connect / Pre-Column	In-Line & Pre-Column	Direct-Connect / Pre-Column	In-Line & Pre-Column
Auto Adjusting (ZDV) Port Connection	N/A	N/A	✓ Floating	✓ Floating	✓ Floating	✓ Spring-loaded	✓ Floating	✓ Spring-loaded
Holder or All-In-One (AIO) Disposable	AIO	Holder	AIO	AIO	AIO	Holder	Holder	Holder
Holder Fittings Included		✓				✓	✓	✓
Hand-Tight Holder & Cartridge Change	✓	✓	✓	✓	✓	✓	✓	✓

\* Please contact Optimize for pressure rating and further product details.

# OPTI-SOLV® SOLVENT RESERVOIR FILTERS

OPTI-SOLV Reservoir Filters have a unique conical design inside the filter housing to prevent air bubbles from getting trapped and disturbing your analysis.

A solid PTFE body keeps the OPTI-SOLV Reservoir Filter in the base of the bottle where a bottom-mounted titanium frit provides unrestricted solvent access. The Optimize design makes installation as simple as possible – no tools or fittings required.



### Biocompatible OPTI-SOLV® Analytical Reservoir Filters

SINGLES		5 PACK	
10-04-00079	10-04-00080	2µm	1/16" OD Tubing
10-04-00081	10-04-00082	10µm	
<hr/>			
10-04-00047	10-04-00050	2µm	1/8" OD Tubing
10-04-00051	10-04-00053	10µm	

### Reservoir Filters with Tube Stem

SINGLES		5 PACK	
10-04-00071	10-04-00072	2µm	1/16" ID Tubing
10-04-00073	10-04-00074	10µm	
<hr/>			
10-04-00115	10-04-00119	2µm	1/8" ID Tubing
10-04-00111	10-04-00114	10µm	

### Reservoir Filter with Tube Stem

4 PACK			
10-04-03151	10µm	1/8" ID Tubing	OEM# WAT025531

Reservoir Filters with tube stems are made with Hastelloy C® for maximum corrosion resistance and inertness.

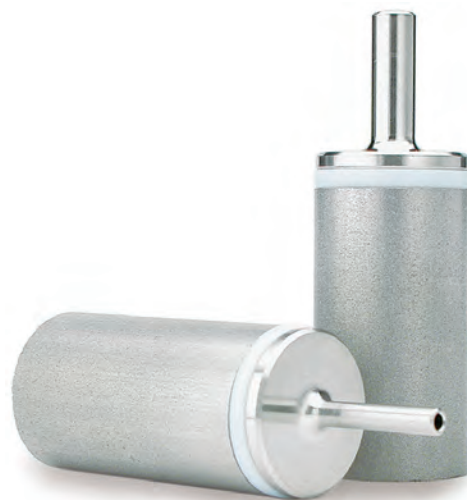

# OPTI-SOLV® IN-LINE FILTERS



Installed between the pump and injector/autosampler, the OPTI-SOLV In-Line Filter prevents damage to downstream components avoiding both instrument downtime and labor.

Simply hand-tighten the PEEK holder to make a high-pressure seal. For those who prefer wrenches, a wrench-tight stainless steel version is available. The user-friendly designs are well suited for a number of applications such as high temperature environments where quick changes are imperative.



PEEK "GORILLA GRIP" HAND-TIGHT HOLDER



STAINLESS STEEL (SS) WRENCH-TIGHT HOLDER



FILTER ELEMENT

## OPTI-SOLV® In-Line Filter Kits

Kits below include holder, fittings and 2 filter elements

10-04-02372	0.2µm, In-Line PEEK Hand-Tight Holder
10-04-02371	0.2µm, In-Line (SS) Wrench-Tight Holder
10-04-00386	0.5µm, In-Line PEEK Hand-Tight Holder
10-04-00383	0.5µm, In-Line (SS) Wrench-Tight Holder
10-04-00391	2µm, In-Line PEEK Hand-Tight Holder
10-04-00390	2µm, In-Line (SS) Wrench-Tight Holder

## OPTI-SOLV® In-Line Filter Holders

10-04-03685	In-Line PEEK Hand-Tight Holder
10-04-03686	In-Line (SS) Wrench-Tight Holder

## OPTI-SOLV® Filter Elements (Frits)

10-04-02370	0.2µm, 0.187" Dia. Filter, 10/Pk
10-04-03699	0.5µm, 0.062" Dia. Filter, 10/Pk
10-04-03701	0.5µm, 0.125" Dia. Filter, 10/Pk
10-04-00100	0.5µm, 0.187" Dia. Filter, 10/Pk
10-04-03700	2µm, 0.062" Dia. Filter, 10/Pk
10-04-03702	2µm, 0.125" Dia. Filter, 10/Pk
10-04-00103	2µm, 0.187" Dia. Filter, 10/Pk

"We have been using OPTI-SOLV In-Line Filters for several years in our high-throughput LC/MS Analysis of ADME screening samples."

Partner: Pfizer ADME Technology Group

## Two-Piece PEEK or Stainless Steel Holders

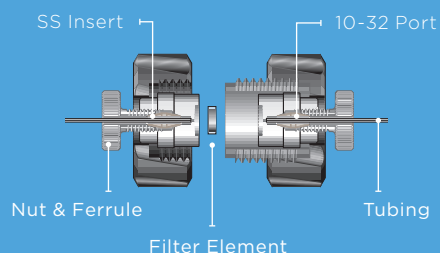

The OPTI-SOLV's unique swivel design allows frits to be changed without removing the connecting tubing. Just plumb the holder once and leave it.

# OPTI-SOLV<sup>®</sup> MINI FILTER

The OPTI-SOLV Mini Filter provides low-impact filtration in a package no larger than a finger-tight fitting. Use the Mini Filter to extend the life of analytical columns or before mass spectrometers as a last line of defense against debris.

Perfect zero-dead-volume connections are obtained every time with the patented automatic tube stop depth adjustment. Unique depth-filtering elements allow for greater capacity with no band spreading or loss of performance. The efficient design requires no holder and threads directly into any 10-32 port.

## THE OPTI-SOLV<sup>®</sup> MINI, MICRO & NANO FILTERS AUTOMATICALLY ADJUST TO FIT ALL BRANDS OF COLUMNS.

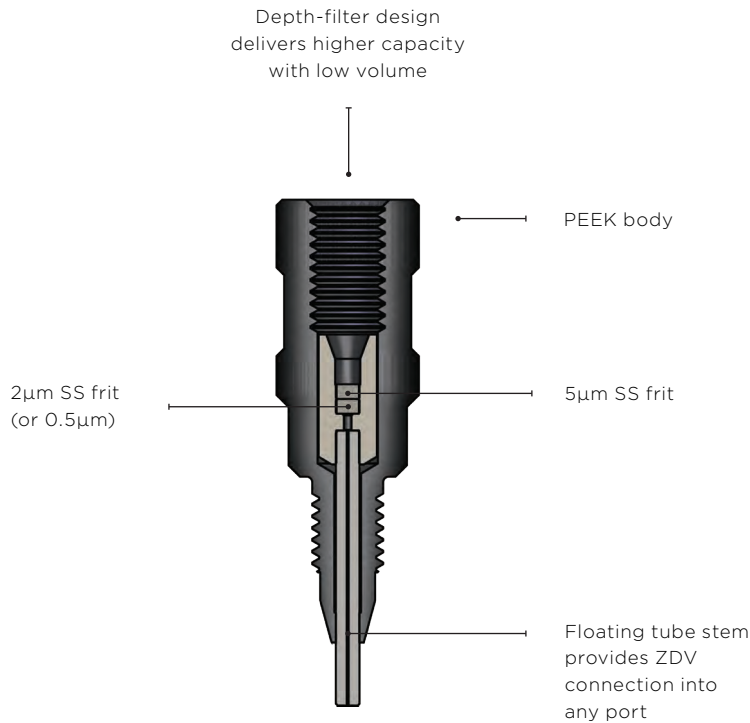

### OPTI-SOLV<sup>®</sup> Mini Filters

<b>10-04-00095</b>	OPTI-SOLV Mini Filter, 0.5 $\mu$ m, 5/Pk
<b>10-04-00097</b>	OPTI-SOLV Mini Filter, 2.0 $\mu$ m, 5/Pk
<b>10-04-02768</b>	OPTI-SOLV Mini Filter, 5.0 $\mu$ m, 5/Pk



# OPTI-SOLV® MICRO FILTER



For volume critical filtering needs, Optimize offers the OPTI-SOLV Micro Filter. Based on the design that made the Mini Filter successful, the Micro Filter cuts the internal volume to less than 200nL while retaining the ease of use and functionality of the Mini Filter.

The Micro Filter is designed to be used in today's low volume, high sensitivity chromatographic applications as a last line of defense against debris. As with all Optimize column protection products, the OPTI-SOLV Micro Filter features a zero-dead-volume connection utilizing patented floating stem (auto-adjusting) technology.

## OPTI-SOLV® Micro Filters

<b>10-04-03621</b>	OPTI-SOLV Micro Filter, 0.5µm, 5/Pk
<b>10-04-03357</b>	OPTI-SOLV Micro Filter, 1.0µm, 5/Pk
<b>10-04-03389</b>	OPTI-SOLV Micro Filter, 2.0µm, 5/Pk
<b>10-04-03707</b>	OPTI-SOLV Micro Filter, 10µm, 5/Pk

## OPTI-SOLV® Biocompatible Micro Filters

<b>10-04-03936</b>	OPTI-SOLV Biocompatible Micro Filter, 0.5µm, 5/Pk Wetted materials: PEEK and titanium
--------------------	--

# OPTI-SOLV® NANO FILTER

The OPTI-SOLV Nano Filter cuts the internal volume down even further. With less than 50nL of internal volume, the OPTI-SOLV Nano Filter is ideal for mass spectrometry to protect electrospray and nanospray tips from clogging with debris.

## OPTI-SOLV® Nano Filter

<b>10-04-03625</b>	OPTI-SOLV Nano Filter, 0.5µm, 5/Pk
--------------------	------------------------------------

## OPTI-SOLV® Biocompatible Nano Filter

<b>10-04-03939</b>	OPTI-SOLV Biocompatible Nano Filter, 0.5µm, 5/Pk Wetted materials: PEEK and titanium
--------------------	---

The OPTI-SOLV® Mini, Micro and Nano filters are easy to use and perform exceptionally well for volume-critical applications.

Advantages of the OPTI-SOLV® Mini, Micro and Nano Filters:

- Designed to filter out particles to extend column life
- Perfect Zero-Dead-Volume connections every time
- Floating stem automatically adjusts to any depth port
- Hand-tight - no tools required
- Rated to 6,000 psi



Modern UHPLC and UHPLC/MS instrumentation pushes the envelope in fluid handling with tiny passages and extremely high pressures. At any time, an unprotected system is a stray 1 $\mu$ m seal fragment away from failure, loss of data continuity and subsequent troubleshooting and repair. The best assurance against this costly prospect comes from safeguarding your system with thorough filtration.

The EXP2 Stem Filter features a choice of frit porosities integrated with our patented auto-adjusting stem for repeated ZDV connections with any 10-32 port. The entire filter stem and reusable holder are only slightly larger than a standard HPLC fitting. The slim architecture allows it to easily fit into crowded instrument compartments, tightly-spaced injection ports and anywhere else an extra level of protection against clogging and contamination is necessary. The EXP2 Stem Filter is an ideal solution to protect expensive UHPLC columns, injectors, autosamplers and MS electrospray tips without extra-column effects.

When tightened by hand, the EXP2 Stem Filter seals to 8,700+ psi. The reusable holder hardware also incorporates wrench flats to enable flawless sealing to 20,000+ psi (1,400+ bar). The EXP2 Stem Filter is the ultimate low-impact protection for expensive UHPLC and MS equipment, assuring trouble-free performance allowing the user to concentrate on the data, not troubleshooting.

### Advantages of the EXP<sup>®</sup>2 Stem Filter

- Approved for use at 20,000+ psi (1,400+ bar)
- Hand-tight and wrench-tight configuration
- Reusable holder intended for many repeat uses
- Auto-adjusting ZDV connections
- Low-dispersion cartridges
- Custom volumes/porosities available
- Ultra-low .27 $\mu$ L total swept volume
- New EXP2 design incorporates integral ferrule into the front-end of the holder. No separate ferrule to lose.

actual size

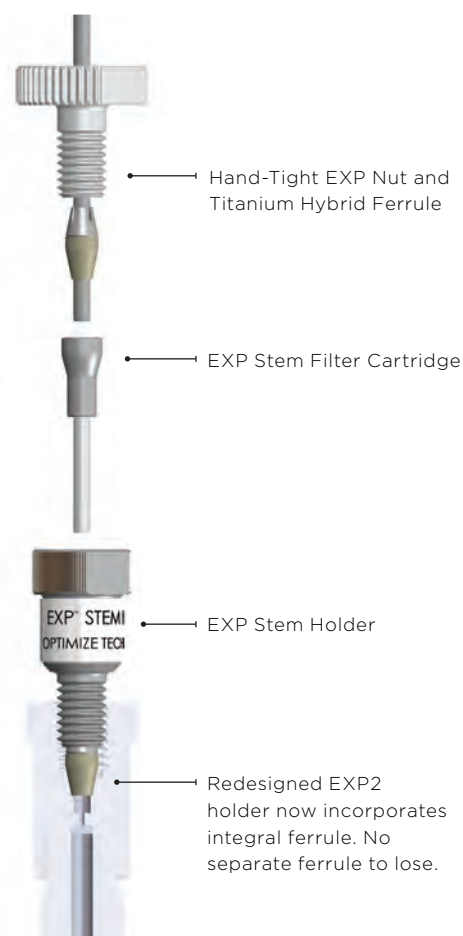

### EXP<sup>®</sup>2 Stem Filter Kit

Kits below include holder, 3 stem filter cartridges and fittings

**15-04-04122** 0.2 $\mu$ m, Filter Kit

**15-04-04123** 0.5 $\mu$ m, Filter Kit

### EXP<sup>®</sup>2 Stem Filter Cartridges

**15-04-04117** 0.2 $\mu$ m, Filter Cartridge, 5/Pk

**15-04-04119** 0.5 $\mu$ m, Filter Cartridge, 5/Pk

The EXP2 Pre-Column and In-Line Hand-Tight Filters are ideal for protecting small-particle UHPLC columns and systems at extreme pressures. Such techniques analyze samples in the most demanding applications, decreasing the life of expensive hardware. EXP2 Filters help extend the life of a UHPLC system and protect your investment without sacrificing performance. Free-Turn<sup>®</sup> architecture allows the user to change cartridges by hand without breaking fluid connections on the holder inlet/outlet.

EXP2 Pre-Column Filter holders are available with Titanium Hybrid Ferrules for easy direct connection to any 10-32 port. The filter holder is a complete package and includes fittings to provide repeated zero-dead-volume connections.

## Advantages of EXP<sup>®</sup>2 Filters

- Approved for use at 20,000+ psi (1,400+ bar)
- Hand-tight filter replacement - no tools needed
- Auto-adjusting ZDV connections
- Depth filtration maximizes capacity
- Low-volume, low-dispersion cartridges
- Hardened stainless steel end cap eliminates galling
- New design offers more cost efficient cartridges

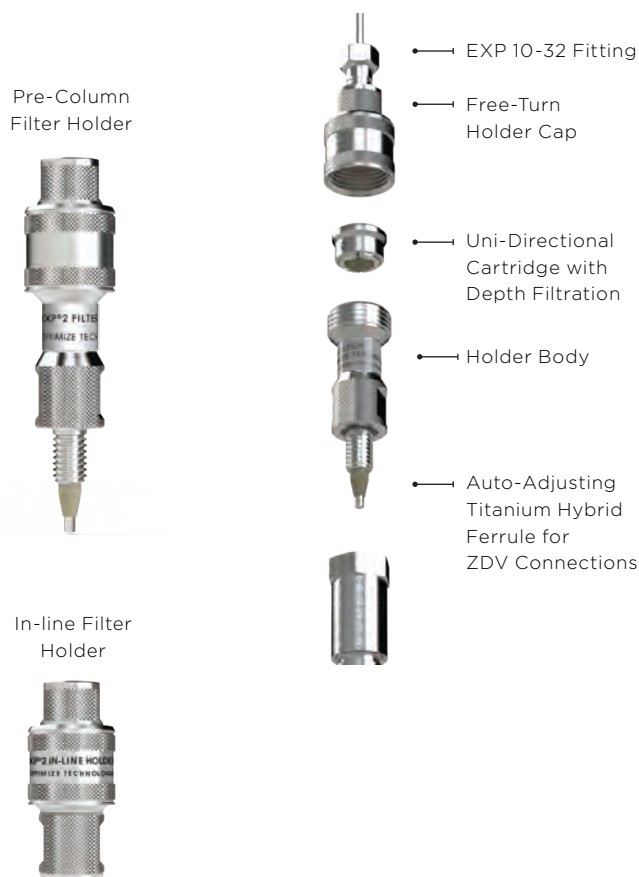

## EXP<sup>®</sup>2 Filter Holders

**15-04-05242** EXP2 Pre-Column Filter Holder

**15-04-05258** EXP2 In-Line Filter Holder

The above holders include fittings

## EXP<sup>®</sup>2 Filter Cartridges

5 PACK	10 PACK	
<b>15-04-05263</b>	<b>15-04-05264</b>	0.2µm, 3mm Cartridge
<b>15-04-05261</b>	<b>15-04-05262</b>	0.5µm, 3mm Cartridge
<b>15-04-05259</b>	<b>15-04-05260</b>	2µm, 3mm Cartridge

## EXP<sup>®</sup> Filter Cartridges (Old Style)

5 PACK	10 PACK	
<b>15-04-03096</b>	<b>15-04-03097</b>	0.2µm Cartridge
<b>15-04-03093</b>	<b>15-04-03094</b>	0.5µm Cartridge



## TRAP COLUMNS

Trapping is a chromatography technique that allows for the concentration or purification of a sample. A trap cartridge is a packed column bed loaded with a material to create desirable conditions for separating the target compound from the rest of the sample matrix. This is accomplished by selecting a packing material that has a strong affinity for the target compound causing the analyte to be retained in the trap while the rest of the sample matrix flows through; or by selecting a material which has no affinity for the target compound but that binds other unwanted matrix components such as salts, detergents and contaminants.

Trap columns are uni-directional or bi-directional and are used either on-line or off-line for sample pre-concentration and clean-up. Trap column bed materials need not be similar to the primary LC column bed materials and can be selected based on sample clean-up needs. Desirable characteristics of a trap include low back pressure, bi-directional flow, a robust bed, the ability to regenerate the packed bed and low swept volume.

To learn more about LC or LC/MS off-line and on-line trapping, please refer to the LC Trapping Guide on pages 75-87.

### TRAP CARTRIDGE SELECTION GUIDES

In an effort to consolidate part numbers, options and associated stationary phases, trap cartridge part numbers are condensed in tables on the following pages.

### HOW TO USE OUR SELECTION GUIDES

Find the five digits matching the required trap dimensions. Then, identify the two letter packing code for the phase.

**Example:** a single 5µL cartridge with SCX phase will be part number 10-04815-TP.

	Bed Volume	Dimensions	Dimension Code	Code	Phase
SINGLES	0.5µL	0.5 x 2mm	0 4 8 1 3	T P	SCX
	5µL	1 x 8mm	0 4 8 1 5	T Q	Small Molecule
	50µL	3 x 8mm	0 4 8 1 7	E S	Custom

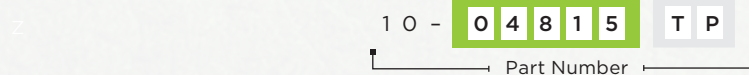



## GUIDE TO OPTIMIZE TRAP COLUMNS

	OPTI-TRAP™	OPTI-LYNX™	OPTI-LYNX™2	EXP*2	EXP*2	EXP*
	Column	Micro Trap	Trap	Nano Trap	Stem Trap	Trap Column
	pg. 31	pg. 32	*see below	pg. 33	pg. 35	pg. 37
Maximum Pressure	 <b>MEDIUM PRESSURE</b> 1.5K PSI / 100 BAR	 <b>HIGH PRESSURE</b> 6K PSI / 400 BAR	 <b>HIGH PRESSURE</b> *see below	 <b>ULTRA HIGH PRESSURE</b> 20K+ PSI / 1400+ bar	 <b>ULTRA HIGH PRESSURE</b> 20K+ PSI / 1400+ BAR	 <b>ULTRA HIGH PRESSURE</b> 20K+ PSI / 1400+ BAR
Bed Volumes Available	0.5µL 5µL 50µL	4µL 10µL 20µL 40µL	20µL 40µL 100µL	.12µL .30µL 1µL	.17µL .33µL .68µL 1.5µL 2.6µL	4µL 10µL 20µL 40µL 100µL >100µL / Custom
Custom Packing Available	✓	✓	✓	✓	✓	✓
Holder Configurations	In-Line & Manual (off-line)	In-Line & Direct-Connect	In-Line & Direct-Connect	In-Line & Direct-Connect	Direct-Connect	In-Line & Direct-Connect
Hand-Tight Holder Hand-Tight Cartridge Change	✓	✓	✓	✓	✓	✓
Holder Thread Type(s)	10-32	10-32	10-32	6-32 6-40 10-32	10-32	10-32
Holder Fittings Included	✓	✓	✓	✓	✓	✓
Auto Adjusting (ZDV) Port Connection	N/A	Spring-loaded	Spring-loaded	Spring-loaded	Floating	Spring-loaded
Biocompatible Option	✓	✓				

\* Please contact Optimize for pressure rating and further product details.

The OPTI-TRAP is a bi-directional trap cartridge system which is used individually or in a series for sample concentration and purification. The OPTI-TRAP system features a durable biocompatible trap holder assembly made of either PEEK (capillary configuration) or stainless steel with a PEEK flow path (micro and macro configurations). OPTI-TRAPs feature low back pressure and are loaded and eluted manually with a syringe or on-line when plumbed into the sample injection valve. OPTI-TRAPs include titanium frits for full biocompatibility.

### OPTI-TRAP™ Advantages

- Rated hand-tight for use up to 1,500 psi (100 bar)
- Low back pressure, for syringe loading/eluting or on-line trapping
- Transparent cartridge allows for visual inspection of bed
- Bi-directional cartridge for flushing and bed regeneration
- Color coded band for identification of packing material
- PEEK and titanium flow path for biocompatibility



#### Manual Holder Kit

Capillary (0.5µL): **10-02-04749**

Micro (5µL): **10-02-04745**

Macro (50µL): **10-02-04747**

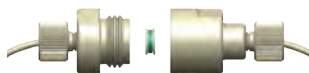

#### In-Line Capillary Holder Kit (0.5µL)

Includes fittings and tubing

**10-02-04808**

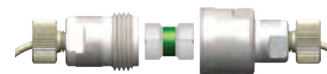

#### In-Line Micro / Macro Holder Kit (5 & 50µL)

Includes fittings and tubing

**10-02-04751**

### OPTI-TRAP™ CARTRIDGE SELECTION GUIDE

		Bed Volume	Dimensions	Load Rate (mL/min)	Dimension Code	Code	Phase	Band
SINGLES	Cap	0.5µL	0.5 x 2mm	0.005 - 0.020	0 4 8 1 3	T M	Protein	Black
	Micro	5µL	1 x 8mm	0.05 - 0.20	0 4 8 1 5	T N	Peptide	Green
	Macro	50µL	3 x 8mm	0.5 - 2	0 4 8 1 7	T O	NID	Blue
6 PACKS	Cap	0.5µL	0.5 x 2mm	0.005 - 0.020	0 4 8 1 4	T P	SCX	Orange
	Micro	5µL	1 x 8mm	0.05 - 0.20	0 4 8 1 6	T Q	Small Molecule	Purple
	Macro	50µL	3 x 8mm	0.5 - 2	0 4 8 1 8	E S	Custom	Gray

To calculate the approximate sample capacity of each trap cartridge, we recommend using the ratio 4µg/1µL of bed volume. For more information about how to use this table, please see page 29.



The new OPTI-LYNX Micro offers chromatographers a versatile selection of packed bed cartridges coupled with a convenient quick-connect holder. Many options are available for on-line and off-line sample pre-concentration and clean-up. Each cartridge shares the same external dimensions allowing different dimensions and porosities to be used in the same holder hardware. Two styles of holders are available. The OPTI-LYNX Micro In-Line Holder offers full biocompatibility, while the Direct Connect version threads conveniently into all 10-32 ports.

OPTI-LYNX Traps are the ideal tool for optimizing trapping techniques. Whether separating a peptide digest from its matrix for further analyses or preparing a dilute small molecule sample for LC injection without loss of sample, these columns may be loaded and regenerated repeatedly for maximum value.

## OPTI-LYNX™ Micro Advantages

- Hand-tight quick-connect (quarter-turn) system
- Rated to 6,000 psi - no tools needed
- In-line (BC) and Direct-Connect configurations
- Biocompatible bi-directional cartridges
- New compact design offering lower backpressure
- Larger bed volumes available upon request

In-Line Holder Configuration



## OPTI-LYNX™ Micro Holders

**11-04824-AA**

OPTI-LYNX Micro Direct Connect Holder  
Includes back-end fitting

**11-03924-AA**

OPTI-LYNX Micro In-Line Holder  
Includes fittings and tubing

## OPTI-LYNX™ MICRO CARTRIDGE SELECTION GUIDE

	Bed Volume	Dimensions	Load Rate (mL/min)	Dimension Code	Code	Phase
5 PACKS	4µL	1 x 5mm	0.10 - 5	0 4 7 5 5	T A T B T D T E T F T G T H D Q	C18 SCX C18AQ SAX C8 C4 DVB DVB/SCX
	10µL	1.5 x 5mm	0.20 - 8	0 4 7 5 7	T M T N T O T Q E S	Protein Peptide NID Small Molecule Custom
	20µL	2.1 x 5mm	0.50 - 12	0 4 7 5 9		
	40µL	3.0 x 5mm	1 - 15	0 4 8 0 7		

To calculate the approximate sample capacity of each trap cartridge, we recommend using the ratio 4µg/1µL of bed volume. For more information about how to use this table, please see page 29.

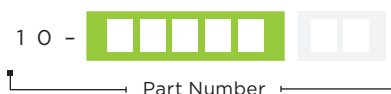

The next-generation EXP2 Nano Trap System provides the finest low-volume hardware and connections to minimize extra column effects and sample dispersion. The EXP2 Nano Trap is extremely versatile and robust for applications requiring trapping in one direction followed by elution in the reverse direction. Applications for the EXP2 Nano Trap include general sample cleanup, sample concentration and removal of detergents or salts at UHPLC pressures.



EXP2 Nano Trap Holders are available in two formats: 10-32 threaded connections for 1/16" tube ports and 6-40 threaded connections for 1/32" tube ports. Multiple bed volumes and phases allow customizable formats to achieve the separation, clean up and concentration most effective for a specific method. Please note the 6-40 holder can be connected to a 6-32 port with the purchase of EXP or EXP2 Fittings. If you are working with 6-32 threads and have questions, please contact an Optimize representative.

The new hand-tight EXP2 Fittings allow the Nano Trap to achieve the highest performance at UHPLC pressures while maintaining a small profile to fit tight spaces in switching valves or injection valves. The Nano Trap is best coupled with narrow bore (25 $\mu$ m, 50 $\mu$ m, 100 $\mu$ m) PEEKsil<sup>®</sup> tubing to deliver top performance.

## EXP<sup>®</sup>2 NANO TRAP SELECTION GUIDE

	Bed Volume	Load Rate (mL/min)	Dimensions	Dimension Code	Code	Phase	
SINGLE TRAP	0.125 $\mu$ L	0.02 - 0.2	180 $\mu$ m x 5mm	0 5 0 9 2	H P	C18	5 $\mu$ m <b>HALO<sup>®</sup></b>
					H Q	C8	
					H R	HILIC	
					H S	Phenyl-Hexyl	
					H T	PFP	
					H U	ES-CN	
	H V	Penta-HILIC					
	0.30 $\mu$ L	0.05 - 0.75	350 $\mu$ m x 5mm	0 5 1 1 9	H A	C18	2.7 $\mu$ m <b>HALO<sup>®</sup></b>
					H B	C8	
					H D	HILIC	
					H E	RP-Amide	
	H F	Phenyl-Hexyl	Peptides ES-C18				
H N							
1 $\mu$ L	0.10 - 2	500 $\mu$ m x 5mm	0 5 1 1 7	H G	C18	3 $\mu$ m <b>EXP<sup>®</sup></b>	
				H H	C8		
				H I	C4		
				H J	HILIC		
				H K	Phenyl-Hexyl		
				H L	SAX		
				H M	SCX		
E S	Custom						

1 5 -		
	Part Number	

To calculate the approximate sample capacity of each trap cartridge, we recommend using the ratio 4 $\mu$ g/1 $\mu$ L of bed volume. For more information about how to use this table, please see page 29.



## EXP<sup>®</sup>2 NANO TRAP DIRECT CONNECT & IN-LINE HOLDERS



### Advantages of the EXP<sup>®</sup>2 Nano Trap

- Rated to 20,000+ psi (1,400+ bar)
- Reduced column volume for superior performance
- For multi-directional and uni-directional trapping
- Lowest swept volume design for peak sharpness

### EXP<sup>®</sup>2 Nano Trap Holders

15-02-05036	EXP2 Nano Trap Direct Connect Holder Includes EXP Fitting, connects to any 10-32 port
15-02-05107	EXP2 Nano Trap In-Line Holder Kit with 10-32 Threads Includes 2 EXP Fittings
15-02-05088	EXP2 Nano Trap In-Line Holder Kit with 6-40 Threads Includes 2 EXP Fittings

EXP<sup>®</sup>2 STEM TRAP

The entire EXP2 Stem Trap and reusable holder are only slightly larger than a standard HPLC fitting. The slim architecture allows it to easily fit into crowded instrument compartments or to connect directly to tightly-spaced injection ports. When tightened by hand, the EXP2 Stem Trap seals to 8,700+ psi. All configurations incorporate wrench flats to enable flawless sealing to 20,000+ psi (1,400+ bar). The unique packed floating stem installs directly into any 10-32 port and automatically adjusts to provide a perfect ZDV connection.

Specialized features, patented technology, precision engineering and state-of-the-art manufacturing make the new EXP2 Stem Trap an unbeatable choice for ultra high-pressure trapping applications.

EXP<sup>®</sup>2 Stem Holder

**15-02-03996** EXP2 Stem Holder  
Includes fittings



actual size

EXP<sup>®</sup>2 STEM TRAP SELECTION GUIDE

	Bed Volume	Load Rate (mL/min)	Dimensions	Dimension Code	Code	Phase	
STEM TRAP KIT	0.17μL	0.005 - 0.1	125μm x 13.5mm	0 3 9 9 7	H P H Q H R	C18 C8 HILIC	5μm <b>HALO<sup>®</sup></b>
REPLACEMENT STEMS (3 PK)	0.17μL			0 3 9 9 2	H S H T H U H V	Phenyl-Hexyl PFP ES-CN Penta-HILIC	
STEM TRAP KIT	0.33μL	0.01 - 0.25	180μm x 13.5mm	0 4 0 0 3			
REPLACEMENT STEMS (3 PK)	0.33μL			0 4 0 0 1	H A H B H D	C18 C8 HILIC	
STEM TRAP KIT	0.68μL	0.02 - 0.5	250μm x 13.5mm	0 4 0 0 9	H E H F H N	RP-Amide Phenyl-Hexyl Peptides ES-C18	
REPLACEMENT STEMS (3 PK)	0.68μL			0 4 0 0 8			
STEM TRAP KIT	1.5μL	0.05 - 1	350μm x 13.5mm	0 4 0 1 5	H G H H H I	C18 C8 C4	3μm <b>EXP<sup>®</sup></b>
REPLACEMENT STEMS (3 PK)	1.5μL			0 4 0 1 4	H J H K H L H M	HILIC Phenyl-Hexyl SAX SCX	
STEM TRAP KIT	2.6μL	0.10 - 2	500μm x 13.5mm	0 4 0 2 1			
REPLACEMENT STEMS (3 PK)	2.6μL			0 4 0 2 0	E S	Custom	

1 5 -                

Part Number

To calculate the approximate sample capacity of each trap cartridge, we recommend using the ratio 4μg/1μL of bed volume. For more information about how to use this table, please see page 29.

STEM TRAP KIT



Holder



Fitting



Stems

Advantages of the  
**EXP<sup>®</sup>2** Stem Trap

- Rated to 20,000+ psi (1,400+ bar)
- Hand-tight and wrench-tight configuration
- Custom packing available
- Available in bed volumes from 0.17 $\mu$ L to 2.6 $\mu$ L
- Low-volume, low-dispersion cartridges
- Auto-adjusting ZDV connection
- Intended for many repeat uses
- For nano flow applications
- New design incorporates integral ferrule into the front-end of the holder. No separate ferrule to lose.

# EXP® TRAP COLUMN



The patented hand-tight EXP Trap Column is rated for use up to 20,000+ psi (1,400+ bar). This unique design connects directly to any injection valve (with 10-32 threads) or in-line with 1/16" stainless tubing for unparalleled convenience and efficiency.

The EXP Cartridge System enables chemists to quickly remove detergents or salts which can affect the ionization process in MS work. This trapping technique can concentrate the sample directly on-line and allows for increased recovery of precious sample material compared to off-line techniques. On-line trapping readily lends itself to automation for high-throughput analysis in UHPLC/MS applications. Free-Turn® architecture allows the user to change cartridges by hand without breaking fluid connections on the holder inlet/outlet.

## EXP® Holders

<b>15-02-03956</b>	EXP Direct Connect Holder Includes fittings
<b>15-02-03946</b>	EXP In-Line Holder Includes fittings
<b>15-02-04041</b>	EXP All-In-One Holder Kit Includes In-Line + Direct Connect holder components and fittings

## EXP® TRAP CARTRIDGE SELECTION GUIDE

	Bed Volume	Load Rate (mL/min)	Dimensions	Dimension Code	Code	Phase	
3 PACKS	4µL	0.10 - 5	1 x 5mm	0 3 9 6 4	H P H Q H R H S H T H U H V	C18 C8 HILIC Phenyl-Hexyl PFP ES-CN Penta-HILIC	5µm <b>HALO®</b>
	10µL	0.20 - 8	1.5 x 5mm	0 3 9 6 9	H A H B H D H E H F H N	C18 C8 HILIC RP-Amide Phenyl-Hexyl Peptides ES-C18	2.7µm <b>HALO®</b>
	20µL	0.50 - 12	2.1 x 5mm	0 3 9 7 3	H G H H H I H J H K H L H M	C18 C8 C4 HILIC Phenyl-Hexyl SAX SCX	3µm <b>EXP®</b>
	40µL	1 - 15	3 x 5mm	0 3 9 7 8	E S	Custom	
	100µL	1 - 20	4.6 x 5mm	0 3 9 8 3			



To calculate the approximate sample capacity of each trap cartridge, we recommend using the ratio 4µg/1µL of bed volume. For more information about how to use this table, please see page 29.

**EXP®**

---

**IN-LINE HOLDER****Advantages of the  
EXP® Trap Column**

- Hand-tight to 20,000+ psi (1,400+ bar)
- Hand-tight trap replacement - no tools
- Uni-directional cartridge
- Custom packing available
- Available in bed volumes from 4µL to 100µL
- Hardened stainless steel end cap eliminates galling
- Auto-adjusting ZDV connections

**EXP®**

---

**DIRECT CONNECT HOLDER**

# GUARD COLUMNS

The analytical column is the heart of any liquid chromatography system and remains the most problematic component. HPLC columns accumulate retained material which can dramatically reduce longevity and cause costly downtime resulting from premature column failure and troubleshooting.

## Why Use A Guard Column?

The best way to protect an analytical column from fouling is to install a guard column between the injection valve and the analytical column. The guard column traps particulates, solvent impurities and retained sample components. The ideal guard column should have no effect on the separation. For best results a guard column with matching bonded phase and optimal hardware configuration should be selected.

## Extra Column Volume

The evolving needs of HPLC applications such as smaller bed-volume columns, higher pressures and increased sensitivity create new demands on guard columns. Many guard column manufacturers overlook the dead volume that occurs when a guard column or holder is connected to the analytical column. The use of pre-swaged or one-piece nut and ferrule designs with fixed tube stems will increase extra column volume (shown in blue) and affect column efficiency. **(Figure 1)**

Other cartridge-style guard column systems require extra connections and tubing, adding to extra column volume and decreasing a system's overall performance. **(Figure 2)**

Figure 1

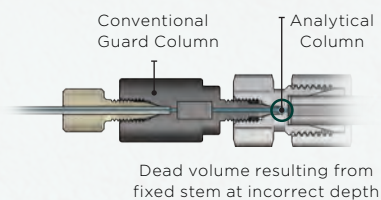
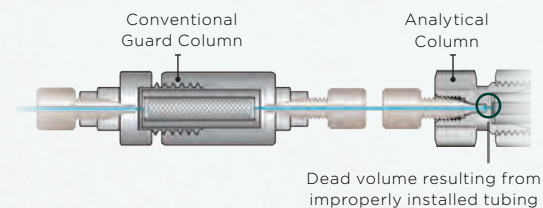
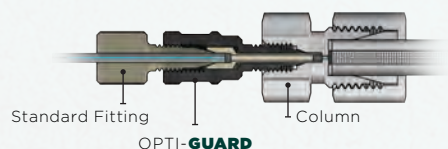

Figure 2



Floating tube stem provides ZDV connection into any port.





## GUIDE TO OPTIMIZE GUARD COLUMNS

	OPTI-GUARD®	OPTI-LYNX™2	EXP®
	1mm Guard	Guard Column	Guard Column
	Pg. 41	*see below	Pg. 42
Maximum Pressure	 <b>HIGH PRESSURE</b> 6K PSI / 400 BAR	 <b>HIGH PRESSURE</b> 6K PSI / 400 BAR	 <b>ULTRA HIGH PRESSURE</b> 20K+ PSI / 1400+ BAR
Dimensions Available	1 x 14mm	2.1 x 5mm 3.0 x 5mm 4.6 x 5mm	1.0 x 5mm 1.5 x 5mm 2.1 x 5mm 3.0 x 5mm 4.6 x 5mm
Hand-Tight Holder/ Hand-Tight Cartridge Change	✓	✓	✓
Holder Fittings Included		✓	✓
Auto Adjusting (ZDV) Port Connection	✓ Floating	✓ Spring-loaded	✓ Spring-loaded
Custom Packing Available	✓	✓	✓
Biocompatible Option	✓		
	<p>The OPTI-GUARD 1mm is an all-in-one solution. The mated holders and cartridges are disposable and designed for use with 1, 2.1, 3.0 and 4.6mm i.d. columns. The OPTI-GUARD is no larger than a standard HPLC fitting.</p>	<p>OPTI-LYNX2 features a quarter-turn, quick-connect, hand-tight holder. The second generation OPTI-LYNX is more affordable and robust yet still allows users to change a cartridge in seconds.</p>	<p>Like the OPTI-LYNX system, the EXP Holder stays plumbed into the LC column. To change a cartridge, simply unscrew the holder cap by hand, replace the cartridge and screw the holder back together by hand. Easy, no tools needed.</p>

\* Please contact Optimize for pressure rating and further product details.

OPTI-GUARD sets the standard for low impact, easy to use pre-column protection. Designed for use with ANY analytical (4.6, 3.0mm i.d.) and narrow-bore (2.1, 1.0mm i.d.) columns, the patented floating stem design automatically adjusts to all manufacturer's tube stop depths for a zero-dead-volume connection every time. The best part? It is no larger than a standard fitting.

As always, custom packing is available.

### OPTI-GUARD® 1mm Guard Column

10-02-00007	C18, 5/Pk
10-02-00010	C8, 5/Pk
10-02-03211	C4, 5/Pk
10-02-00014	Silica, 5/Pk
10-02-00018	Phenyl, 5/Pk
10-02-00022	Cyano/CN, 5/Pk
10-02-00026	Amino/NH2, 5/Pk
10-02-00030	Anion Exchange, 5/Pk
10-02-00034	Cation Exchange, 5/Pk
10-02-04068	DVB, 5/Pk
10-02-03463	Custom Packed, 5/Pk
10-02-01714	Method Development Kit (Assortment of your choice 5/Pk)

### OPTI-GUARD® 1mm Biocompatible Guard Column

10-02-03532	Biocompatible C18, 5/Pk
10-02-04708	Biocompatible C8, 5/Pk
10-02-03534	Biocompatible Silica, 5/Pk
10-02-03538	Biocompatible Cyano/CN, 5/Pk
10-02-03536	Biocompatible Amino/NH2, 5/Pk
10-02-03680	Biocompatible Anion Exchange, 5/Pk
10-02-03683	Biocompatible Cation Exchange, 5/Pk





The EXP Guard Column Cartridge System is rated to 15,000 psi with hand-tight replaceable cartridges. This unique design connects directly to any UHPLC column with the auto-adjusting Titanium Hybrid Ferrule and EXP® Fittings, providing repeated zero-dead-volume connections and easy adjustability between various column types.

Free-Turn® architecture allows the user to change cartridges by hand without breaking fluid connections on the holder inlet/outlet. The combination of low-dispersion and ultra high-pressure capabilities provides effective protection with negligible effects on retention time, plate count and peak shape.

## EXP® Guard Column Advantages

- Hand-tight guard replacement - no tools
- Hardware rated to 20,000+ psi (1,400+ bar)
- Packed guard rated for routine use to 15,000 psi (1,000 bar)
- 1.4µL swept volume (excluding packed bed)
- Hardened stainless steel end cap eliminates galling
- Low-volume, low-dispersion cartridges
- Auto-adjusting ZDV column connection
- Custom packing available

### EXP® Holder

**15-02-03956**

EXP Direct Connect Holder  
Includes fittings

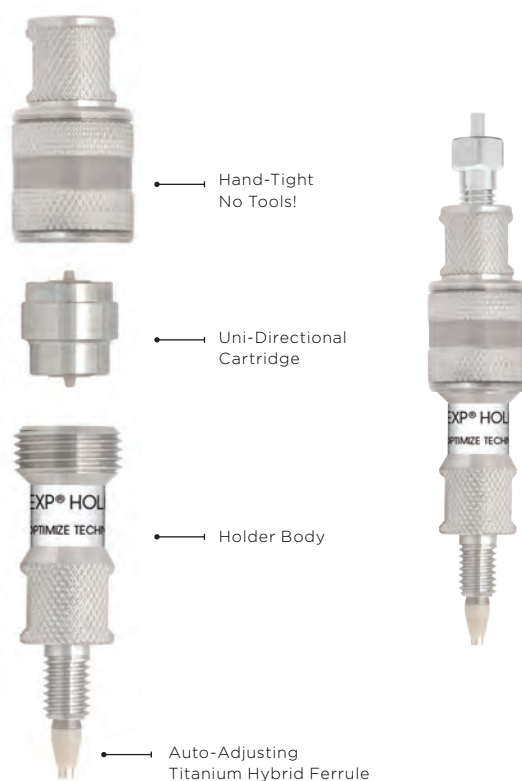

## EXP® GUARD COLUMN SELECTION GUIDE

	Dimensions	Dimension Code	Code	Phase	
3 PACKS	1.0 x 5mm	0 4 1 0 0	H A H B H C H D	C18 C8 C4 HILIC	1.8µm
	1.5 x 5mm	0 4 1 0 2			
	2.1 x 5mm	0 4 1 0 4	H E H F H G H H	C18 C8 C4 HILIC	3µm
	3.0 x 5mm	0 4 1 0 6	H I H J H K	Phenyl-Hexyl SAX SCX	
4.6 x 5mm	0 4 1 0 8	E S	Custom		



For more information about how to use this table, please see page 29.

The cartridge-based EXP Analytical Column System is designed for superior chromatographic analysis with each injection and is rated for routine use up to 20,000 psi.

The new EXP Analytical Column Holders incorporate Free-Turn<sup>®</sup> architecture allowing the user to quickly exchange columns without breaking any fluid connections. The EXP Analytical Column Holders are available in two formats: the standard In-Line format and Direct Connect, allowing the user to bypass additional tubing and connect directly to the detector for even greater resolution. Holder kits include EXP Nuts and Titanium Hybrid Ferrules to ensure repeated zero-dead-volume connections.

The new EXP Analytical Column Hardware is precision machined and held to the highest specifications to ensure excellent performance and repeatability. The column hardware is assembled up to the point of packing, allowing the customer to completely control the resins used, packing processes and testing conditions. Packing fixtures are also available and are compatible with all column dimensions.

### EXP<sup>®</sup> Analytical Column Advantages

- Hardware rated to 20,000+ psi (1400+ bar)
- Cartridge-based format
- Repeated column performance
- Free-Turn<sup>®</sup> architecture for quick exchanges of columns
- Quick connect/disconnect
- Repeated ZDV connections

### EXP<sup>®</sup> Analytical Column Holders

<b>15-70-04448</b>	50mm In-Line Holder Kit
<b>15-70-04450</b>	100mm In-Line Holder Kit
<b>15-70-04454</b>	50mm Direct Connect Holder Kit
<b>15-70-04455</b>	100mm Direct Connect Holder Kit

### EXP<sup>®</sup> Analytical Column Hardware Kits

<b>15-70-04457</b>	1.0mm x 50mm
<b>15-70-04461</b>	1.0mm x 100mm
<b>15-70-04471</b>	2.1mm x 50mm
<b>15-70-04473</b>	2.1mm x 100mm
<b>15-70-04476</b>	3.0mm x 50mm
<b>15-70-04479</b>	3.0mm x 100mm
<b>15-70-04483</b>	4.6mm x 50mm
<b>15-70-04487</b>	4.6mm x 100mm

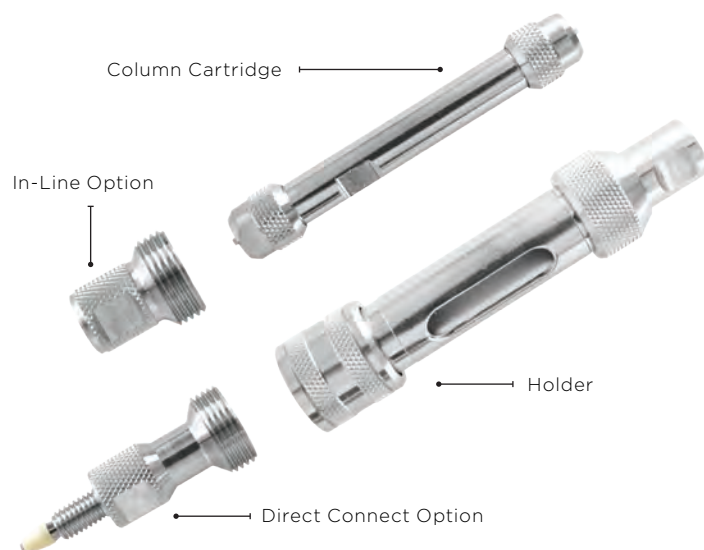

# BACK PRESSURE REGULATORS

Optimize flow-through back pressure regulators utilize an active mechanism to maintain steady back pressure across a range of mobile phase viscosities and flow rates. Placing a back pressure regulator downstream from the detector will prevent solvent decompression and bubble formation in the flow cell, reducing baseline noise and drift.

Each regulator has an internal volume of 100 $\mu$ L and is available in pre-set pressures of 10, 30, 60, 100, or 150 psi.

PLACE A BACK PRESSURE REGULATOR  
DOWNSTREAM FROM THE DETECTOR TO PREVENT SOLVENT  
OUTGASSING AND BUBBLE FORMATION IN THE FLOW CELL,  
REDUCING BASELINE NOISE AND DRIFT.

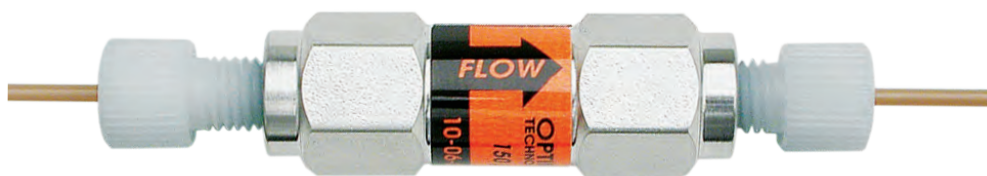

## Back Pressure Regulators

<b>10-06-00120</b>	Back Pressure Regulator, 10 psi
<b>10-06-00128</b>	Back Pressure Regulator, 30 psi
<b>10-06-00129</b>	Back Pressure Regulator, 60 psi
<b>10-06-00130</b>	Back Pressure Regulator, 100 psi
<b>10-06-00132</b>	Back Pressure Regulator, 150 psi

All regulators include fittings



## HPLC & UHPLC OEM SYSTEMS

In the following pages you will find replacement components designed specifically for OEM HPLC/UHPLC solvent delivery systems. At Optimize, all components are precision machined to the most exacting standards in the industry. All phases of the manufacturing process are controlled to ensure the highest quality. From the individual matching of check valve ball and seat sets to the proprietary blend of materials in our seals – experience Optimize quality.

**EVERY REPLACEMENT COMPONENT WE OFFER IS DESIGNED TO MEET OR EXCEED ORIGINAL EQUIPMENT SPECIFICATIONS. GUARANTEED.**

### Optimize and OEM Components

Most instrument manufacturers will insist optimal instrument performance depends on exclusively using components that match their performance specifications. We could not agree more. Every Optimize replacement component is guaranteed to meet or exceed original equipment specifications. For example, several major OEM manufacturers incorporate Optimize components as original equipment on new HPLC and UHPLC instruments. Optimize OEM partners appreciate the positive impact Optimize products have on instrument performance.

### Optimize Innovation

Innovation is our driving force. We offer a comprehensive selection of components for most brands of HPLC systems and are always developing new products to save customers time and money. Should you need a product that is not listed in this catalog, please call us to discuss your fluid handling needs.



# UHPLC & HPLC FINDER™

	BRAND	MODELS	PAGE NO.
A	Agilent	1050, 1090, 1100, 1200, 1220, 1260	<b>55-57</b>
	Alcott	Micromeritics 760, 765	<b>59</b>
	Anspec	SM 909	<b>59</b>
B	Beckman/Altex	100A, 110A/B, 112/112M, 114/114M, 116, 118, 125, 126, 127, 128	<b>58</b>
	Bischoff	2200, 2250, 2200 Microbore	<b>59</b>
D-G	Dionex	DQP, GPM-1&2, DRP, DXP, AGP, 2000, 4000, GP-40, IP-20, GP-50, IP-25	<b>60</b>
	ESA	Model 580, 582, 584	<b>65-66</b>
	Gilson	See Varian	<b>69-70</b>
H-J	Hewlett Packard	See Agilent	<b>55-57</b>
	Hitachi	655, L-6000, L-6200/6200A, L-7100 (LaChrom), L-2100, Smash Pump, L-2130	<b>61</b>
	Jasco	BIP-1, 880/980 Series, PU-2080, 2085, 2089, 1580-C02, 980, 1586, 2086, 986	<b>62</b>
L-P	LDC/Milton Roy	All Analytical Pumps (including Constametric, Minimetric, Minipump, Mini Duplex)	<b>67</b>
	LKB/Amersham/ Pharmacia	2150, 2248, 2500	<b>63</b>
	PerkinElmer	Series 1, 2, 3, 3B, 4, 10, 100, Model 200, 250, 400, 410, 620, Integral 4000	<b>64</b>
R-S	Rainin	See Varian	<b>69-70</b>
	Shimadzu	LC-30, LC-30ADSF, i-Series, LC-2040, LC-2040C, LC-2030, LC-2030C, LC-20ABXR, LC-20ADXR, LC-10AD, LC-10ADVP, LC-10AT, LC-10ATVP, LC-20AB, LC-20AT, LC-20AD, LC-20ADsp, LC-20ADnano LC-20AP, LC-6A, LC-6AD, LC-6AEF, LC-7A, LC-8A, LC-9A, LC-10AS, LC-600, LC-20610, LC-2010, GPC-20 & 50, SIL-10ADVP, GFP	<b>65-66</b>
	Spectra-Physics	8700, 8800, 8810, IsoChrom, P-Series, 8700XR, 8750	<b>68</b>
T-W	Thermo	Surveyor L Pump, also see LDC/Milton Roy, Spectra-Physics	<b>67-68</b>
	Varian, Gilson/Rainin	2010, 2510, 9000 Star/9000 Series, ProStar 210/215, 220, 230, 240, All Pumps with 5, 10 or 25mL S/SC Heads, HP, HPX, HPXL, SD 200/300	<b>69-70</b>
	Waters	Alliance, 2690, 2695, 2790, 2795, M45/45G, M501, 510, 515, 590, 600/600E, 610, 616, 625/626, 650, 6000, 6000A, 6K/6KA, DeltaPrep 3000, (#3, #4, #5 and #6 Heads), 1525, 1515, LC Module 1, GPC/V200	<b>71-73</b>



A properly functioning check valve is virtually unnoticeable. An improperly functioning check valve can lead to a noisy baseline, pressure fluctuations and inconsistent flow. A check valve can have a large impact on the performance of your pump. It is imperative when choosing replacement check valves to select the very best. The OPTI-MAX Check Valve System is the very best. Read on to discover the innovations in our OPTI-MAX Check Valve line.

## CHECK VALVES ARE A CRUCIAL, YET OFTEN OVERLOOKED COMPONENT OF THE HPLC SYSTEM.

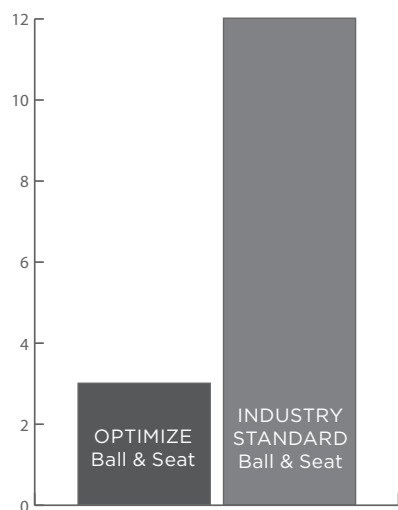

Bubbles of nitrogen/  
minute at 90 psi  
which leak from  
ball & seat.

### A BETTER CHECK VALVE

Tighter specifications make a better valve. A check valve can only function effectively if it activates and seals properly in response to the piston cycle. The seating process is fairly simple. The ball lands on the seat and creates a seal. However, there are many factors that contribute to optimal seating. Optimize check valves are designed and engineered to be the most responsive in the industry.

Each ball and seat set is individually matched to ensure a lock-and-key fit. This guarantees 3 bubbles/minute or less in the industry standard nitrogen bubble test. Common acceptable standards are 12 bubbles or less. Optimize check valves minimize the ball travel distance within the check valve. Less travel distance equals quicker seating and more accurate pump metering.

## OPTI-MAX®

## A UNIVERSAL SOLUTION

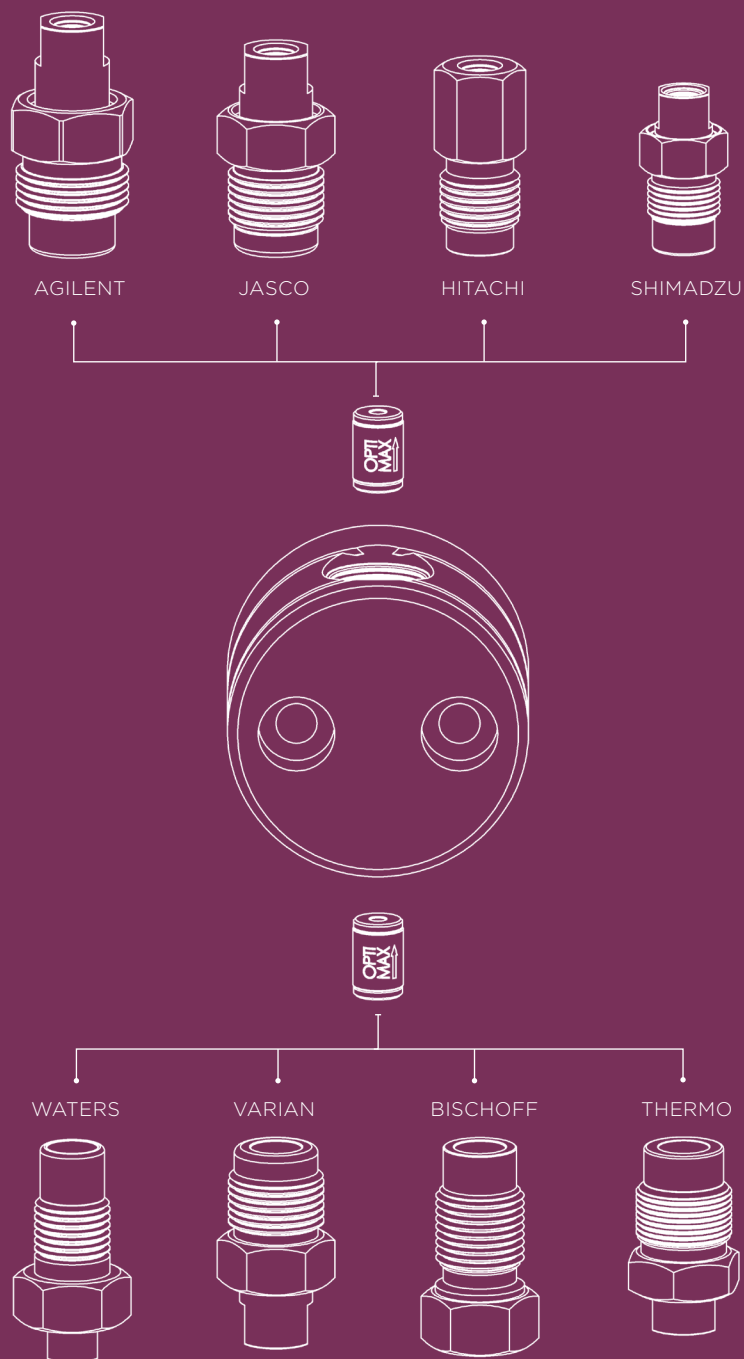

A single OPTI-MAX cartridge is interchangeable across multiple pump brands and can function in either the inlet or outlet position.

The same OPTI-MAX cartridge fits into OPTI-MAX housings for pumps manufactured by Waters, Shimadzu, Agilent/HP, and many other OEM solvent delivery systems.

The modular cartridge system allows you to minimize the number of spare check valve cartridges you keep on hand and dramatically reduce the cost of inventory required to cover maintenance needs.

## OPTI-MAX® FREE-TURN® HOUSING

Optimize was the first in the industry to introduce the concept of the OPTI-MAX Free-Turn® housing. The thread tightens a check valve housing into the pump head and spins independently from the inner housing body. The check valve can then be changed without disconnecting any tubing. An idea born in efficiency.

Most OPTI-MAX Check Valve housings feature the Free-Turn design. To see if housings are available for your system, look for the Free-Turn logo .

OPTI-MAX® FREE-TURN® HOUSINGS  
CAN BE REMOVED WITH THE TUBING STILL ATTACHED,  
ACCELERATING CHECK VALVE MAINTENANCE WHILE  
REDUCING FITTING WEAR.

### FREE-TURN® IN ACTION



Place wrench on the hex nut and turn. The hex nut or thread ring will turn independently of the fitting connection.

Continue to unscrew the thread ring until the entire check valve assembly is removed from the pump head.

Discard old check valve cartridge & replace with new cartridge.

Install entire assembly into pump head.



OPTI-MAX cartridges are available in several different sizes and combinations of body and ball/seat materials. All cartridges are manufactured and leak tested to meet the highest performance standards.

## OUR RECOMMENDATION: STAINLESS/CERAMIC

For high mechanical strength, stainless steel cartridges are the best choice. Ceramic ball & seat sets have a higher density, which can make the valve more responsive and help the ball seat faster in lighter solvents.

For biocompatible HPLC systems with nonmetallic flow paths or high percentages of THF, use PEEK cartridges with ceramic balls & seats.

The cartridge body materials listed above are also available with ruby and sapphire ball & seat combinations.

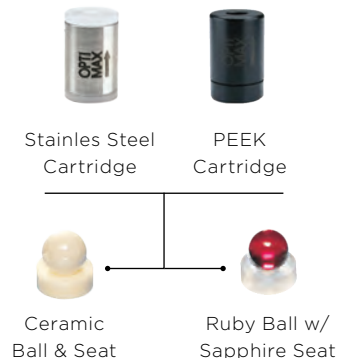

## CARTRIDGE MATERIAL OPTIONS | 2 PACKS



<b>1/32"</b>	<b>10-39-02004</b>	Cartridge fits in all housings using 1/16" and 1/8" cartridge. Only available in PEEK/PPS body with ruby sapphire ball & seat.
	<b>10-46-02004</b>	<b>Recommended:</b> Microbore stainless steel cartridge with ceramic ball & seat
	<b>10-48-02004</b>	Microbore PEEK cartridge with ceramic ball & seat
	<b>10-47-02004</b>	Microbore stainless steel cartridge with ruby ball & sapphire seat
<b>1/16"</b>	<b>10-49-02004</b>	Microbore PEEK cartridge with ruby ball & sapphire seat
	<b>10-56-02004</b>	<b>Recommended:</b> Standard stainless steel cartridge with ceramic ball & seat
	<b>10-58-02004</b>	Standard PEEK cartridge with ceramic ball & seat
	<b>10-57-02004</b>	Standard stainless steel cartridge with ruby ball & sapphire seat
<b>1/8"</b>	<b>10-59-02004</b>	Standard PEEK cartridge with ruby ball & sapphire seat
	<b>10-66-02005</b>	<b>Recommended:</b> stainless steel cartridge with ceramic ball & seat
	<b>10-68-02005</b>	PEEK cartridge with ceramic ball & seat
	<b>10-67-02005</b>	Stainless steel cartridge with ruby ball & sapphire seat
<b>3/16"</b>	<b>10-69-02005</b>	PEEK cartridge with ruby ball & sapphire seat
	<b>10-76-02004</b>	OPTI-MAX EXP stainless steel cartridge with ceramic ball & seat
	<b>10-77-02004</b>	OPTI-MAX EXP stainless steel cartridge with ruby ball & sapphire seat
<b>1/16"</b>	<b>10-86-02004</b>	OPTI-MAX EXP stainless steel cartridge with double ceramic balls & seats



We cannot guarantee the OPTI-MAX check valve cartridge will fit in OEM housings. OPTI-MAX cartridges must be used with OPTI-MAX housing for optimal results.

## SEALS & PISTONS

By design, seals and pistons are a consumable part of an HPLC pump and should be replaced on a regular preventative maintenance schedule. To maintain peak performance and avoid unplanned downtime, piston seals should be replaced every three to six months. While sapphire pistons require inspection every six months with yearly or as-needed replacement.

### SEALS

Optimize piston seals are the longest lasting seals on the market. Machined from either of two proprietary polymer blends, UHMW-PE or ITB, Optimize seals provide ultimate high pressure sealing capacity. For mostly aqueous buffered mobile phases, OPTI-SEAL UHMW-polyethylene is the preferred choice. Specially designed to be more resistant to abrasion and wear than standard polyethylene seals, the seals can last up to seven times longer under mostly aqueous conditions. Despite the UHMW-PE's durability, the material has a coefficient of friction approaching that of PTFE. The homogenous polymer nature leads to less shedding. When it does occur, a larger, more fibrous particle is produced and is easily caught by a filter frit.

PTFE-based Improved Blend (ITB) seals are a superior choice for applications with elevated temperatures, high organic content, or when the broadest possible solvent compatibility is required. ITB seals tend to be softer than those made from UHMW-PE, making the seals more forgiving at high pressures where piston side-loading or misalignment may occur. This softer nature also leads to more shedding. However, the ITB proprietary blend is designed to shed particles that are large enough to be caught at the surface of a standard 2 $\mu$ m frit and not embed within the frit.



### PISTONS

Optimize sapphire pistons offer optimal concentricity and resistance to wear. Each sapphire rod is specifically cut in relation to the grain of the crystal lattice, yielding maximum resistance to breakage with superior wear characteristics. Attachment of the rod to the piston ferrule is performed through a proprietary process ensuring concentricity. This is an important and often overlooked procedure that has a direct effect on seal lifetime.



# SEAL FORM TOOL KIT

Installing a piston seal can be a tricky undertaking. A relatively small seal must fit into the seal cavity in such a way to ensure the seal is inserted evenly without distortion or damage. The Optimize Seal Forming/Insertion Tool Kit is specifically designed for easy and successful installation.

The kit contains three tools to accommodate all HPLC piston seals. One end has a beveled cavity for seal forming while the other end is an insertion support for perfect seal installation. Each kit contains instructions for maximizing seal life and a Solvent Compatibility Guide to aid in seal material selection.

## THE KIT INCLUDES THREE SIZES ASSURING THE PERFECT SEAL FIT EVERY TIME



Forming cavities are available in three different sizes allowing the user to choose the best tool for seal installation.

The piston seal is formed by pressing the tool onto the seal jacket.

The seal is then pressed into the pump head seal cavity using the insertion support.

### Seal Forming/Insertion Tools

<b>10-10-02695</b>	Seal Forming/Insertion Tool Kit Includes three Forming/Insertion Tools (Small, Medium, Large), instruction booklet & Solvent Compatibility Guide
<b>10-10-02699</b>	Small Seal Forming/Insertion Tool
<b>10-10-02700</b>	Medium Seal Forming/Insertion Tool
<b>10-10-02701</b>	Large Seal Forming/Insertion Tool



**TIP:** For best performance, always use methanol or isopropanol to presoak piston seals for five to ten minutes prior to installation. Wet all mating surfaces (seal, piston, seal cavity) as the seal is formed and installed.

OPTI-MAX<sup>®</sup> CONVERSION KITS

Dionex  
25-58-01242



Hitachi  
28-46-02148



LDC  
31-56-02153

OPTI-MAX Conversion Kits contain all the check valves necessary for your HPLC pump. Kits are grouped under single part numbers and priced up to 20% off list.

Each kit includes all the OPTI-MAX check valve housings and cartridges needed to convert an HPLC instrument. Simply find your HPLC pump/brand model in the list below and use the conversion kit part number. Each kit includes our recommended stainless steel/ceramic OPTI-MAX cartridges. Please note, OPTI-MAX PEEK cartridges are supplied for listed biocompatible systems. It is also possible to substitute an alternate cartridge material at the same kit price.

BRAND	PUMP MODEL	KIT PART #	INLETS	OUTLETS
Agilent/HP	1090 Systems	<b>27-38-01959</b>	1	1
	1050/1100/1200/1220/1260	<b>27-56-01330</b>	0	1
Beckman	100A, 126,	<b>22-66-02137</b>	2	2
	110A/B, 112/112M, 114/114M, 116	<b>22-66-02138</b>	1	1
Bischoff	2200 Microbore	<b>24-46-02141</b>	1	1
	2200, SM909, 760	<b>24-56-02140</b>	1	1
Dionex	DXP, GP-50/IP-25 DQP,	<b>25-58-02143</b>	1	1
	GPM-1, GPM-2, DRP,		1	1
	AGP, 2000, 4000		1	1
Gilson/Rainin	5, 10 & 25mL Head	<b>26-56-02144</b>	1	1
Hitachi	L-7100, L-2130	<b>28-46-02148</b>	1	1
Jasco	BIP-1	<b>42-56-02150</b>	2	2
	880, 980	<b>42-56-02151</b>	1	1

# OPTI-MAX<sup>®</sup> CONVERSION KITS

BRAND	PUMP MODEL	KIT PART #	INLETS	OUTLETS
LDC/Milton Roy	Minipump, Minimetric	<b>31-56-02152</b>	1	1
	Constametric, Mini Duplex	<b>31-56-02153</b>	2	2
LKB/Amersham/ Pharmacia	2150, 2248, 2500	<b>32-46-02154</b>	2	2
PerkinElmer	4, 200, 250, 400, 410, 620, 4000	<b>33-56-02157</b>	2	1
Shimadzu	LC-10A, 9A, 600	<b>34-46-02158</b>	2	2
	LC-AT, ATP	<b>34-46-02160</b>	1	1
	LC-20AB, AD, ADsp, ADnano AT, LC-10ADVP, 2010, GPC-20 & 50 (100µL Head), ESA 582 & 584	<b>34-46-02627</b>	2	2
	LC-10AS, 6A	<b>34-56-02159</b>	1	1
	LC-20AP, 8A	<b>34-66-02114</b>	2	2
	LC-2040, LC-2040C, LC-2030, LC-2030C LC-30ADSF, i-Series, LC-20ABXR/ ADXR	<b>34-86-04139</b>	2	2
	LC-30	<b>34-86-05140</b>	2	2
	Spectra-Physics	8700, 8800, 8810	<b>35-56-02161</b>	1
	IsoChrom, P-Series	<b>35-56-02162</b>	1	1
Thermo	Surveyor L-Pump	<b>50-46-03645</b>	1	1
Varian	9000 Star, 9010, 9012 ProStar 220, 230, 240	<b>38-56-01704</b>	0	1
	2010	<b>38-56-02164</b>	2	2
	2510	<b>38-56-02165</b>	1	1
Waters	616	<b>39-46-02168</b>	2	2
	625/626	<b>39-48-02170</b>	2	2
	Alliance 2690, 2695, 2790, 2795	<b>39-46-02187</b>	2	0
	100µL/Dual Head Systems	<b>39-56-02166</b>	2	2
	100µL/Single Head Systems	<b>39-56-02186</b>	1	1
	Extended Flow Systems	<b>39-66-01712</b>	1	1
	225µL/Head	<b>39-66-02167</b>	2	2
	400µL & 900µL/Head	<b>39-66-02169</b>	0	2



PerkinElmer  
33-56-02157



Shimadzu  
34-46-02158



Waters  
39-46-02187



Waters  
39-48-02170

# AGILENT / HEWLETT PACKARD

---

Optimize has developed the new OPTI-MAX 600 bar Active Inlet replacement cartridge (AIV). The AIV is comparable in price to the 400 bar active inlet cartridge offered by Agilent.

The OPTI-MAX 600 bar AIV utilizes the proprietary OPTI-MAX technology with wetted materials of 316 SS, PEEK and zirconia (ceramic) for complete compatibility and reliability in both 400 bar and 600 bar applications. The OPTI-MAX Zirconia ball/seat sets are the best in the industry and are individually tested to perform at 3 bubbles or less in the industry-standard 90 psi nitrogen leak test. The OPTI-MAX AIV withstands well over 20,000 psi as an assembled cartridge. Ball travel is minimized allowing the cartridge to exhibit extremely low pulsation in both 600 bar and 400 bar applications. The rugged 316 stainless steel OPTI-MAX AIV cartridge body is easily inserted and tightened for the higher pressure application of 600 bar instruments. The cartridge is completely compatible with both 600 and 400 bar instruments.

By choosing the OPTI-MAX 600 bar AIV cartridge, laboratories with multiple Agilent 400 bar and 600 bar instruments need only purchase and inventory one OPTI-MAX AIV cartridge. Maintenance and repair become much simpler and less costly.

Please note: this cartridge is not compatible with valve body 0491-0131

## OPTI-MAX® 600 BAR AIV CHECK VALVE CARTRIDGE FOR AGILENT SYSTEMS

Part #	OEM #
27-38-04713	G1312-60020, 5062-8562



### Compatible Pumps

Agilent 1100 Quaternary Pump (G1311A)  
 Agilent 1100 Binary Pump (G1312A)  
 Agilent 1100 Capillary Pump (G1376A)  
 Agilent 1200 Isocratic Pump (G1310A)  
 Agilent 1200 Binary Pump (G1312C)  
 Agilent 1260 Infinity Binary Pump (G1312B)  
 Agilent 1260 Infinity Isocratic Pump (G1310B)  
 Agilent 1260 Infinity Quaternary Pump (G1311B)  
 Agilent 1260 Infinity Quaternary Pump VL (G1311C)

### Key Features

- Wetted materials: 316 SS, PEEK and zirconia (ceramic)
- Compatible with both 400 bar and 600 bar applications
- Rated to 20,000+ psi
- OPTI-MAX Zirconia (ceramic) ball/seat set individually tested
- Reduces inventory
- Comparable in price to the standard 400 bar Agilent replacement cartridge

## OPTI-MAX® CHECK VALVES

### Agilent/HP 1050, 1100, 1200, 1220, 1260

		OEM #
<b>27-56-01330</b>	OPTI-MAX Outlet Housing & Cartridge	G1311-60012, G1312-60012
<b>10-56-02004</b>	OPTI-MAX Replacement Cartridges, 1/8" Ball, 2/Pk	
<b>27-38-04713</b>	OPTI-MAX 600 bar AIV Replacement Cartridge	G1312-60020, 5062-8562
<b>27-46-05033</b>	OPTI-MAX Passive Inlet Housing & Cartridge for Agilent 1220 and 1260 only	G1312-60066
<b>10-46-02004</b>	OPTI-MAX Replacement Cartridges, 1/16" Ball, 2/Pk	

OPTIONS: Stainless steel/ceramic OPTI-MAX Cartridges are listed above. For other options, please see page 50.

### Agilent/HP 1090

		OEM #
<b>27-38-00680</b>	Inlet Housing & Cartridge	79835-25211
<b>27-38-00682</b>	Outlet Housing & Cartridge	79835-25211
<b>27-38-00672</b>	Replacement Cartridges, 2/Pk	79835-67101

## SEALS, PISTONS & OTHER PARTS

### Agilent/HP 1050, 1100

		OEM #
<b>27-36-01570</b>	OPTI-SEAL UHMW-PE* Piston Seal	0905-1420
<b>27-36-01571</b>	OPTI-SEAL UHMW-PE* Piston Seal, 10/Pk	
<b>27-36-01572</b>	ITB PTFE** Piston Seal	5063-6589
<b>27-36-01573</b>	ITB PTFE** Piston Seal, 10/Pk	
<b>27-36-03073</b>	PTFE*** Pump Seal, Green, Premium Grade	
<b>27-36-03074</b>	PTFE*** Pump Seal, Green, Premium Grade, 10/Pk	
<b>27-36-02364</b>	OPTI-SEAL UHMW-PE* Wash Seal	0905-1175
<b>27-36-02365</b>	OPTI-SEAL UHMW-PE* Wash Seal, 10/Pk	
<b>27-36-02366</b>	ITB PTFE** Wash Seal	0905-1175
<b>27-36-02367</b>	ITB PTFE** Wash Seal, 10/Pk	
<b>27-36-02851</b>	Gasket Wash Seal, 6/Pk	5062-2484
<b>27-04-02852</b>	PTFE Frits, 5/Pk	01018-22707
<b>27-31-02853</b>	2-in-1 Seal Cap (Replaces OEM Gold Seal - see next page for details)	5067-4728, 5062-2485
<b>27-34-00658</b>	Sapphire Piston	5063-6586

\*UHMW-PE - Ultra High Molecular Weight Polyethylene

\*\*ITB PTFE - Improved PTFE Blend

\*\*\*Premium grade PTFE for maximum chemical compatibility and wear resistance



OPTI-MAX for Agilent



AIV Replacement Cartridge



Agilent Passive inlet



Agilent/HP 1090, Outlet Housing & Cartridge



27-36-01570



27-36-02364



27-36-02366



27-36-01572



27-34-00658

## AGILENT / HEWLETT PACKARD



2-in-1 Seal Cap on Agilent

**2-IN-1 SEAL CAP FOR 1050/1100/1200**

The 2-in-1 Seal Cap replaces both the OEM outlet gold seal and outlet cap with a single component. Use it on purge valves, OEM outlet check valves or anywhere on 1050/1100/1200 systems where gold seals and outlet caps are required.

**Agilent/HP 1050, 1100, 1200**

<b>27-31-02853</b>	2-in-1 Seal Cap	<b>OEM #</b> 5062-2485, 5001-3707, 5067-4728
--------------------	-----------------	---

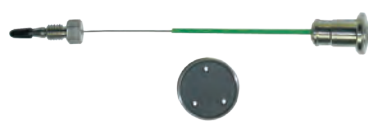
Autosampler  
Replacement Parts

## AUTOSAMPLER REPLACEMENT PARTS

**Agilent/HP 1100, 1200**

<b>27-31-03212</b>	Rotor Seal Assembly	<b>OEM #</b> 0100-1853
<b>27-31-03329</b>	Needle Seat Assembly	G1313-87101

**Agilent/HP 1050**

<b>27-31-03603</b>	Rotor Seal	<b>OEM #</b> 0101-0626
--------------------	------------	---------------------------

**Agilent/HP 1090**

<b>27-31-03649</b>	Rotor Seal, 3 Grooves, Polyimide	<b>OEM #</b> 7010-039
<b>27-31-03670</b>	Rotor Seal, 2 Grooves, Polyimide	0101-0623

Rotor Seal  
27-31-03603

## LAMPS

**Agilent/HP**

<b>27-32-02844</b>	Deuterium Lamp, 1050C, 1050DAD, 1090, 1040	<b>OEM #</b> 79883-60002
<b>27-32-02845</b>	DoubleLife Deuterium Lamp, 1100, 1200 DAD	5181-1530, 2140-0813
<b>27-32-02846</b>	DoubleLife Deuterium Lamp, 1100, 1200 VWD	G1314-60100
<b>27-32-02715</b>	Deuterium Lamp, 1100 VWD G1314A	G1314-60100
<b>27-32-04038</b>	Doublelife Deuterium Lamp, 1050	79883-60002

Agilent 1100 DAD  
27-32-02845



## OPTI-MAX® CHECK VALVES

**100A, 110A/B, 112/112M, 114/114M,  
116, 118, 125, 126, 127, 128** 

		OEM #
<b>22-66-00516</b>	OPTI-MAX Inlet Housing & Cartridge	240720
<b>22-66-00520</b>	OPTI-MAX Outlet Housing & Cartridge	240721
<b>10-66-02005</b>	OPTI-MAX Replacement Cartridges, 3/16" Ball, 2/Pk	

OPTIONS: Stainless steel/ceramic OPTI-MAX Cartridges are listed above.  
For other options, please see page 50.

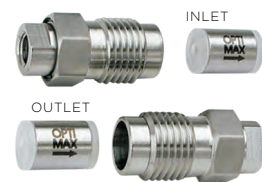

OPTI-MAX for Beckman/Altex

# BISCHOFF

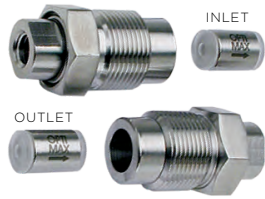

OPTI-MAX  
For Bischoff



24-34-00559



24-36-00573



24-36-00574

## OPTI-MAX® CHECK VALVES

### Bischoff 2200, 2250, Anspec SM909, Alcott Micromeritics 760, 765 (Analytical Versions)

		OEM #
<b>24-56-00576</b>	OPTI-MAX Inlet Housing & Cartridge	2200-0220, 760/25602/00
<b>24-56-00581</b>	OPTI-MAX Outlet Housing & Cartridge	2200-0230, 760/25604/00
<b>10-56-02004</b>	OPTI-MAX Replacement Cartridges, 1/8" Ball, 2/Pk	

### Bischoff 2200, Anspec SM909, Alcott Micromeritics 760 (Microbore Versions), 765

		OEM #
<b>24-46-00585</b>	OPTI-MAX Inlet Housing & Cartridge	2200-0120, 760/25602/01
<b>24-46-00589</b>	OPTI-MAX Outlet Housing & Cartridge	2200-0130, 760/25604/01
<b>10-46-02004</b>	OPTI-MAX Replacement Cartridges, 1/16" Ball, 2/Pk	

OPTIONS: Stainless steel/ceramic OPTI-MAX Cartridges are listed above. For other options, please see page 50.

## SEALS & PISTONS

### Bischoff 2200, Anspec SM909, Alcott Micromeritics 760, 765 (Analytical Versions)

		OEM #
<b>24-34-00559</b>	Sapphire Piston	2200-0210, 760/25803/00

### Bischoff 2200, Anspec SM909, Alcott Micromeritics 760 (Microbore Versions), 765

		OEM #
<b>24-36-00573</b>	ITB PTFE** Piston Seal	2200-0112, 760/25601/01
<b>24-36-00575</b>	ITB PTFE** Piston Seal, 10/Pk	
<b>24-36-00574</b>	Piston Seal Support Ring	2200-0111, 760/25603/01

\*\*ITB PTFE - Improved PTFE Blend

## OPTI-MAX® CHECK VALVES

**GP-40\*/IP-20\*, DQP, GPM-1, DRP, GPM-2, DXP, AGP (Analytical), 2000, 4000, GP-50/IP-25**

		OEM #
<b>25-58-00613</b>	OPTI-MAX Inlet Housing & Cartridge	047660, 38273
<b>25-58-00612</b>	OPTI-MAX Outlet Housing & Cartridge	047661, 42761
<b>10-58-02004</b>	OPTI-MAX Replacement Cartridges, 1/8" Ball, 2/Pk	

OPTIONS: PEEK/ceramic OPTI-MAX Cartridges are listed above. For other options, please see page 50.

\*The OPTI-MAX Check Valves above fit GP-40/IP-20 pumps. Users of microbore versions of these pumps should order OPTI-MAX microbore (1/16") cartridges. Please see page 50.

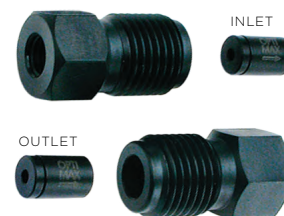

OPTI-MAX for Dionex

## PISTONS & SEALS

**GP-40/IP-20 (Analytical), DQP, GPM-1, DRP, GPM-2, DXP, AGP (Analytical), 2000, 4000**

		OEM #
<b>25-36-00597</b>	OPTI-SEAL UHMW-PE* Piston Seal (Hastelloy C® Spring)	40859
<b>25-36-00598</b>	OPTI-SEAL UHMW-PE* Piston Seal (Hastelloy C® Spring), 10/Pk	
<b>25-36-00599</b>	UHMW-PE* Piston Seal, (Elastomer O-Ring)	35686
<b>25-36-00600</b>	UHMW-PE* Piston Seal, (Elastomer O-Ring), 10/Pk	
<b>25-36-00601</b>	Back-Up Seal, for all models except GP40/IP20	36901
<b>25-36-00602</b>	Back-Up Seal, for all models except GP40/IP20, 10/Pk	

\*UHMW-PE - Ultra High Molecular Weight Polyethylene



25-36-00597



25-36-00599



25-36-00601

## LAMPS

Dionex		OEM #
<b>25-32-02081</b>	Deuterium Lamp, Dionex VDM-1, DSA-1	
<b>25-32-02820</b>	Deuterium Lamp, Dionex CES 1, VDM-2	40651

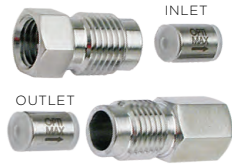

Dionex  
25-32-02081

OPTI-MAX for  
L-7100

28-36-00690



28-36-00691

# HITACHI

## OPTI-MAX® CHECK VALVES

### L-7100 (LaChrom), L-2130

		OEM #
<b>28-46-02092</b>	OPTI-MAX Inlet Housing & Cartridge	ANO-0836, 810-1004, 809-1408
<b>28-46-02094</b>	OPTI-MAX Outlet Housing & Cartridge	ANO-0837, 810-1005, 809-1409
<b>10-46-02004</b>	OPTI-MAX Replacement Cartridges, 1/16" Ball, 2/Pk	

OPTIONS: Stainless steel/ceramic OPTI-MAX Cartridges are listed above.  
For other options, please see page 45.

### L-2100, Smash Pump, L-2130

<b>28-39-02092</b>	OPTI-MAX Inlet Housing & Cartridge
<b>28-39-02094</b>	OPTI-MAX Outlet Housing & Cartridge
<b>10-39-02004</b>	OPTI-MAX Check Valve Cartridge Replacement, Microbore 1/32", 2/Pk

## SEALS

### 655, L-6000, L-6200/L-6200A, L-7100 (LaChrom), L-2100, Smash Pump

		OEM #
<b>28-36-00690</b>	OPTI-SEAL UHMW-PE* Piston Seal	655-1080
<b>28-36-00692</b>	OPTI-SEAL UHMW-PE* Piston Seal, 10/Pk	
<b>28-36-00691</b>	OPTI-SEAL UHMW-PE* Piston Seal (Hastelloy C® Spring)	
<b>28-36-00693</b>	OPTI-SEAL UHMW-PE* Piston Seal (Hastelloy C® Spring), 10/Pk	

\*UHMW-PE - Ultra High Molecular Weight Polyethylene

## OPTI-MAX® CHECK VALVES

### BIP 1

		OEM #
<b>42-56-01038</b>	OPTI-MAX Inlet Housing & Cartridge	6260-H101A
<b>42-56-01043</b>	OPTI-MAX Outlet Housing & Cartridge	6260-H102A
<b>10-56-02004</b>	OPTI-MAX Replacement Cartridges, 1/8" Ball, 2/Pk	

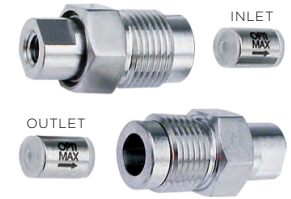

OPTI-MAX for BIP 1

### 880/980 Series

		OEM #
<b>42-56-01544</b>	OPTI-MAX Inlet Housing & Cartridge	6560-H405A
<b>42-56-01546</b>	OPTI-MAX Outlet Housing & Cartridge	6560-H404A
<b>10-56-02004</b>	OPTI-MAX Replacement Cartridges, 1/8" Ball, 2/Pk	

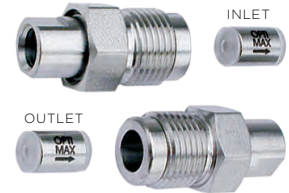

OPTI-MAX  
for 880/980 Series

OPTIONS: Stainless steel/ceramic OPTI-MAX Cartridges are listed above.  
For other options, please see page 50.

## SEALS & PISTONS

### BIP-1, PU-2080, 2085, 2089, 1580-C02, 980, 880, 1586, 2086, 986

		OEM #
<b>42-36-01357</b>	OPTI-SEAL UHMW-PE* Piston Seal	6560-H148, H149A
<b>42-36-01358</b>	OPTI-SEAL UHMW-PE* Piston Seal, 10/Pk	
<b>42-36-01355</b>	ITB PTFE** Piston Seal	6560-H148-PE, H149A
<b>42-36-01356</b>	ITB PTFE** Piston Seal, 10/Pk	
<b>42-34-01354</b>	Sapphire Piston	2305-0005A

\*UHMW-PE - Ultra High Molecular Weight Polyethylene  
\*\*ITB PTFE - Improved PTFE Blend



42-36-01357

## LAMPS

### Jasco

		OEM #
<b>42-32-02841</b>	DoubleLife Deuterium Lamp, 870, 875	5330-0097
<b>42-32-02842</b>	DoubleLife Deuterium Lamp, UV-1570, -1575, -2070, -2075, 975 B/C Series	5330-0091



42-36-01355



42-34-01354



42-32-02842



## OPTI-MAX® CHECK VALVES

**LKB 2150, 2248, 2500** 

		OEM #
<b>32-46-00782</b>	OPTI-MAX Inlet Housing & Cartridge	80-1035-19
<b>32-46-00787</b>	OPTI-MAX Outlet Housing & Cartridge	2150-300
<b>10-46-02004</b>	OPTI-MAX Replacement Cartridges, 1/16" Ball, 2/Pk	

OPTIONS: Stainless steel/ceramic OPTI-MAX Cartridges are listed above.  
For other options, please see page 50.



## SEALS &amp; PISTONS

**LKB 2150, 2248, 2500**

		OEM #
<b>32-36-01303</b>	ITB PTFE** Piston Seal, with Back-Up Ring	80-1037-39
<b>32-36-01304</b>	ITB PTFE** Piston Seal, with Back-Up Rings, 10/Pk	
<b>32-34-00771</b>	Sapphire Piston, 2150	80-1035-52

\*\*ITB PTFE - Improved PTFE Blend



## LAMPS

**LKB/Amersham/Pharmacia**

<b>32-32-02821</b>	Deuterium Lamp, LKB Ultraspec I, II, III, Plus, 4050, 4051, 4054, 2141, 2151
--------------------	---

## OPTI-MAX® CHECK VALVES

**Series 4, Model 250, 200\*, 400, 410, 620, Integral 4000\***

		OEM #
<b>33-56-00830</b>	OPTI-MAX Inlet Housing & Cartridge	0254-0177
<b>33-56-00835</b>	OPTI-MAX Outlet Housing & Cartridge	0254-0197
<b>10-56-02004</b>	OPTI-MAX Replacement Cartridges, 1/8" Ball, 2/Pk	

OPTIONS: Stainless steel/ceramic OPTI-MAX Cartridges are listed above. For other options, please see page 50.

\*These pumps have an intermediate check valve which is identical to the inlet check valve. To order a replacement intermediate valve, use the OPTI-MAX inlet part number.

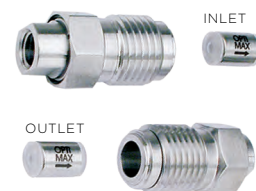

Model 250, Series 4, 200, 400, 410, 620, Integral 4000

## SEALS & PISTONS

		OEM #
<b>Model 200, 250, 410, 620, Integral 4000 (Mfd. After 12/89)</b>		
<b>33-34-00798</b>	Piston (High Pressure)	N260-0124



33-34-00798

		OEM #
<b>Series 1, 2, 3, 3B, 10, Model 200, 250, 400, 410, 620, Integral 4000</b>		
<b>33-36-01301</b>	OPTI-SEAL UHMW-PE* Piston Seal (High Pressure)	0990-7324



33-36-01301

<b>33-36-01302</b>	OPTI-SEAL UHMW-PE* Piston Seal (High Pressure), 10/Pk	
--------------------	--	--

		OEM #
<b>Series 4, Model 400, 410, 620, Integral 4000</b>		
<b>33-36-00804</b>	OPTI-SEAL UHMW-PE* Piston Seal (Low Pressure)	0990-7330



33-36-00804

<b>33-36-00805</b>	OPTI-SEAL UHMW-PE* Piston Seal (Low Pressure), 10/Pk	
--------------------	---	--

		OEM #
<b>Series 100</b>		
<b>33-36-00806</b>	OPTI-SEAL UHMW-PE* Piston Seal	N260-0108



33-36-00806

<b>33-36-00807</b>	OPTI-SEAL UHMW-PE* Piston Seal , 10/Pk	
<b>33-36-00808</b>	ITB PTFE** Piston Seal	N260-0109

<b>33-36-00809</b>	ITB PTFE** Piston Seal, 10/Pk	
--------------------	-------------------------------	--

\*UHMW-PE - Ultra High Molecular Weight Polyethylene

\*\*ITB PTFE - Improved PTFE Blend



33-36-00808

## LAMPS

		OEM #
<b>PerkinElmer</b>		
<b>33-32-03117</b>	Deuterium Lamp, 200 UV/Vis	N292-0149
<b>33-32-03114</b>	DoubleLife Deuterium Lamp, Series 200 DAD	N292-2046



33-32-03114

## SHIMADZU

## OPTI-MAX® CHECK VALVES

**LC-30**

Part Number	Description	Shimadzu #
<b>34-76-05135</b>	OPTI-MAX Inlet Housing & Cartridge	228-52964-95
<b>10-76-02004</b>	OPTI-MAX Replacement Cartridges (for Inlet), 1/16" Ball, 2/Pk	
<b>34-86-05139</b>	OPTI-MAX Outlet Housing & Cartridge	228-53334-96
<b>10-86-02004</b>	OPTI-MAX Replacement Cartridges (for Outlet), 1/16" Double Ball, 2/Pk	

**LC-30ADSF, i-Series, LC-2040/C, LC-2030/C  
LC-20ABXR, ADXR**

Part Number	Description	Shimadzu #
<b>34-86-02644</b>	OPTI-MAX Inlet Housing & Cartridge	228-48249-91 228-48249-96
<b>34-86-00893</b>	OPTI-MAX Outlet Housing & Cartridge	228-45705-91
<b>10-86-02004</b>	OPTI-MAX Replacement Cartridges 1/16" Ball, 2/Pk	



LC-10AT, LC-10ATVP

**LC-10AT, ATVP**

Part Number	Description	Shimadzu #
<b>34-46-01983</b>	OPTI-MAX Inlet Housing & Cartridge	228-32166-91 228-39093-92
<b>34-46-00893</b>	OPTI-MAX Outlet Housing & Cartridge	228-32531-92 228-34976-91
<b>10-46-02004</b>	OPTI-MAX Replacement Cartridges, 1/16" Ball, 2/Pk	



LC-10ADVP

**LC-20AB, AD, ADsp, ADnano, AT, LC-10ADVP, 2010,  
GPC-20 & 50 (100µL Head), ESA 582 & 584**

Part Number	Description	ESA#	Shimadzu #
<b>34-46-02644</b>	OPTI-MAX Inlet Housing & Cartridge	70-4056	228-39093-92 228-45704-91
<b>34-46-00893</b>	OPTI-MAX Outlet Housing & Cartridge	70-4057	228-34976-91 228-45705-91 228-37147-93
<b>10-46-02004</b>	OPTI-MAX Replacement Cartridges, 1/16" Ball, 2/Pk		



LC-10AD, LC-600, LC-9A

**LC-10AD, 9A, 600 (also ESA Model 580)**

Part Number	Description	ESA#	Shimadzu #
<b>34-46-00885</b>	OPTI-MAX Inlet Housing & Cartridge	70-0734	228-18522-91 228-33492-91
<b>34-46-00893</b>	OPTI-MAX Outlet Housing & Cartridge	70-0735	228-18522-92 228-32531-92
<b>10-46-02004</b>	OPTI-MAX Replacement Cartridges, 1/16" Ball, 2/Pk		



LC-10AS, LC-6A

**LC-10AS, 6A**

Part Number	Description	Shimadzu #
<b>34-56-00902</b>	OPTI-MAX Inlet Housing & Cartridge	228-12353-91
<b>34-56-00907</b>	OPTI-MAX Outlet Housing & Cartridge	228-09054-93
<b>10-56-02004</b>	OPTI-MAX Replacement Cartridges, 1/8" Ball, 2/Pk	



LC-8A

**LC-20AP, 8A**

Part Number	Description	Shimadzu #
<b>34-66-02112</b>	OPTI-MAX Inlet Housing & Cartridge	228-20256-91
<b>10-66-02005</b>	OPTI-MAX Replacement Cartridges (for LC-8A Inlet), 3/16" Ball, 2/Pk	
<b>34-56-00907</b>	OPTI-MAX Outlet Housing & Cartridge	228-09054-93 228-50955-41
<b>10-56-02004</b>	OPTI-MAX Replacement Cartridges (for LC-8A Outlet), 1/8" Ball, 2/Pk	

OPTIONS: Stainless steel/ceramic OPTI-MAX cartridges are listed above.  
For other options, please see page 50.



## SEALS & PISTONS

### LC-20ABXR, ADXR, LC-20AB, AD, AT, LC-2010, LC-10ADVP, ESA 582 & 584

	ESA#	Shimadzu #
<b>34-36-00855</b> OPTI-SEAL UHMW-PE* Piston Seal		228-32628-00 228-18745-00 228-35146-00
<b>34-36-00856</b> OPTI-SEAL UHMW-PE* Piston Seal, 10/Pk		
<b>34-36-04711</b> ITB PTFE** Piston Seal		228-18745-00 228-35146-00
<b>34-36-04712</b> ITB PTFE** Piston Seal, 10/Pk		
<b>34-34-02645</b> Sapphire Piston for LC-10ADVP, 2010, 20AD (can be used for LC-10AT if user has Plunger Holder P/N 34-34-01991)	70-4052	228-35601-91 228-35601-92 228-35601-93



34-36-00855



34-34-02645



34-36-00865



34-36-00863

### LC-20AT, 10AT, 10ATVP, 10AS, 7A, 6A, SIL-10ADVP, GFP

	Shimadzu #
<b>34-36-00865</b> OPTI-SEAL UHMW-PE* Piston Seal	228-11999-00 228-21975-00 228-35145-00
<b>34-36-00866</b> OPTI-SEAL UHMW-PE* Piston Seal, 10/Pk	
<b>34-36-00863</b> ITB PTFE** Piston Seal	228-11999-00 228-21975-00 228-35145-00
<b>34-36-00864</b> ITB PTFE** Piston Seal, 10/Pk	
<b>34-34-01345</b> Sapphire Piston for LC-10AS	228-17019-93
<b>34-34-02650</b> Sapphire Piston for LC-10ATVP	228-35009-92



34-34-01345



34-34-02650

Piston Wash Users: The above seals can also be used as Back Seals (OEM# 228-28499-00)

### LC-10AD, 9A, 600, ESA 580

	Shimadzu #
<b>34-36-00855</b> OPTI-SEAL UHMW-PE* Piston Seal	228-18745-00 228-35146-00
<b>34-36-00856</b> OPTI-SEAL UHMW-PE* Piston Seal, 10/Pk	
<b>34-36-00857</b> UHMW-PE* Elastomer Energized Seal	228-18745-00 228-35146-00
<b>34-36-00858</b> UHMW-PE* Elastomer Energized Seal, 10/Pk	

\*UHMW-PE - Ultra High Molecular Weight Polyethylene

\*\*ITB PTFE - Improved PTFE Blend



34-36-00857



34-04-03881

## FILTRATION

### LC-10AD, 10AS, 10AT, 9A, 6A, 6AD, 6AEF, 610

	Shimadzu #
<b>34-04-03881</b> In-Line Filter Assembly	228-12642-93

## LAMPS

	Shimadzu #
<b>34-32-02837</b> DoubleLife Deuterium Lamp, SPD-10A, -10AV, -M10A, -10AS, -10AVP, -M10AVP, -20AV	228-34016-02
<b>34-32-03102</b> DoubleLife Deuterium Lamp, LC 2010, LC- 2010HT	228-37401-00



Shimadzu  
34-32-02837

## THERMO: LDC / MILTON ROY

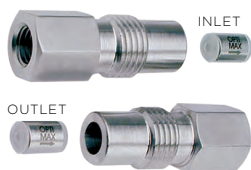

OPTI-MAX for LDC



31-36-00806



31-36-00808



31-36-00745



31-34-00738



31-32-01295

## OPTI-MAX® CHECK VALVES

**All Analytical***(including Constametric, Minimetric, Minipump, Mini Duplex)*

		OEM #
<b>31-56-00759</b>	OPTI-MAX Inlet Housing & Cartridge	900947001
<b>31-56-00764</b>	OPTI-MAX Outlet Housing & Cartridge	900947002
<b>10-56-02004</b>	OPTI-MAX Replacement Cartridges, 1/8" Ball, 2/Pk	

OPTIONS: Stainless steel/ceramic OPTI-MAX Cartridges are listed above.

For other options, please see page 50.

## SEALS &amp; PISTONS

**All Analytical***(including Constametric, Minimetric, Minipump, Mini Duplex)*

		OEM #
<b>31-36-00806</b>	OPTI-SEAL UHMW-PE* Piston Seal	206234
<b>31-36-00807</b>	OPTI-SEAL UHMW-PE* Piston Seal, 10/Pk	
<b>31-36-00808</b>	ITB PTFE** Piston Seal, Black	206129001
<b>31-36-00809</b>	ITB PTFE** Piston Seal, Black, 10/Pk	
<b>31-36-00745</b>	UHMW-PE* Piston Seal, Gold	206234
<b>31-36-00746</b>	UHMW-PE* Piston Seal, Gold, 10/Pk	
<b>31-34-00738</b>	Sapphire Piston	801306

\*UHMW-PE - Ultra High Molecular Weight Polyethylene

\*\*ITB PTFE - Improved PTFE Blend

## LAMPS

**LDC/Milton Roy**

		OEM #
<b>31-32-01295</b>	Deuterium Lamp, 3000 and 4000 Series, Spectromonitor I-II-III-D	108035

# THERMO: SPECTRA-PHYSICS

## OPTI-MAX® CHECK VALVES

### 8700, 8800, 8810, IsoChrom, P-Series

		OEM #
<b>35-56-00956</b>	OPTI-MAX Inlet Housing & Cartridge	A3495-010
<b>35-56-00961</b>	OPTI-MAX Outlet Housing & Cartridge	A3490-010
<b>35-56-00952</b>	OPTI-MAX Transducer Housing & Cartridge	A3990-010
<b>10-56-02004</b>	OPTI-MAX Replacement Cartridges, 1/8" Ball, 2/Pk	

OPTIONS: Stainless steel/ceramic OPTI-MAX Cartridges are listed above.  
For other options, please see page 50.

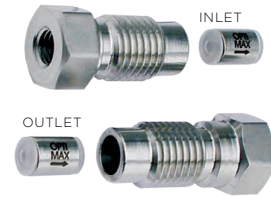

OPTI-MAX for Spectra-Physics

## SEALS & PISTONS

### 8800, 8810, IsoChrom, P-Series

		OEM #
<b>35-36-00930</b>	OPTI-SEAL UHMW-PE* Piston Seal	A2962-010
<b>35-36-00931</b>	OPTI-SEAL UHMW-PE* Piston Seal, 10/Pk	
<b>35-36-00938</b>	ITB PTFE** Piston Seal	A2962-010
<b>35-36-00939</b>	ITB PTFE** Piston Seal, 10/Pk	
<b>35-36-00916</b>	Back-Up Seal, PCTFE	A4848-010
<b>35-36-00917</b>	Back-Up Seal, PCTFE, 10/Pk	
<b>35-36-00918</b>	OPTI-SEAL UHMW-PE* Flush Seal	A2963-010
<b>35-36-00919</b>	OPTI-SEAL UHMW-PE* Flush Seal, 10/Pk	
<b>35-36-00920</b>	ITB PTFE** Flush Seal	A2963-010
<b>35-36-00921</b>	ITB PTFE** Flush Seal, 10/Pk	
<b>35-34-00915</b>	Sapphire Piston	A3102-010

### 8700, 8700XR, 8750

		OEM #
<b>35-36-00934</b>	OPTI-SEAL UHMW-PE* Piston Seal	A1703-020
<b>35-36-00935</b>	OPTI-SEAL UHMW-PE* Piston Seal, 10/Pk	

\*UHMW-PE - Ultra High Molecular Weight Polyethylene

\*\*ITB PTFE - Improved PTFE Blend

## LAMPS

### Spectra-Physics

		OEM #
<b>35-32-01333</b>	Deuterium Lamp, Spectra-Physics Focus, 100, 200, UV-100, -150, -200, -100, 2000, 3000, CE Series	9551-0023



35-36-00930



35-36-00938



35-36-00916



35-36-00918



35-36-00920



35-34-00915



35-36-00934

# VARIAN, GILSON / RAININ

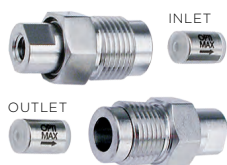

2010 for Varian

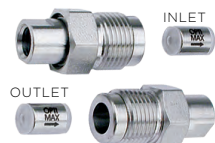

2510 for Varian



38-38-04790  
for Varian



38-56-01067  
OPTI-MAX for Varian



26-36-00632



26-36-00630



26-36-00634



26-36-00636



26-34-00625

## OPTI-MAX® CHECK VALVES

### 5, 10 & 25mL S/SC Heads

(Gilson, Rainin, ProStar 210/215, HP, HPX, HPXL, SD 200/300)

Part #	Description	OEM #
26-56-00638	OPTI-MAX Inlet Housing & Cartridge	R007101616, R007101678
26-56-00647	OPTI-MAX Outlet Housing & Cartridge	R007101617, R007101679
10-56-02004	OPTI-MAX Replacement Cartridges, 1/8" Ball, 2/Pk	

### 2010 ↻

Part #	Description	OEM #
38-56-01038	OPTI-MAX Inlet Housing & Cartridge	00-997261-09
38-56-01043	OPTI-MAX Outlet Housing & Cartridge	00-997261-10
10-56-02004	OPTI-MAX Replacement Cartridges, 1/8" Ball, 2/Pk	

### 2510 ↻

Part #	Description	OEM #
38-56-01544	OPTI-MAX Inlet Housing & Cartridge	00-997554-19
38-56-01546	OPTI-MAX Outlet Housing & Cartridge	00-997554-18
10-56-02004	OPTI-MAX Replacement Cartridges, 1/8" Ball, 2/Pk	

### 9000 Star, 9010, 9012, ProStar 220, 230, 240 ↻

Part #	Description	OEM #
38-38-04790	Inlet Check Valve Assembly Includes Installation kit	03-919085-90
38-56-01067	OPTI-MAX Outlet Housing & Cartridge	03-919465-90
10-56-02004	OPTI-MAX Replacement Cartridges, 1/8" Ball, 2/Pk	

OPTIONS: Stainless steel/ceramic OPTI-MAX Cartridges are listed above.  
For other options, please see page 50.

## SEALS & PISTONS

### 10mL S/SC Heads (Gilson, Rainin, HP, HPX, HPXL, SD 200/300)

Part #	Description	OEM #
26-36-00632	OPTI-SEAL UHMW-PE* Piston Seal	5463125895, R007101447
26-36-00633	OPTI-SEAL UHMW-PE* Piston Seal, 10/Pk	
26-36-00630	ITB PTFE** Piston Seal	5463125095, R007101636
26-36-00631	ITB PTFE** Piston Seal, 10/Pk	

### 5mL S/SC Heads (Gilson, Rainin, HP, HPX, HPXL, SD 200/300)

Part #	Description	OEM #
26-36-00634	OPTI-SEAL UHMW-PE* Piston Seal	5463088863, R007101634
26-36-00635	OPTI-SEAL UHMW-PE* Piston Seal, 10/Pk	
26-36-00636	ITB PTFE** Piston Seal	5463088063, R007101633
26-36-00637	ITB PTFE** Piston Seal, 10/Pk	
26-34-00625	Piston, 5mL SC Head	3650008, R007101657

### ProStar 210/215 (10mL Heads)

Part #	Description	OEM #
38-36-00632	OPTI-SEAL UHMW-PE* Piston Seal	R007101447
38-36-00633	OPTI-SEAL UHMW-PE* Piston Seal, 10/Pk	

# VARIAN, GILSON / RAININ

## ProStar 210/215 (10mL Heads) (continued)

		OEM #
<b>38-36-00630</b>	ITB PTFE** Piston Seal	R007101636
<b>38-36-00631</b>	ITB PTFE** Piston Seal, 10/Pack	



38-36-01000

## ProStar 210/215 (5mL Heads)

		OEM #
<b>38-36-00634</b>	OPTI-SEAL UHMW-PE* Piston Seal	R007101634
<b>38-36-00635</b>	OPTI-SEAL UHMW-PE* Piston Seal, 10/Pk	
<b>38-36-00636</b>	ITB PTFE** Piston Seal	R007101633
<b>38-36-00637</b>	ITB PTFE** Piston Seal, 10/Pk	
<b>38-34-00625</b>	Sapphire Piston, 5mL Head	R007101657



38-36-01002

## 2010, 2510

		OEM #
<b>38-36-01000</b>	OPTI-SEAL UHMW-PE* Piston Seal	00-997261-37
<b>38-36-01001</b>	OPTI-SEAL UHMW-PE* Piston Seal, 10/Pk	
<b>38-36-01002</b>	ITB PTFE** Piston Seal	00-997261-37
<b>38-36-01003</b>	ITB PTFE** Piston Seal, 10/Pk	
<b>38-34-00999</b>	Sapphire Piston	00-997261-08



38-34-00999

## 9000 Star, 9010, 9012, 9020, 220, 230, 240

		OEM #
<b>38-36-01555</b>	OPTI-SEAL UHMW-PE* Piston Seal	03-919397-00
<b>38-36-01556</b>	OPTI-SEAL UHMW-PE* Piston Seal, 10/Pk	
<b>38-36-01553</b>	ITB PTFE** Piston Seal	03-919397-00
<b>38-36-01554</b>	ITB PTFE** Piston Seal, 10/Pk	
<b>38-34-01342</b>	Sapphire Piston	03-919180-00 03-919102-90



38-36-01555



38-36-01553

\*UHMW-PE - Ultra High Molecular Weight Polyethylene

\*\*ITB PTFE - Improved PTFE Blend

## LAMPS

### Gilson / Rainin Models

		OEM #
<b>26-32-03671</b>	Deuterium Lamp, Gilson/Rainin 115, 116, 117, 118, 119, 151, 152, 155, 156	100326
<b>26-32-03069</b>	Deuterium Lamp, Gilson/Rainin 170 DAD	2140-0590

### Varian Models

		OEM #
<b>38-32-01637</b>	Deuterium Lamp, Varian 2050, 2550, 5500	
<b>38-32-03673</b>	Deuterium Lamp, Varian ProStar 330 DAD	0393570502
<b>38-32-02831</b>	DoubleLife Deuterium Lamp, Vista 5000-5500, UV-50, -100, -200, -9050	0391615691
<b>38-32-02081</b>	Deuterium Lamp, Varian ProStar 340, 345, U-VC, UV-DII, UV-M, UVDII, UV	R000088515
<b>38-32-03654</b>	DoubleLife Deuterium Lamp, Varian ProStar 325, 335	110715400
<b>38-32-04022</b>	Xenon Lamp, Varian ProStar 363	392613102



38-34-01342



38-32-01637

## WATERS

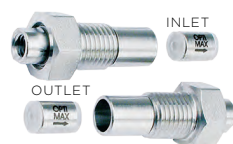

2690/Alliance



100µL Head Systems

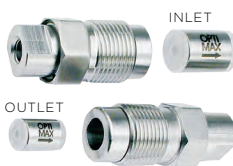

225µL Head Systems

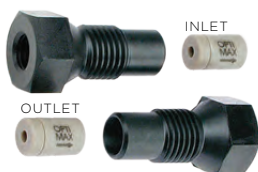
400µL, 500µL & 900µL  
Heads/Systems

625/626

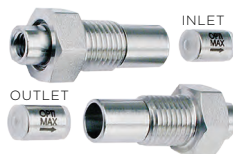

616

## OPTI-MAX® CHECK VALVES

**2690, 2695, 2790, 2795, Alliance\***

		OEM #
<b>39-46-01949</b>	OPTI-MAX Inlet Housing & Cartridge	WAT027112, 700002332
<b>10-46-02004</b>	OPTI-MAX Replacement Cartridges, 1/16" Ball, 2/Pk	WAT270941, 700002761

\*2690/Alliance Systems have inlet check valves only - outlets are not required.

**100µL Head Systems**

(M45/45G, M501, 510, 515, 590,

600/600E, 610, 6K/6KA, 1515, 1525, LC Module 1)

		OEM #
<b>39-56-01251</b>	OPTI-MAX Inlet Housing & Cartridge	WAT033679, 700000253
<b>39-56-01256</b>	OPTI-MAX Outlet Housing & Cartridge	700000253
<b>10-56-02004</b>	OPTI-MAX Replacement Cartridges, 1/8" Ball, 2/Pk	700000254, 700002399

**225µL Head (#3) Systems**

(510, 515, 590, 600/600E, 610, 650, 6K/6KA)

		OEM #
<b>39-66-01262</b>	OPTI-MAX Inlet Housing & Cartridge	WAT033679, WAT060307
<b>10-66-02005</b>	OPTI-MAX Replacement Cartridges, 3/16" Ball, 2/Pk	
<b>39-56-01256</b>	OPTI-MAX Outlet Housing & Cartridge	WAT025216
<b>10-56-02004</b>	OPTI-MAX Replacement Cartridges, 1/8" Ball, 2/Pk	700000254, 700002399

**400µL (#4), 500µL (#5), & 900µL (#6) Heads**

(Delta Prep 3000, 600/600E, 650)

		OEM #
<b>39-66-01267</b>	OPTI-MAX Outlet Housing & Cartridge	WAT033326, WAT033325
<b>10-66-02005</b>	OPTI-MAX Replacement Cartridges, 3/16" Ball, 2/Pk	

**625/626**

		OEM #
<b>39-48-01907</b>	OPTI-MAX Inlet Housing & Cartridge, PEEK	WAT030541
<b>39-48-01909</b>	OPTI-MAX Outlet Housing & Cartridge, PEEK	WAT030543
<b>10-48-02004</b>	OPTI-MAX Replacement Cartridges, 1/16" Ball, 2/Pk	WAT024120

**616, 1525µ (Micro)**

		OEM #
<b>39-46-01949</b>	OPTI-MAX Inlet Housing & Cartridge	WAT055845
<b>39-46-01950</b>	OPTI-MAX Outlet Housing & Cartridge	WAT055845
<b>10-46-02004</b>	OPTI-MAX Replacement Cartridges, 1/16" Ball, 2/Pk	WAT270941, 700002761

OPTIONS: Stainless steel/ceramic OPTI-MAX cartridges are listed above (except for the 625/626, which requires PEEK housings and cartridges). For other options, please see page 50.

## SEALS & PISTONS

**Alliance, 2690, 2695, 2790, 2795, 2690D, 2695D, 2796, GPC, V2000**

		OEM #
<b>39-36-02596</b>	OPTI-SEAL UHMW-PE* Piston Seal	WAT270938
<b>39-36-02603</b>	OPTI-SEAL UHMW-PE* Piston Seal, 2/Pk	WAT270938
<b>39-36-02597</b>	OPTI-SEAL UHMW-PE* Piston Seal, 10/Pk	
<b>39-36-02855</b>	Face Seals Replacement Kit, 4/Pk	WAT270939
<b>39-36-02856</b>	Seal Wash Face Seal	WAT271017
<b>39-36-02858</b>	Seal Wash Tube Seals Replacement Kit, 4/Pk	WAT270940
<b>39-36-02860</b>	Seal Wash, Piston Seal, Replacement Kit, 2/Pk	WAT271018
<b>39-34-02180</b>	Sapphire Piston	WAT270959

### 100µL Head Systems

**(M45/45G, M501, 510, 590, 600/600E, 610, 6K/6KA, 1515, 1525, 515, LC Module 1)**

		OEM #
<b>39-36-01305</b>	OPTI-SEAL UHMW-PE* Piston Seal	WAT022934 WAT022946
<b>39-36-01306</b>	OPTI-SEAL UHMW-PE* Piston Seal, 10/Pk	
<b>39-36-01206</b>	ITB PTFE** Piston Seal, Black	WAT026613
<b>39-36-01207</b>	ITB PTFE** Piston Seal, Black, 10/Pk	
<b>39-34-01188</b>	Piston, 510, 590, 600/600E, 610, 6K/6KA	WAT025656
<b>39-34-01191</b>	Piston, M45/45G, M501	WAT026524

### 225µL Head (#3) Extended Flow Systems

**(510, 590, 600/600E, 610, 650, 6K/6KA, 515, 1525 EF, LC Module 1)**

		OEM #
<b>39-36-01216</b>	OPTI-SEAL UHMW-PE* Piston Seal	WAT026644 700002282
<b>39-36-01217</b>	OPTI-SEAL UHMW-PE* Piston Seal, 10/Pk	
<b>39-36-01214</b>	ITB PTFE** Piston Seal	WAT026644 700002282
<b>39-36-01215</b>	ITB PTFE** Piston Seal, 10/Pk	
<b>39-34-01193</b>	Piston	WAT060304

### 616, 625/626

		OEM #
<b>39-36-02124</b>	OPTI-SEAL UHMW-PE* Piston Seal	
<b>39-36-02228</b>	OPTI-SEAL UHMW-PE* Piston Seal, 10/Pk	
<b>39-36-02127</b>	ITB PTFE** Piston Seal	WAT031790
<b>39-36-02229</b>	ITB PTFE** Piston Seal, 10/Pk	

\*UHMW-PE - Ultra High Molecular Weight Polyethylene

\*\*ITB PTFE - Improved PTFE Blend



## WATERS (CONTINUED)



Waters  
39-32-02825



39-04-03524  
Filter Insert Assembly



10-04-03151  
Solvent Filter



39-31-01147  
Needle with Nut & Ferrule



39-31-01171  
Priming Syringe

## LAMPS

**Waters**

		<b>OEM #</b>
<b>39-32-01175</b>	Mercury Lamp, Waters 440, 441	WAT097323
<b>39-32-01179</b>	Deuterium Lamp, Waters 484	WAT080357
<b>39-32-01294</b>	Deuterium Lamp, Waters 450	WAT098946
<b>39-32-01295</b>	Deuterium Lamp, Waters 480, 481, 481AZ	WAT099499
<b>39-32-02823</b>	Deuterium Lamp, Waters 486	WAT080678
<b>39-32-02825</b>	ACQUITY, CapLC 2487, nanoACQUITY Deuterium Lamp, Waters 2487, 2488	WAS081142
<b>39-32-02835</b>	DoubleLife Deuterium Lamp, Waters 996, 2996, PDA	WAT052586
<b>39-32-02688</b>	Xenon Lamp, Waters 490E	WAT046660

## FILTRATION

**2690/2695, 2790/2795, 600**

		<b>OEM #</b>
<b>39-04-03524</b>	2µm Filter Insert Assembly, In-Line	WAT088084
<b>10-04-03151</b>	Solvent Filter, 1/8", 10µm, 4/Pk	WAT025531

For additional filtration configurations, see page 23 for solvent reservoir filters.

## INLET MANIFOLD PARTS &amp; PRIMING ACCESSORIES

<b>Part No</b>	<b>Description</b>	<b>OEM #</b>
<b>39-31-01171</b>	Optimize Safety Syringe (for pump priming)	WAT027629
<b>39-31-01147</b>	Needle with Nut & Ferrule	WAT025559
<b>39-31-01151</b>	Priming Syringe Kit Includes Priming Syringe, Needle, Nut & Ferrule	



## CUSTOM INNOVATION

---

Partner with Optimize to bring your UHPLC concepts to reality - no challenge is too small or too large. We offer state-of-the-art manufacturing and design in Oregon, USA. Highly experienced engineers, design specialists, chemists, and machinists have exactly what it takes to bring your ideas to fruition.

Please contact us to incorporate Optimize Technologies' patented features into your custom applications. Some of the key industries we serve include Chromatography, Mass Spectrometry, Pharmaceutical Research, Clinical, Environmental, Petrochemical, Defense and other High Pressure Fluidics. We look forward to helping you optimize your laboratory.

---

- Need a check valve rated to 30,000+ psi (2,100+ bar)?
- Would a quick-connect UHPLC column improve productivity?
- Interested in upgrading your current HPLC system to perform at UHPLC pressures?

THE BEST WAY TO  
PREDICT THE FUTURE  
IS TO INVENT IT.

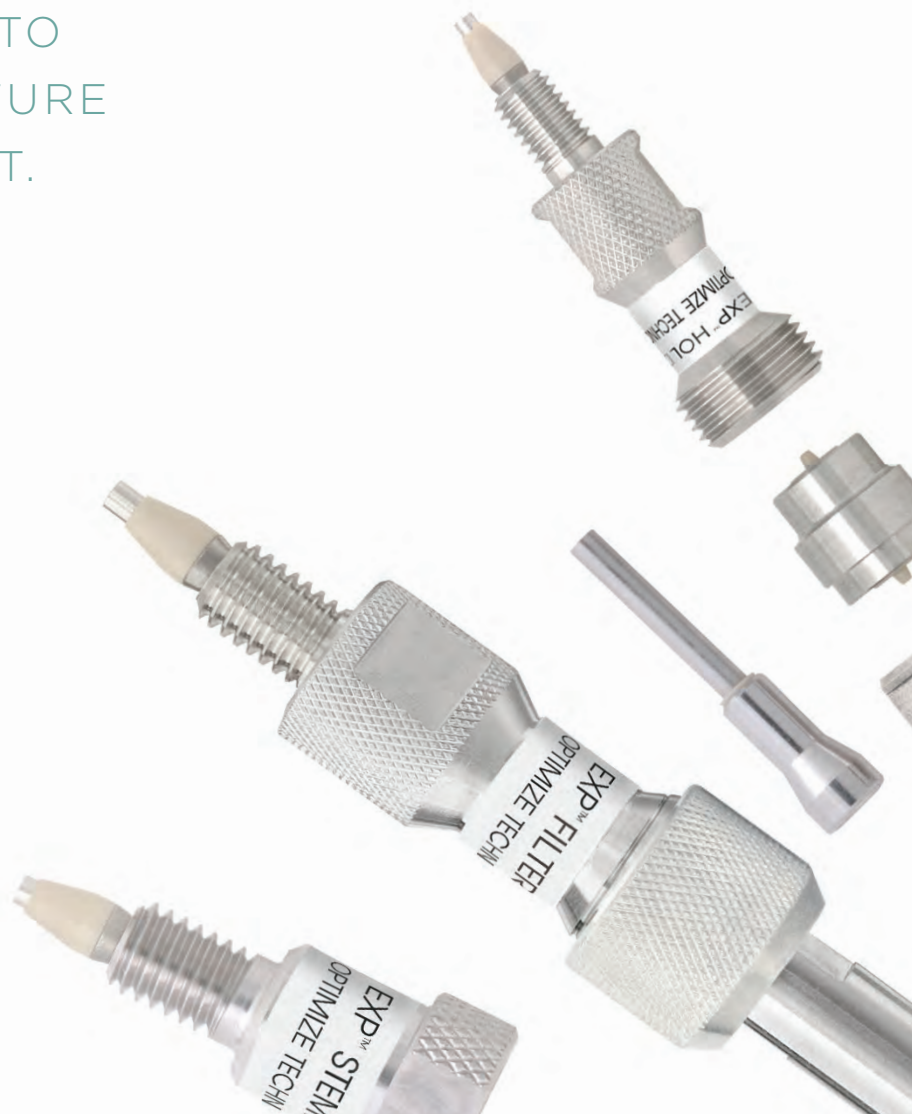

# OPTIMIZE TRAPPING GUIDE

A PRIMER FOR THE LC OR LC/MS  
TECHNIQUE OF OFF-LINE AND  
ON-LINE TRAPPING.



## INTRODUCTION

---

Sample matrix components such as salts, detergents and contaminants present problems for mass spec analysis. Trapping is a chromatography technique that allows for the concentration or purification of a sample. A trap cartridge is a packed column bed loaded with a material to create desirable conditions for separating the target compound from the rest of the sample matrix. By selecting a packing material that has a strong affinity for the target compound, the analyte is retained in the trap while the rest of the sample matrix flows through. Alternately, a material can be selected which has no affinity for the target compound but that binds other unwanted matrix components.

Trap columns are uni-directional or bi-directional and are used either on-line or off-line for sample pre-concentration and clean-up. Trap column bed materials need not be similar to the primary LC column bed materials and can be selected based on sample clean-up needs. Desirable characteristics of a trap include low back pressure, bi-directional flow, robust bed, ability to regenerate the packed bed and low swept volume.

## TRAP COLUMNS VS. GUARD COLUMNS

---

Choosing between traps and guard columns is determined by the application. A guard column is a short, disposable pre-column which removes particulates and contaminants that would otherwise shorten the life of the expensive LC column. A guard column protects the primary column. When selecting a guard column, a bonded phase similar to the primary column should be used.

Optimize Technologies offers several trapping options for LC applications:

- OPTI-TRAP™ - suitable for medium pressure manual and on-line applications (1,500 psi)
- OPTI-LYNX™ - a quarter-turn quick-connect system for HPLC applications (6,000 psi)
- EXP® for UHPLC applications up to 20,000+ psi

Trap columns are offered in a range of bed volumes from 0.12 $\mu$ L to 100 $\mu$ L and can be loaded with a variety of packing materials found in the Trap Column section (pages 29-38). For additional packing materials, please contact Optimize directly.

Trapping is a valuable technique for handling a variety of processes such as sample clean-up, purification, pre-concentration, desalting and detergent removal. In order to retain a target compound within a trap cartridge while flushing the sample matrix and any unwanted contaminants to waste, a packed bed with an affinity for the target compound is used. Alternatively, a packed bed with no affinity for the target compound may be used in order to keep the desired analyte unretained while having the undesired contaminant bound to the stationary phase.

In cases where samples are undesirably dilute, it is possible to increase the concentration of the target analyte in a sample either off-line or on-line. Using a trap cartridge allows the reduction of volume of a sample matrix while concentrating the analyte.

## TRAP CARTRIDGES FOR SAMPLE PRE-CONCENTRATION

### OFF-LINE SAMPLE PRE-CONCENTRATION

Using a syringe or a small pump along with a trap cartridge that has an affinity for the target analyte, a sample matrix is driven across the trap bed at a flow rate within the recommended range. A slower flow rate is generally considered better.

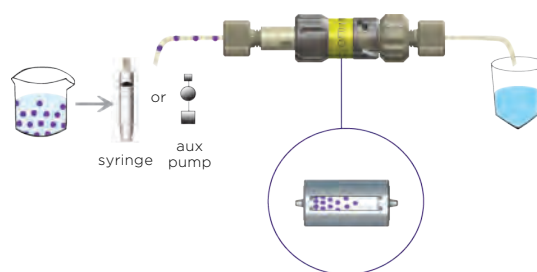

The sample matrix will be sent to waste while the target analyte is retained within the trap. The target analyte is now able to be eluted in a small volume of stronger solvent.

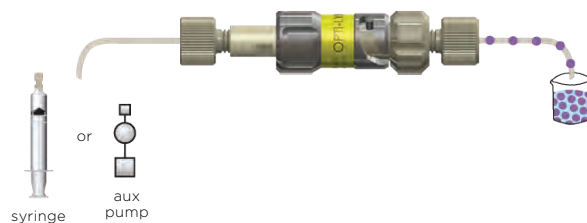

A quick rinse step prior to the elution step is advantageous if salts are present in the sample matrix. Elution takes place either by manual delivery of solvent or by installing the trap cartridge into a holder in-line upstream from an analytical column or within an injection loop.

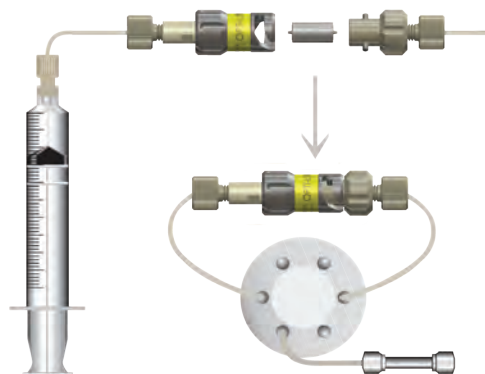

# TRAP CARTRIDGES FOR SAMPLE PRE-CONCENTRATION

## OFF-LINE SAMPLE PRE-CONCENTRATION

Pre-concentration can be automated by placing a trap cartridge in-line in the loop of an injection or switching valve. This setup allows two different sources to push solvents through the trap depending on the position of the valve.

The sample solution is pushed through the trap bed by an auxiliary pump during the loading phase. After the sample matrix is flushed to waste, it may be beneficial to wash the trap bed with a salt-free solution, ensuring that any buffer salts are rinsed away.

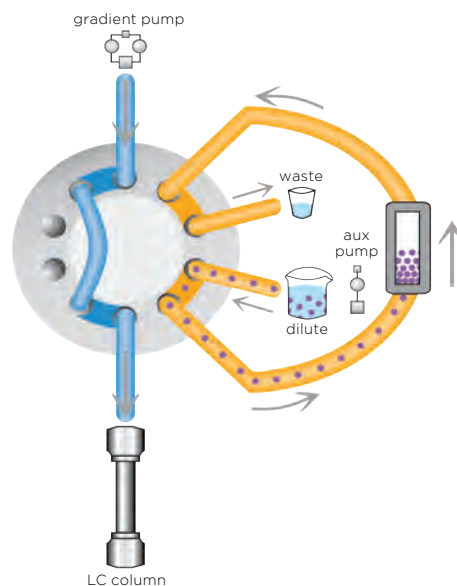

Additional samples may be collected by repeating the sample-loading step with a flushing solvent in order to ensure that any additional sample remaining in the tubing makes it across the packing material during elution.

Using a small volume of suitably strong organic solvent, the concentrated sample can now be eluted.

Eluent can be sent directly to a mass spectrometer or to an analytical column for further separation. If the analyte contains a complex mixture of proteins and peptides, it may be desirable to follow the pre-concentration step with a two-dimensional LC configuration.

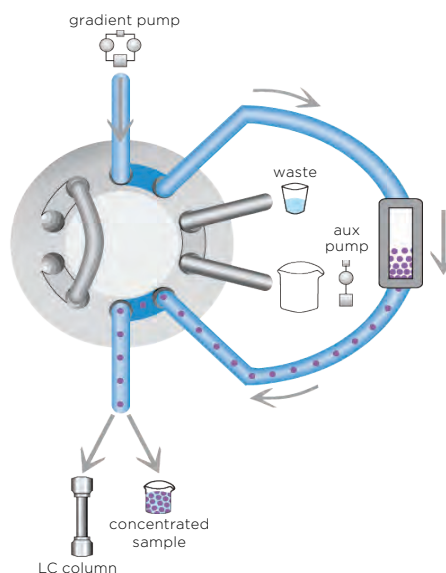

# DETERGENT REMOVAL VIA TRAPPING

## DETERGENT REMOVAL

Detergents may be present as a result of SDS PAGE analysis or as additions in order to help solubilize a sample. Prior to LC or LCMS analysis, these detergents must be removed.

Many off-line detergent removal methods are time consuming and may result in a significant loss of sample. An on-line trap provides a more convenient and efficient method for detergent removal.

The type of detergent present in a protein sample affects the method of removal. Generally, there are three types of detergents that may be present in a sample: ionic, zwitterionic and non-ionic. Regardless of the method used, the idea is the same: trap the protein, wash detergent to waste and elute the protein or trap the detergent while allowing the protein to pass through.

## SDS & IONIC DETERGENT REMOVAL

Ionic detergents such as SDS (sodium dodecyl sulfate) may be removed using a simple ion exchange trap. The packing material used in the trap must have an affinity for the type of charge on the polar head group of the detergent. Anionic detergents require the use of a strong anion exchange (SAX) phase such as a quaternary amine. Alternatively, cationic detergents require use of a strong cation exchange (SCX) phase such as benzenesulfonic acid.

SDS removal is accomplished by using a polymer-based anion exchanger. Mobile phase with a pH of 4.4 or less is used in order to provide conditions where the trap has a maximum affinity for SDS and minimal affinity for the protein sample. The low pH ensures protonated anionic side chains of a protein, reducing the chance of protein interaction with the packing material. Polymeric supports are a more resilient option at a low pH than silica-based anion exchangers. Selective binding of SDS to the trap should occur as the sample is pumped through the trap.

The protein should pass through unretained and may be sent for immediate analysis, or subjected to further on-line purification steps, such as concentration and desalting.

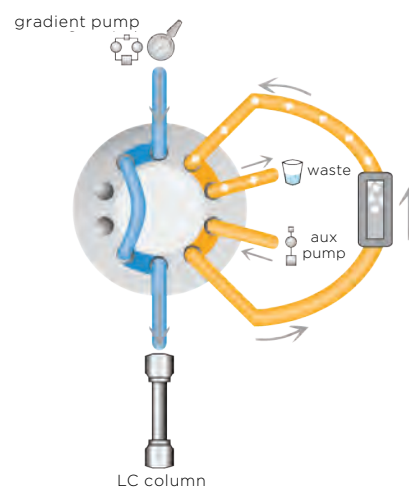
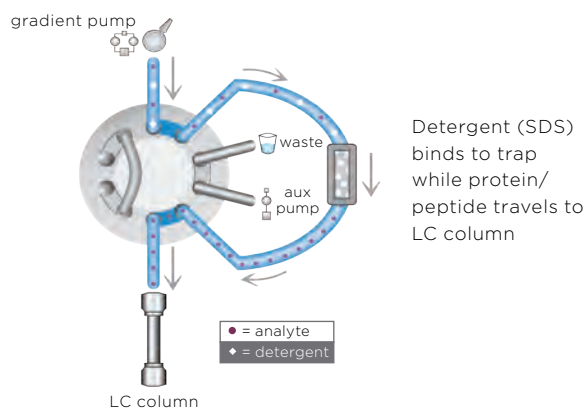

The anion exchange trap will have a finite capacity for SDS and must be regenerated before that capacity is exceeded.

This can be accomplished with a mobile phase that has a high concentration of organic eluent and is strongly acidic. A pH below 2 and an organic content above 90% should be sufficient.

# DETERGENT REMOVAL VIA TRAPPING

## NON-IONIC DETERGENT (NID) REMOVAL

Non-ionic detergents have hydrophobic characteristics and no charge. Therefore, ion-exchange approaches cannot be used. In NID removal, it is best to temporarily adsorb the protein within a trap while detergent is flushed to waste.

A packed bed with affinity for the target protein and little to no affinity for non-ionic detergents is used for separation.

This packed bed may consist of a single phase such as silica or polymeric SCX or even a mixture of phases such as SCX/SAX.

The most beneficial chemistry for a particular protein sample may need to be determined empirically.

Generally, a sample is delivered to a trap using a mobile phase with a low percentage of organic modifier. The proteins should bind to the packing material while the NID passes through unretained. (fig. 1)

If the isoelectric point (pI) of a protein is at or near the pH of a mobile phase, it may pass through the column unretained. If the pI of a protein is known, pH should be kept below pI for optimal interaction with an SCX trap, and either above or below for a mixed mode SCX/SAX trap. A salt solution of 0.5M concentration can be used to elute the protein after all of the detergent has passed through the trap. A reverse phase bed can be used to desalt the protein before sending it to an MS. In order to keep the desalting trap out of the flow stream during detergent removal, switching valves are required. (fig. 2)

Employing a “normal phase” trap is also a method for discarding of NID. The protein is loaded in high concentrations of organic solvent (80-95% acetonitrile) onto a highly polar stationary phase. The highly organic matrix is introduced in order to maximize the affinity of the sample for the polar stationary phase, and ensures near-complete binding of the sample and elimination of detergent. A gradient of decreasing organic or increasing salt concentration is then used to elute the protein.

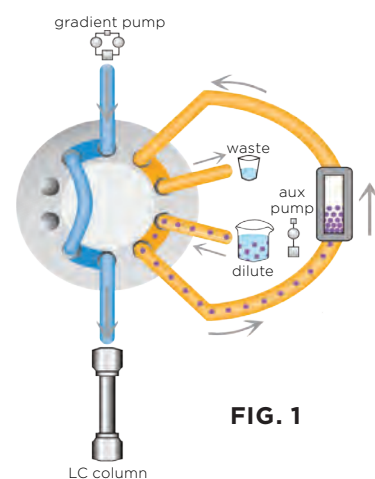

FIG. 1

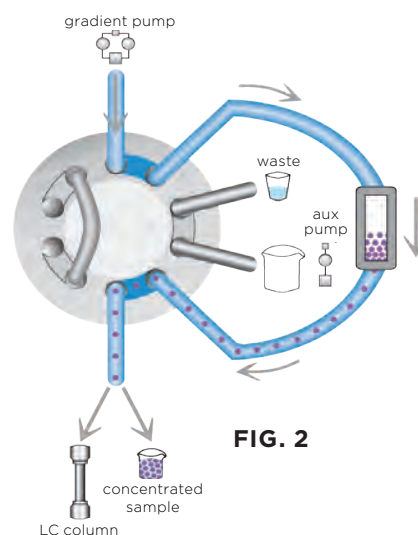

FIG. 2

# TRAP SPECIFICS

---

## SMALL MOLECULE CONCENTRATION & DESALTING TRAP

This trap contains a small pore, large particle, hydrophilic C18 silica (ODS-AQ) reversed-phase packing material and is designed to bind small molecules (0.1-10 kD). This includes many organic molecules such as pharmaceuticals, petrochemicals and natural products. Concentration of samples is possible with maximum efficiency. This trap removes salts (8M) and non-volatile buffers and is used at a pH range of 2-7.5.

### Quick Reference

1. Clean the trap with 5-10 trap volumes of "B solvent" (typically 90/10/0.005-0.1% acetonitrile/H<sub>2</sub>O/ion-pairing acid such as trifluoroacetic acid or heptafluorobutyric acid).
2. Equilibrate the trap with 5-10 trap volumes of "A solvent" (typically 2/98/0.005-0.1% acetonitrile/H<sub>2</sub>O/ion-pairing acid such as trifluoroacetic acid or heptafluorobutyric acid).
3. Add appropriate amount of acetonitrile and ion-pairing acid to sample to equal the composition of "A solvent."
4. Load sample onto trap at a loading rate within the recommended speed of loading for the size of trap in use. Do not overload the trap.
5. Remove salts from trap and flush to waste by washing with approximately 5 trap volumes of "A solvent."
6. Elute small molecules from trap. If performing on-line trapping, actuate the valve to the INJECT position and then run an increasing gradient of acetonitrile. For manual trapping, flush the trap with 1-2 trap volumes of 65-90% acetonitrile or "B solvent."
7. For full regeneration, flush the trap with several trap volumes of IPA.



## TRAP SPECIFICS

---

### PEPTIDE CONCENTRATION & DESALTING TRAP

Small biological molecules ranging from 0.5-50 kD can be bound and concentrated with a peptide concentration & desalting trap. This is done by using a medium pore, large particle, polymeric reversed-phase packing material with retention similar to a C8 phase. Operating at a pH range of 1-13, this trap removes salts (8M) and non-volatile buffers.

#### Quick Reference

1. Clean the trap with 5-10 trap volumes of “B solvent” (typically 90/10/0.005-0.1% acetonitrile/H<sub>2</sub>O/ion-pairing acid such as trifluoroacetic acid or heptafluorobutyric acid).
2. Equilibrate the trap with 5-10 trap volumes of “A solvent” (typically 2/98/0.005-0.1% acetonitrile/H<sub>2</sub>O/ion-pairing acid such as trifluoroacetic acid or heptafluorobutyric acid).
3. Add appropriate amount of acetonitrile and ion-pairing acid to sample to equal the composition of “A solvent.”
4. Load sample onto trap at a loading rate within the recommended speed of loading for the size of trap in use. Do not overload the trap.
5. Remove salts from trap and flush to waste by washing with approximately 5 trap volumes of “A solvent.”
6. Elute peptides from trap. If performing on-line trapping, actuate the valve to the INJECT position and then run an increasing gradient of acetonitrile. For manual trapping, flush the trap with 1-2 trap volumes of 65-90% acetonitrile or “B solvent.”
7. For full regeneration, flush the trap with 70:30 formic acid:IPA.

## TRAP SPECIFICS

---

### PROTEIN CONCENTRATION & DESALTING TRAP

When working with large biological molecules ranging from 5-500 kD, a protein concentration and desalting trap may be used for concentration or removal of salts (8M) and non-volatile buffers.

The packed bed consists of a large pore, large particle, polymeric reversed-phase packing material with retention similar to a C4 phase. This functions at a pH range from 1-13.

#### Quick Reference

1. Clean the trap with 5-10 trap volumes of "B solvent" (typically 90/10/0.005-0.1% acetonitrile/H<sub>2</sub>O/ion-pairing acid such as trifluoroacetic acid or heptafluorobutyric acid).
2. Equilibrate the trap with 5-10 trap volumes of "A solvent" (typically 2/98/0.005-0.1% acetonitrile/H<sub>2</sub>O/ion-pairing acid such as trifluoroacetic acid or heptafluorobutyric acid).
3. Add appropriate amount of acetonitrile and ion-pairing acid to sample to equal the composition of "A solvent."
4. Load sample onto trap at a loading rate within the recommended speed of loading for the size of trap in use. Do not overload the trap.
5. Remove salts from the trap and flush to waste by washing the trap with approximately 5 trap volumes of "A solvent."
6. Elute proteins from the trap. If performing on-line trapping, actuate the valve to the INJECT position and then run an increasing gradient of acetonitrile. For manual trapping, flush the trap with 1-2 trap volumes of 65-90% acetonitrile or "B solvent."
7. For full regeneration, flush the trap with 70:30 formic acid:IPA.

## TRAP SPECIFICS

---

### SDS REMOVAL TRAP

A large pore, large particle, polymeric strong anion exchange packing material is used for these traps. They are designed to bind anionic detergents such as sodium dodecyl sulfate (SDS) at low pH (2-4). This trap removes SDS at concentrations as high as 1%. If higher concentrations of SDS are present in a sample, the risk of forming micelles that trap analytes along with the SDS micelle complex. Such samples must be diluted below 1% first. The trap works at a pH range of 1-13.

#### Quick Reference

1. Clean the trap with 5-10 trap volumes of “B solvent” (typically 90/10/0.005-0.1% acetonitrile/H<sub>2</sub>O/ion-pairing acid such as trifluoroacetic acid or heptafluorobutyric acid).
2. Equilibrate the trap with 5-10 trap volumes of “A solvent” (typically 2/98/0.005-0.1% acetonitrile/H<sub>2</sub>O/ion-pairing acid such as trifluoroacetic acid or heptafluorobutyric acid).
3. Add an appropriate amount of acetonitrile and ion-pairing acid to sample to equal the composition of “A solvent.” Note: pH must be between 2-4.
4. Load sample onto trap at a loading rate within the recommended speed of loading for the size of trap in use. Do not overload the trap. SDS will bind to the trap while proteins pass through.
5. Capture proteins as they pass through the SDS removal trap for further analysis. If performing on-line trapping, add 5-10 trap volumes of “A solvent” to allow concentration and desalting of proteins on the protein trap. If performing manual SDS removal, add 1-2 trap volumes of “A solvent” to allow all proteins to pass through SDS removal trap.
6. Actuate the valve to the INJECT position and elute proteins from concentration and desalting trap by running an increasing gradient of acetonitrile. While in the inject position, also clean the SDS trap and route retained SDS to waste by flushing with 5-10 trap volumes of 90% acetonitrile/ 0.1% HCl.
7. Fully regenerate trap by flushing with 90% acetonitrile/ 0.1% HCl.

## TRAP SPECIFICS

---

### NID (NON-IONIC DETERGENT) REMOVAL TRAP

Using a mixed bed of large pore, large particle, silica-based weak anion and weak cation exchange packing material, this trap is designed to bind charged proteins and/or peptides. This trap removes non-ionic detergents such as Triton X-100 and Tween-80 by allowing the uncharged detergents to pass through. The trap works at a pH range of 2-7.5.

#### Quick Reference

1. Clean the trap with 5-10 volumes of 10% acetonitrile/0.5M NaCl.
2. Equilibrate the trap with 5-10 trap volumes of 10% acetonitrile/10mM buffer, pH 7.0 (or some other pH not corresponding to the pI of proteins).
3. Add appropriate amount of acetonitrile and buffer solution to sample to allow sample to contain 10% acetonitrile buffered at pH 7.0 (or at some other pH not corresponding to the pI of proteins).
4. Load sample onto trap at a loading rate within the recommended speed of loading for the size of trap in use. Do not overload the trap. NID will pass through the trap while proteins remain on the NID removal trap.
5. Release proteins from the NID removal trap using 1-2 trap volumes of 10% ACN/0.5M NaCl. If performing on-line trapping, then load 5-10 trap volumes of "A solvent" (typically 2/98/0.005-0.1% acetonitrile/H<sub>2</sub>O/ion-pairing acid such as trifluoroacetic acid or heptafluorobutyric acid) to allow concentration and desalting of proteins on the protein trap. Note: some proteins require up to 5% ACN in "A solvent."
6. Actuate the valve to the INJECT position and elute proteins from concentration and desalting trap by running an increasing gradient of acetonitrile.
7. Fully regenerate trap by flushing with 10% acetonitrile/0.5M NaCl.

## TRAP SPECIFICS

---

### SCX (STRONG CATION EXCHANGE) TRAP

A packed bed consisting of silica-based strong cation exchange material with medium pores and large particles is designed to bind small positively charged molecules from 0.5 to 50 kD. At a pH of 2.7-3.0, peptides will lose their negative charge and have a net positive charge. The trap is used in a pH range of 2.7 to 7.0. A pH of less than 2.7 will destroy the phase.

#### Quick Reference

1. Clean the trap with 5-10 trap volumes of “high salt buffer, pH 3” of choice.  
Example: 5mM NaH<sub>2</sub>PO<sub>4</sub>, pH 3.0, with 25% acetonitrile and 0.25M KCl. Note: If using a peptide concentration and desalting trap in tandem with SCX trap for 2D analysis, a good buffer is 5/90/2.5/2.5/0.05% acetonitrile/H<sub>2</sub>O/30% ammonium hydroxide/formic acid/HFBA (“D buffer”).
2. Equilibrate the trap with 5-10 trap volumes of “low salt buffer.” Example: 5mM NaH<sub>2</sub>PO<sub>4</sub>, pH 3.0, with 25% acetonitrile. Note: If using a peptide concentration and desalting trap in tandem with SCX trap for 2D analysis, a good buffer is 5/95/0.1/0.005% acetonitrile/H<sub>2</sub>O/formic acid/HFBA (“C buffer”).
3. Add an appropriate amount of acetonitrile and buffer to the sample to obtain pH 3.0 and 25% acetonitrile to match the “C buffer.”
4. Load sample onto trap at a loading rate within the recommended speed of loading for the size of trap in use. Do not overload the trap.
5. Release peptides from the trap using 1-2 trap volumes of “high salt buffer” or perform salt steps with increasing concentrations of salt. If performing on-line trapping, then load 5-10 trap volumes of “C buffer” to allow concentration and desalting of peptides on peptide trap.
6. Actuate the valve to the INJECT position and elute peptides from concentration and desalting trap by running an increasing gradient of acetonitrile.
7. For full regeneration, flush the trap with a “high salt buffer” of choice.

## TRAP SPECIFICS

---

### ISRP PROTEIN REMOVAL TRAP

This technique utilizes an Internal Surface Reversed-Phase trap, which contains a very small pore, large particle, silica-based internal surface, reversed-phase packing material. This trap is designed to bind small molecules (0.1-5 kD) onto C18 chains within the internal surface of the pores of the packing material. Protein removal from plasma, urine and serum samples is possible by excluding the proteins from the shielded hydrophobic phase. This allows them to pass through the interparticulate spaces. This works at a pH range of 2-7.5.

### Quick Reference

1. Clean the trap with 5-10 trap volumes of "B solvent" (typically 90/10/0.005-0.1% acetonitrile/H<sub>2</sub>O/ion-pairing acid such as trifluoroacetic acid or heptafluorobutyric acid).
2. Equilibrate the trap with 5-10 trap volumes of equilibration buffer, pH 7.0. Example buffer: 5/95 acetonitrile/180mm ammonium acetate.
3. Add appropriate amount of acetonitrile and buffer to sample to equal the composition of the equilibration buffer.
4. Load sample onto trap at a loading rate within the recommended speed of loading for the size of trap in use. Do not overload the trap.
5. Remove proteins and salts from trap and flush to waste by washing with approximately 5 trap volumes of equilibration buffer.
6. Elute small molecules from trap. If performing on-line trapping, actuate the valve to the INJECT position and then run an increasing gradient of acetonitrile. For manual trapping, flush the trap with 1-2 trap volumes of 65-90% acetonitrile or "B solvent."
7. Fully regenerate the trap by flushing it with IPA.

# PATENTS & TRADEMARKS

---

## OPTIMIZE TRADEMARKS

TI-LOK™, OPTI-TRAP™, OPTI-DRAW™, OPTI-LOK™, OPTI-PEEK™, OPTI-LYNX™, HPLC First Aid Kit™, HPLC Switch Kit™, HPLC-Finder™, ITB™, HEAD•LOCK™, “At The Speed of Discovery”™, OS-10.1™, the Optimize Technologies Raindrop Logo, and Free-Turn® are trademarks of Optimize Technologies, Inc.

The OPTI®- prefix, OPTI-MAX®, OPTI-GUARD®, OPTI-PAK®, OPTI-PRIME®, OPTI-SEAL®, OPTI-SOLV®, EXP®, Optimize Technologies® and Velocity® are registered trademarks of Optimize Technologies, Inc.

## OPTIMIZE PATENTS

EXP®: U.S. Pat. No.s 8,696,902; D766,055 and U.S. and foreign patents pending.

Hybrid Ferrule: U.S. Pat. No. 8,201,854

## NON-OPTIMIZE TRADEMARKS

Hastelloy C® is a registered trademark of Cabot Corporation.

PEEKsil® is a trademark of SGE International Pty. Ltd.

Halo® is a registered Trademark of Advanced Materials Technology Inc.

The names of all OEM instrument and equipment manufacturers listed in this catalog are trademarks and/or registered trademarks of their respective owners, as are the names and model numbers of the instruments and equipment referenced herein.

# PRODUCT INDEX

---

## A

Adapters, 12  
 Agilent, components for, 55-57  
     Active Inlet Valve Replacement for Agilent, 55-56  
 Alcott, components for, 59  
 Altex, components for, 58  
 Amersham, components for, 63  
 Analytical Columns, 43  
 Anspec, components for, 59

## B

Back Pressure Regulators, 44  
 Beckman, components for, 58  
 Bischoff, components for, 59

## C

Check valves, cartridge  
     OPTI-MAX® Cartridge Check Valve System,  
     47-50, 53-54  
     See also, specific manufacturer pages  
 Columns  
     Analytical Columns, 43  
     Guard Columns, 39-42  
     Trap Columns, 29-38  
 Conversion Kits, 53-54  
 Custom Manufacturing, 1-2, 74

## D

Dionex, components for, 60

## E

ESA, components for, 65-66  
 EXP® and EXP®2 for UHPLC,  
     Innovation Spotlight, 3-4  
     Fittings, 7-8, 13-19  
     Adapters 18-19  
     DIY Fittings & Adapter Kits 19  
     Filtration, 21-22, 27-28  
         Stem Filter, 27  
         Pre-Column Filter, 28  
         In-Line Filter, 28

EXP and EXP2 for UHPLC continued

Multi-Purpose Packed Beds, 29-30, 33-38,  
 39-40, 42, 43  
     Nano Trap, 33-34  
     Stem Trap, 35-36  
     Trap Column, 37-38  
     Guard Column, 42  
     Analytical Column, 43

## F

Filters, 21-28  
     Introduction, 21-22  
     Solvent Reservoir Filters  
         OPTI-SOLV® Solvent Reservoir, 23  
     Pre-Column and In-Line Filters  
         OPTI-SOLV® In-Line, 24  
         OPTI-SOLV® Mini, 25  
         OPTI-SOLV® Micro, 26  
         OPTI-SOLV® Nano, 26  
         EXP®2 Stem, 27  
         EXP®2 Pre-Column, 28  
         EXP®2 In-Line, 28  
 Fittings, 7-19  
     Introduction, 7-8  
     OPTI-LOK™ Low Pressure, 9  
     OPTI-LOK™ High Pressure, 10  
     OEM Specific Fittings, 11  
     OPTI-LOK™ Adapters, 12  
     EXP® and EXP®2 for UHPLC, 3-4, 7-8, 13-18  
 Free-Turn® Introduction, 49

## G

Gilson, components for, 69-70  
 Guard Columns, 39-42  
     Introduction, 39-40  
     OPTI-GUARD® 1mm, 41  
     EXP® Guard Column, 42

## H

Hitachi, components for, 61  
 Hewlett Packard, components for, 55-57  
 HPLC Finder™, 46



## J

Jasco, components for, 62

## L

Lamps, 57, 60, 62-64, 66-68, 70, 73

See also specific manufacturer pages

LDC (Thermo), components for, 67

LKB, components for, 63

## M

Milton Roy (Thermo), components for, 67

## O

OPTI-GUARD® 1mm Guard Column, 41

OPTI-LOK™ Fittings, 7-12

OPTI-LYNX™ Quick-Connect System, 5-6, 22, 30, 32, 40

Innovation Spotlight, 5-6

Micro Trap, 32

OPTI-MAX® Cartridge Check Valves, 45-50, 53-56, 58-65, 67-69, 71

Introduction, 47-50

Conversion Kits, 53-54

Replacement Cartridges, 50

OPTI-PAK® Trap Column

See EXP® Stem Trap, 35-36

OPTI-PEEK™ Tubing, 20

OPTI-SOLV® Filters, 23-26

OPTI-TRAP™ Trap Columns, 31

Ordering Information, 91

## P

Patents, 88

PerkinElmer, components for, 64

Pharmacia, components for, 63

Pistons and Seals, 45, 51

See also, specific manufacturer pages

## R

Rainin, components for, 69-70

Regulators, Back Pressure, 44

## S

Seals and Pistons, 45, 51

See also, specific manufacturer pages

Seal Form Insertion Tool Kit, 52

Shimadzu, components for, 65-66

Spectra-Physics (Thermo), components for, 68

## T

Thermo, components for, 67-68

Trademarks, 88

Trap Cartridges / Columns, 29-38

Introduction, 29-30

OPTI-TRAP™ Trap Columns, 31

OPTI-LYNX™ Micro Trap, 32

OPTI-PAK® Trap Column

See EXP®2 Stem Trap, 35-36

EXP® and EXP®2 for UHPLC

Nano Trap, 33-34

Stem Trap, 35-36

Trap Column, 37-38

Trapping Guide, 75-87

Tubing, 20

OPTI-PEEK™, 20

Stainless Steel, 20

PTFE, 20

ETFE, 20

Tubing Cutters, 20

## U

UHPLC | EXP® and EXP®2

Innovation Spotlight, 3-4

Fittings, 7-8, 13-18

Filtration, 21-22, 27-28

Stem Filter, 27

Pre-Column Filter, 28

In-Line Filter, 28

Multi-Purpose Packed Beds, 29-30, 33-38, 39-40, 42-43

Nano Trap, 33-34

Stem Trap, 35-36

Trap Column, 37-38

Guard Column, 42

Analytical Column, 43

OPTI-MAX® Check Valve Cartridges, 50

See also, specific manufacturer pages

Seals and Pistons, 51

See also specific manufacturer pages

## V

Varian, components for, 69-70

Velocity® Analytical Column System

See EXP® Analytical Columns, 43

## W

Waters, components for, 71-73

## ORDERING INFORMATION

### OUR GUARANTEE OF SATISFACTION

Optimize products are fully guaranteed to meet or exceed original equipment specifications and to meet or exceed your expectations. Satisfaction is guaranteed. If our products do not meet your expectations, please contact Optimize or the distributor from whom you purchased the item. A Return Materials Authorization (RMA) number must be obtained before the product can be returned. The RMA number allows us to properly identify returned goods and to resolve problems quickly and efficiently. Optimize Technologies is not responsible or liable for goods returned without prior authorization.

### TERMS AND CONDITIONS

Net 30 days from invoice date with approved credit. We also accept credit cards and prepayment orders. Charges for shipping and insurance are prepaid and added to invoices.

### PRICING

Prices published in print or on the web are subject to change without prior notice. For current pricing and availability, please contact Optimize.

### SHIPPING

All goods listed in this catalog are shipped FOB Oregon City, Oregon, USA. Standard/stock items are usually shipped within 24 hours. Shipments are sent best way (UPS or FedEx) unless alternate shipping instructions are provided. Orders placed by 12:00 PM PST are usually shipped the same day if in stock.

---

### TO ORDER IN THE U.S. OR INTERNATIONALLY

Orders can be placed on our website at [www.optimizetech.com](http://www.optimizetech.com) or with your preferred authorized Optimize distributor. The latest authorized distributor list is available on our website. We accept Visa, Mastercard, American Express, check, and purchase orders with approved credit. If you prefer to place an order by phone or fax, please contact Optimize at the numbers below.

PHONE: 800.669.9015 or 503.557.9994

FAX: 503.557.9995

### MAILING AND SHIPPING ADDRESS:

Optimize Technologies, Inc.

13993 Fir Street

Oregon City, OR 97045, USA

While every effort has been made to ensure the accuracy of information contained in our catalogs, price lists and web sites, Optimize Technologies, Inc. accepts no responsibility for errors or omissions.

# Join Optimize in supporting CASA

Court Appointed Special Advocates (CASAs) are a special kind of volunteer. When a child is removed to protective custody, their volunteer advocate provides a voice in court and dedicated support in finding the safe and permanent home where he or she will thrive.

CASA volunteers contact caseworkers, interview parents and other family members, ensure children receive necessary medical care, look out for educational interests, and make recommendations in court regarding the permanent placement of the child. Most importantly, they serve as a constant person for that child to count on during a very tumultuous time.

Today, the National CASA Association represents more than 948 CASA programs in 49 states, Washington, D.C., and the U.S. Virgin Islands. It provides support for starting programs, technical assistance, training, fundraising, media, and public awareness services.

Since its creation in 1977, CASA has had a dramatic impact on the nation's court system. Programs often differ from one jurisdiction to another, with varying operation methods and sources of funding. CASA is known at the local level by a variety of other names. Some examples are: Voices for Children, ProKids, or Guardian Ad Litem (GAL).

Optimize is a proud supporter of our local CASA chapter. To support your local CASA program or become a volunteer, please visit [casaforchildren.org](http://casaforchildren.org).



INNOVATIVE HPLC,  
UHPLC & LC/MS PRODUCTS



**OPTIMIZE  
TECHNOLOGIES**

13993 Fir Street  
Oregon City, OR 97045  
TF: 800.669.9015  
Tel: 503.557.9994  
Fax: 503.557.9995  
[www.optimizech.com](http://www.optimizech.com)

