

EPROGEN



2022 Catalog

**Promigen Life Sciences, LLC
(Eprogen)
MICRA HPLC Columns**

***"Mapping New Directions in
Proteomics"***

ORDER INFORMATION:

In the United States contact:

Promigen Life Sciences, LLC

d/b/a Eprogen

2753 Curtiss St.

Downers Grove, IL 60515-4002

Tel: 630-963-1481

FAX: 630-963-6432

Info@eprogen.com

www.eprogen.com

WARRANTY

The entire MICRA-HPLC column line, manufactured by Eprogen, is warranted to be free from defects in material and workmanship for 30 days from date of receipt. All columns are individually tested and packaged with a quality assurance chromatogram.

RETURNS

Product returns will not be accepted without prior authorization. There is a 15% restocking charge for returned items.

LIABILITY

Eprogen's products are intended for laboratory use only, not as drugs, food, or for household usage. These products must be handled with due care and only by professional laboratory staff.

LITERATURE

Application notes, chromatograms, technical notes, poster reprints, literature reprints and a reference bibliography for both porous and non-porous phases are available upon request.

Table of Contents

Who is Eprogen?	4
Column Selection guide for MICRA-HPLC supports	5
Benefits Guide for MICRA-Platinum, MICRA-Gold, and MICRA Silver	6

MICRA-Platinum Reversed Phase HPLC Columns

Featured advantages of MICRA-Platinum NPS non-porous silica.....	8
NPS ODS-I	10
ODS-II (HPRP)	12
ODS-IIIE	13
ODS-TAS and NPS -Sil	14
NPS Information and Operating Instructions	15
Applications in LC/MS	16
MICRA-Platinum SCD-MS	17

MICRA-Gold HPLC Columns

Reversed Phase	18
Reversed Phase SCD Specialty Support	19
Cation Exchange	20
Anion Exchange	21
Size Exclusion (GPC).....	23
Size Exclusion Cationic-Polymer (CATSEC)	25
Size Exclusion GPC PEP and GPC LINEAR	27

MICRA-Silver HPLC Columns

Reversed Phase	28
Anion Exchange	29
Cation Exchange	30

Column Usage Guidelines	32
--------------------------------------	----

Who is Eprogen?

Promigen Life Sciences, LLC [Eprogen] is a bioanalytical chemistry company specializing in the separation and analysis of large molecule and complex protein systems. This was enhanced by the acquisition of the SynChropak line of bonding chemistries developed in the 1990's and Eprogen's patented non-porous silica particle **NPS** technology. Our mission is to develop the next generation of utilitarian tools and techniques to mine more efficiently and deeply into the proteomes of cells, tissues and biofluids. We combine the high-resolution separation principles of chromatographic methods with the highly specific protein detection capabilities of molecular biology methods to produce unique solutions to clinical proteomics and protein biomarker discovery and development.

HPLC Markets Served

HPLC products are manufactured to meet the specific application needs in the areas of life science and proteomics separations along with the traditional pharmaceutical and small molecule separations. We have worldwide network of international distributors that support an international customer base.

Chromatographic Techniques/Product Offering

HPLC and LCMSⁿ column products are offered in Reversed Phase, Anion and Cation Exchange (Both weak and strong) & various Size Exclusion (GPC) formats.

Eprogen's MICRA-Platinum, MICRA-Gold, and MICRA-Silver columns are manufactured to meet the demands for exceptional performance in analytical applications. All porous phases are based on SynChropak bonding chemistry known for its excellent resolution, stability, and reproducibility. The **NPS** particles are derived from a patented "metal free" manufacturing process. They are highly uniform pure spherical particles with a high degree of monodispersity. This brings advantages to the HPLC marketplace which complement standard porous supports.

Column Performance Options

MICRA-Platinum Columns

- Reversed Phase and Normal Phase
- 1.5 μ & 3.0 μ **NPS** & 3.0 μ porous silica
- High throughput/LC-MS applications
- Three C-18 bonded phases for **NPS**
- **NPS** TAS offers extra resolving power
- SCD (Short Chain, Base Deactivated) for porous silica

MICRA-Gold Columns

- Reversed Phase - Ion Exchange - Size Exclusion
- 5 μ , 7 μ , 10 μ Spherical Silica
- 100 \AA , 300 \AA , 500 \AA , 1000 \AA , 4000 \AA Pore Sizes
- Unique to the industry:
 - "SCD100" for drug applications
 - "CATSEC" for cationic polymers

MICRA-Silver

- C-8 & Ion Exchange
- 6.5 μ , 300 \AA , Spheroidal Silica
- Tailored for protein and peptide separations for Methods Development
- Well Suited for Preparative Formats

Guide to Eprogen-HPLC Supports

MICRA HPLC-Line	Particle size (µ)	Pore size (Å)	Phase Description	Phase Characteristics	MW Range	Specific Application	USP XXII
SILVER RP							
RP8	6.5	300		monomeric	>1,000	peptides/proteins	L7
SILVER IEX							
AX300	6.5	300	WAX	polyethyleneimine	<200,000	peptides proteins Hemoglobin Variants	
Q300	6.5	300	SAX	quaternary amine	<200,000		
CM300	6.5	300	WCX	carboxymethyl	<200,000		
S300	6.5	300	SCX	Sulfonic Acid	<200,000		
GOLD IEX							
AX100	5	100	WAX	polyethyleneimine	<10,000	organic acids/nucleotides	
AX1000	7	1000			>200,000	Large proteins	
Q100	5	100	SAX	quaternary amine	<10,000	peptides amines	
CM100	5	100	WCX	carboxymethyl	<10,000	proteins	
S1000	7	1000	SCX	Sulfonic Acid	>200,000		
GOLD RP							
RP4 4000	10	4000		C4	>1000	peptides/proteins	L7
SCD 100	5	120		CN and EC	<1000	small molecules/basic drugs	L1
GOLD Size Exclusion					MW range		
GPC Peptide	5	50	GPC	Glycerol	See page 27	peptides	L20,33
GPC100	5	100				Proteins & neutral/acidic polymers	
GPC300	5	300					
GPC500	7	500					
GPC1000	7	1000					
GPC4000	10	4000					
GPC Linear	7	100/1000					
CATSEC100	5	100	SEC	Polyamine	See page 29	cationic polymers	
CATSEC300	5	300					
CATSEC1000	7	1000					
CATSEC4000	10	4000					
PLATINUM RP							
RP 4	3	100	C4	monomeric e/c	<200,000	Proteins	
SCD-MS	3	100	CN/C2	base-deactivated, e/c polymeric	<1,000	rapid / LC-MS hydrophobic small molecule	
NPS ODS-I	1.5	NPS	C-18	polymeric	<200,000	Small molecules	
NPS ODS-II (HPRP)				monomeric	<200,000	Proteins	
NPS ODS-III				monomeric e/c	<200,000	Basic Drugs	
NPS - PAH				polymeric	<1,000	16 PAH certified	
NPS			C-30	monomeric	<1,000	carotene analysis	
PLATINUM NP							
NPS-SIL	1.5	non-porous			<1,000	rapid normal phase separations	

Guide to Eprogen-HPLC Supports

MICRA-Platinum columns represent the state-of-the-art in column chromatography. This performance category includes column supports containing the **NPS** non-porous silica particle technology available in a 1.5 μ & 3.0 μ size, as well as 3.0 μ porous supports derived from the SynChropak bonding chemistry. These columns are designed for the analysis and purification of peptides/proteins, basic/acidic molecules, and pharmaceutical compounds by high throughput analysis or LC/MS techniques. This line of columns provides exceptional performance in speed of analysis, sensitivity, stability, reproducibility, and low sample/solvent waste. **NPS** is an ultra-high purity silica made using a patented, "metal free" manufacturing procedure developed by Eprogen.

Three **NPS** C18 bonding chemistries are offered to meet selectivity needs:

- ODS-I, a polymeric C18, offers the larger operating pH range and high column stability.
- ODS-II, a monomeric C18, provides a more stable, hydrophilic surface for improved selectivity of polar and neutral analytes. It is the preferred column for protein and peptide separations.
- ODS-IIIE, an end-capped, monomeric C18, is designed for analysis of basic drugs and small molecules.

Three **NPS** specialty columns include:

- **NPS** TAS, a C30 extended chain length is suited for carotenoid analysis and fat-soluble vitamins.
- **NPS** PAH, offers excellent resolution of the 16 priority pollutants in less than 8 minutes.
- **NPS** SIL, is well suited for normal phase analysis and LC-MS applications.

Porous supports for high throughput and LC-MS applications:

- 3 μ SCD-MS is a base deactivated phase designed for pharmaceutical analysis.

MICRA-Gold columns are Eprogen's standard line of porous HPLC columns. They are based on SynChropak bonding chemistry and designed for the analysis and purification of proteins, peptides, polymers, basic/acidic molecules, and pharmaceuticals.

Reversed Phase

RP4 is well-suited for high loading and high-resolution separation of peptides and excellent recovery for proteins.

Ion exchange

These 100 \AA weak and strong cation and anion exchangers offer excellent selectivity based on ionic properties of a solute. They are appropriate for separating closely related organic acids, nucleotides ranging from mono to triphosphates, and peptides which differ by only one or two amino acids.

Size Exclusion

Eprogen's GPC series contains products with pore diameters (50 \AA -4000 \AA) allowing analysis of solutes with molecular weights ranging from 0.5 kDa to 10,000 kDa. The glycerol bonded phase is designed for the rapid analysis of proteins, carbohydrates, nucleic acids, and other water soluble anionic or neutral polymers. The MICRA-Gold CATSEC series, exclusive to Eprogen, is a polymerized polyamine support available in four diameters (100 \AA -4000 \AA) allowing the analysis of cationic polymers such as polyvinylpyridines to elute according to size and without adsorption.

The MICRA-Silver series offers economic benefits to method development and preparative work. They are well suited for dedicating columns to specific analyses and scaling up from analytical to preparative applications. The RP-8 phase is a monomeric bonded C8 phase and is appropriate for separating smaller proteins and peptides with a less hydrophobic nature. Both weak and strong anion and cation exchange supports are available for separating ionic compounds. They are compatible with aqueous buffers and many organic solvents in the pH 2-8 range.

EPROGEN (MICRA) HPLC SUPPORTS

MICRA Platinum

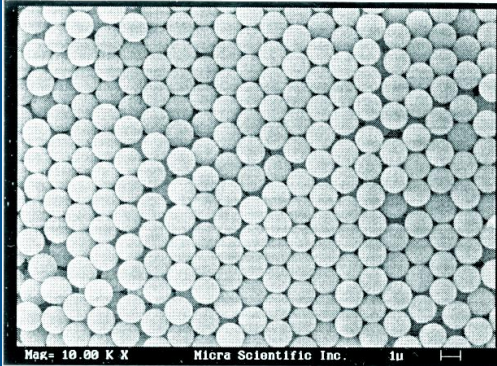

- 1.5 μ and 3.0 μ highly spherical and uniform porous and **NPS** non-porous silica.
- Short run times
- Low solvent consumption
- High sensitivity

Available phases include **NPS** :
ODS-I, ODS-II, ODS-III, TAS, PAH certified: SIL

& Porous:
3.0 μ SCD-MS

MICRA Gold

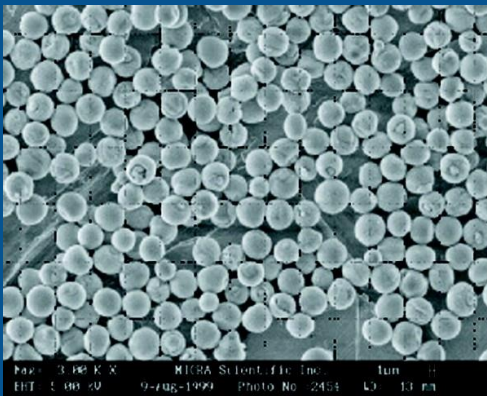

- Spherical silica of very uniform size
- Particle sizes 5 μ , & 10 μ
- Pore sizes 50 \AA , 100 \AA , 300 \AA , 500 \AA , 1000 \AA , 4000 \AA
- Phases available include:
 - Reversed phase:
RP4 (100 \AA) RP8 (300 \AA) SCD100 (100 \AA)
 - Anion Exchange: AX100 AX1000 Q (100)
 - Cation Exchange: CM100, S1000
 - Size Exclusion:
GPC PEP, GPC Linear
GPC100, 300, 500, 1000, 4000
CATSEC100, 300, 1000, 4000

MICRA Silver

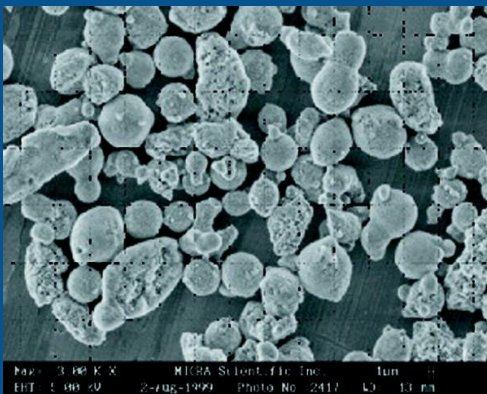

6.5 μ , 300 \AA , Spheroidal silica

- Column sizes: 2-10mm ID & 50-300mm length
- Phases available include:

Reversed phase: RP4, RP8
Anion exchange: AX300, Q300
Cation exchange: CM300, S300

MICRA *NPS* 1.5 μ silica

FAST CHROMATOGRAPHY AND HIGH RESOLUTION

The goal of fast chromatography is to reduce analysis time while still maintaining good resolution. Several ways to improve speed are possible. The most widely used means have centered on using shorter columns packed with smaller particles and increasing flow rate. These methods do not alter the selectivity nor the retention factor (**k**) of the components. The analyte resolution will change only with changes in column efficiency (**N**) which is directly linked to the column length (**L**) and particle size (**d_p**) by the equations (**H = L/N**) and (**N \propto 1/d_p**). The ideal case for fast chromatography is to use short columns packed with small particles to maximize speed while maintaining column efficiency. Column efficiency, however, can be further enhanced by minimizing mass transfer effects associated with the support material. The use of nonporous particles eliminates the pore diffusion terms (**B & C**) of the van Deemter equation (**H = A + B/u + Cu**). As shown in the van Deemter plots below, columns packed with 1.5 μ *NPS* particles exhibit very high efficiencies that are insensitive to changes in flow rate or linear velocity (**u**). MICRA *NPS* represents the ideal HPLC column support for fast separations at the highest resolution possible.

RETENTION FACTOR AND SPEED

Eliminating pores also reduces the available surface area for C18 bonding. For a given diameter of highly uniform nonporous silica particle, the surface area is calculated from the density and particle diameter of the silica. For *NPS* we typically measure a density (**ρ**) of 2.1 ± 0.1 g/mL. For a 1.5 μ *NPS* material, the surface area is $6/(\rho \times d_p) = 1.9$ m²/g (a typical 100Å, 5 μ porous support has a surface area of around 200 m²/g and a silica density of 0.4 g/mL).

The distribution coefficient (**K**), the support volume (**V_s**) and the mobile phase volume (**V_m**) contribute to the distribution of solute between the stationary surface and moving liquid. The pores themselves do not change the solute-solvent equilibrium to any significant degree. The surface area of the support is, therefore, very representative of the support contribution to the equilibrium of the column. Eliminating the porosity eliminates 50% of the available liquid volume (**V_m**) in a packed column (**V_{m,NPS} \approx 1/2 V_{m,porous}**) of the same dimensions.

In reversed phase separations, the equation **k' = KV_s/V_m** is used to compare the expected values of **k'** for the two supports: We know **V_s** based on the surface area x particle density (m²/mL). For the same column volume and mobile phase composition: **V_{s,NPS} \approx 1/20 V_{s,porous} \Rightarrow **k'_{NPS} \approx 1/10 k'_{porous}****

This means that, all things being equal, analytes will elute \sim 10 times faster on *NPS* supports compared to porous supports. This is the reason for the significant solvent savings for separations using *NPS* supports with the added benefit of increased resolution.

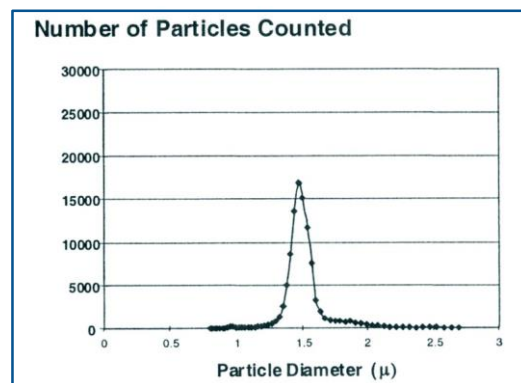
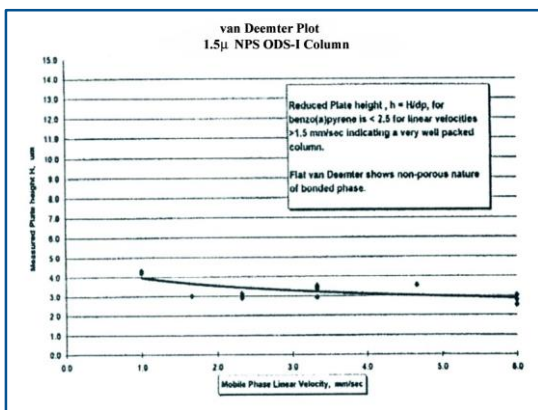

MICRA-Platinum Reversed Phase HPLC columns

NPS benefits

Illustrations show advantages of using columns packed with nonporous silica over columns packed with the more traditional porous silica.

Faster Separations & Lower Organic usage

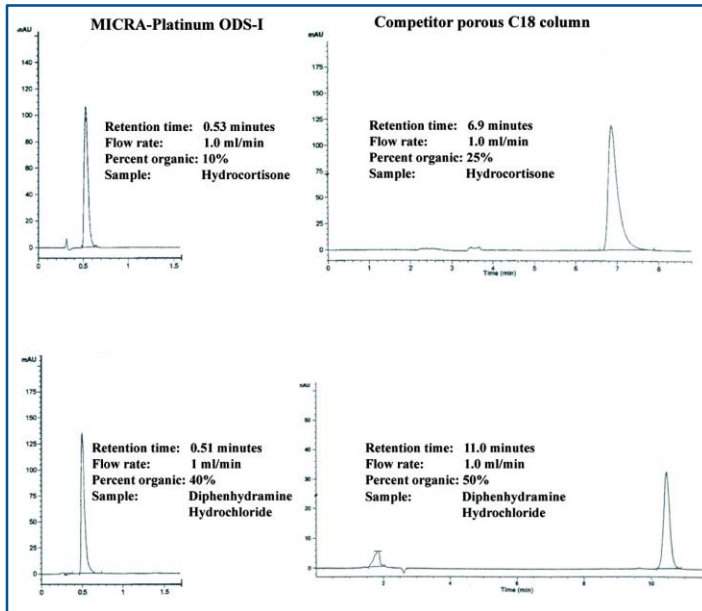

High Sensitivity

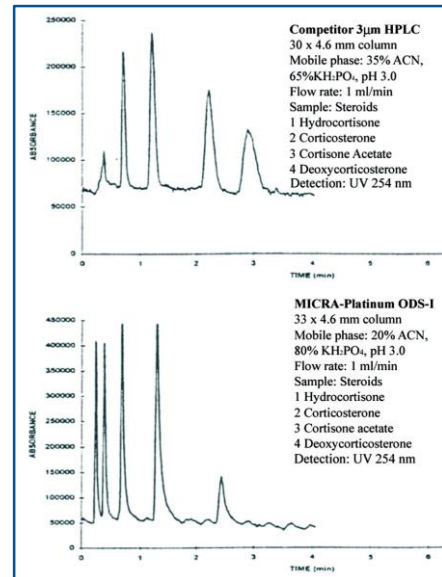

Improved Stability

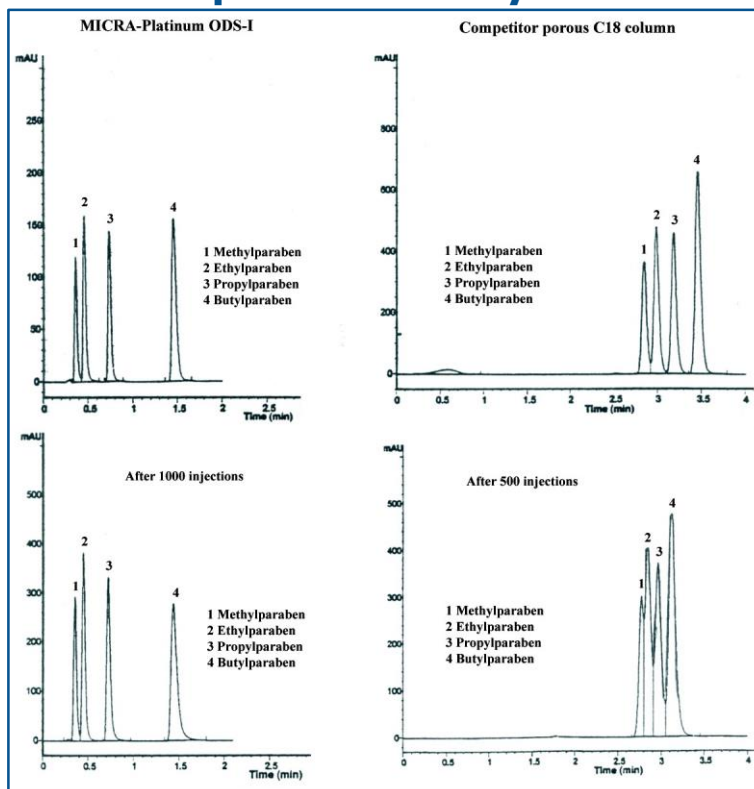

MICRA-Platinum Reversed Phase HPLC columns

NPS ODS-I

The 1.5 μ **NPS** ODS-I is a premium support of choice for most separations. It offers an excellent combination of stability, versatility, efficiency, and shape selectivity for a broad range of separations. This is a polymeric C-18 bonding and yields low surface silanol activity, without end-capping. ODS-I offers fast and efficient separations in the areas of pharmaceutical, life science, and environmental analysis applications.

Pharmaceutical

With the addition of less organic modifier than on conventional porous columns, it is possible to separate basic compounds as is shown in the analysis of barbiturates. Most USP methods can be modified to use up to 90% less organic and obtain up to 20 times faster separations. This translates to most drug types including analgesics, β -blockers, antidepressants, vitamins, cough and cold drugs, hormones, antibiotics, derivatives, and sedatives.

Environmental

ODS-I PAH specialty column demonstrates a reproducible and rugged method for the separation of 16 PAHs in less than 8 minutes. The U.S. EPA classifies the compounds as priority pollutants requiring routine monitoring for regulatory administration in drinking water, waste water, and soil using methods 610, SW-846, and 8310.

See Application notes

ORDERING INFORMATION: P-630-963-1481; F-630-963-6432; info@eprogen.com			
MICRA NPS ODS-I Platinum	1.5 μ NPS silica	ODS-I	ODS-I PAH Certified
	<u>Format (mm)</u>	<u>Item Number</u>	<u>Item Number</u>
Mini-bore	33x3.0	0430ODS101.5	Special Request
	53x3.0	0630ODS101.5	Special Request
Fast Analysis	14x4.6	0146ODS101.5	
Standard	33x4.6	0446ODS101.5	0446PAH101.5
	53x4.6	0646ODS101.5	0646PAH101.6
High Capacity	33x8.0	0846ODS101.5	Special Request
ORDERING INFORMATION: P-630-963-1481; F-630-963-6432; info@eprogen.com			

MICRA-Platinum Reversed Phase HPLC columns

NPS ODS-I

Suggested pharmaceutical, life science, and environmental applications for MICRA-Platinum **NPS ODS-I** columns include amino acids, analgesics, antibiotics, barbiturates, benzodiazepines, benzotriazole, β -blocking drugs, catecholamines, epirubicin, explosives, food additives, on-line process monitoring, polynuclear aromatic hydrocarbons, preservatives, steroids, sun screens, tricyclic antidepressants, and water-soluble vitamins.

Barbiturates

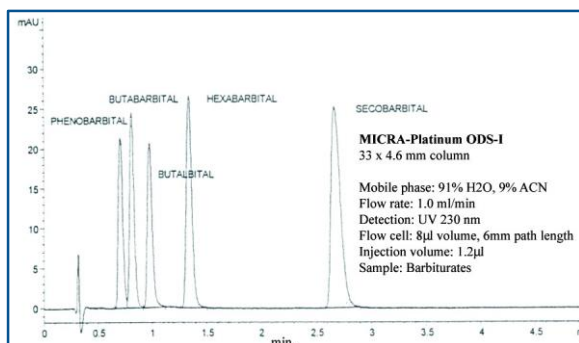

Tryptic Digest of Hemoglobin

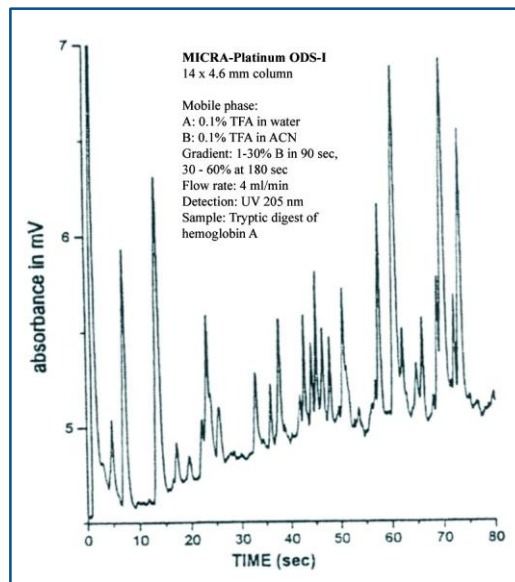

Amino Acids

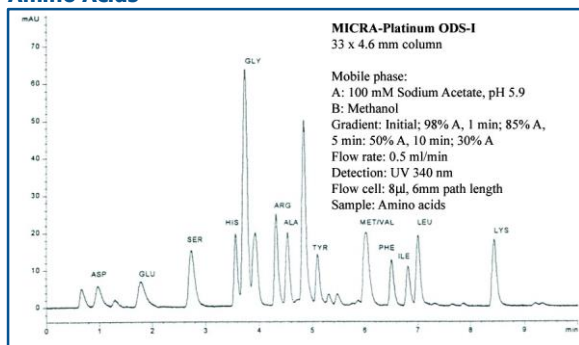

Protein Mixture

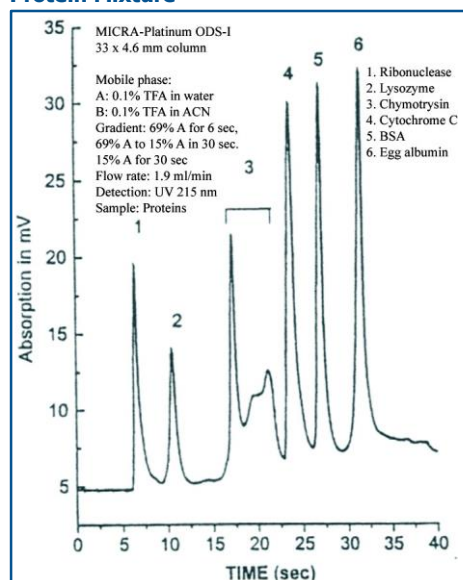

PAH EPA 610 standard

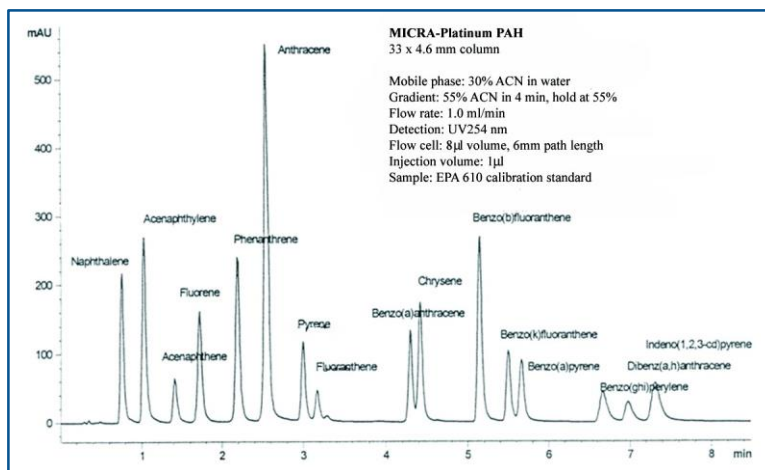

MICRA-Platinum Reversed Phase HPLC columns

NPS ODS-II (HPRP) – The Optimum Protein/Peptide Separator

ODS-II is monomeric bidentate bonded and offers a more hydrophilic surface than the ODS-I phase but less stability due to decreased shielding of the surface silanols. The increase in silanophilic interactions with analytes and mobile phases provides an opportunity to alter selectivity and resolve components that otherwise do not separate on the more shielded ODS-I C-18 polymerically bonded phase. As the ODS-II applications demonstrate, fast separations with high efficiency are obtained with this column technology. The detection of 103 peaks in the tryptic digest of apotransferrin, illustrated below, highlights the excellent resolution and high peak capacity possible with this column. It is the preferred bonded phase for protein and peptide separations.

Artificial Sweeteners

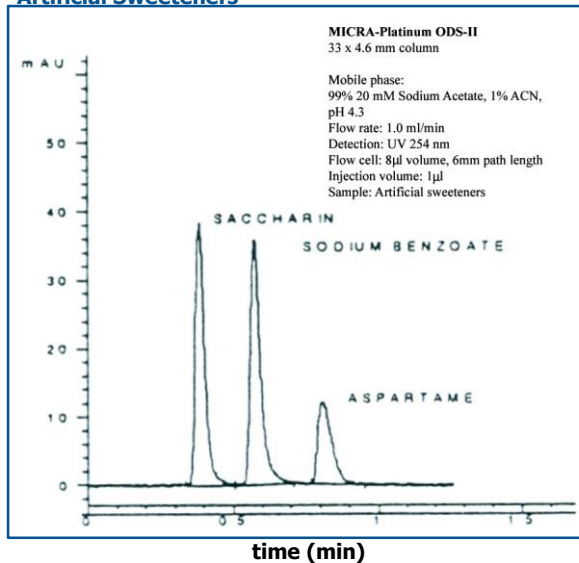

Transferrin Digest

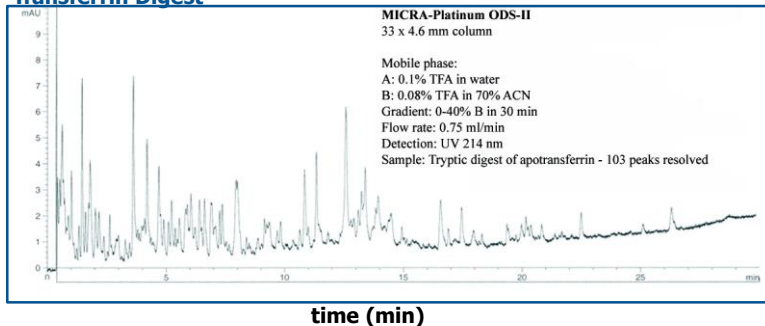

Sunscreens

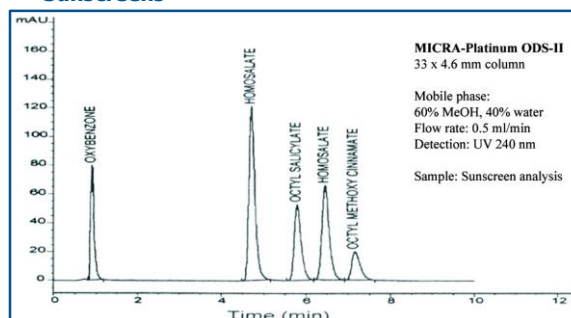

Phthalate Analysis

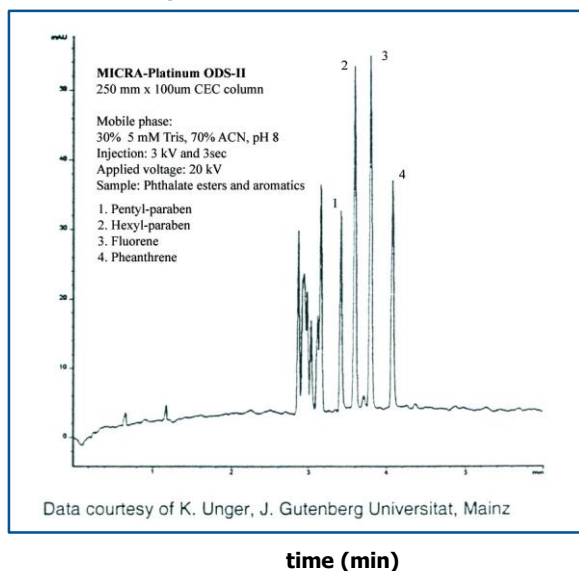

**ORDERING INFORMATION: P-630-963-1481; F-630-963-6432;
info@eprogen.com**

MICRA NPS HPRP Platinum	1.5µ NPS silica	ODS-II
	Format (mm)	Item Number
Mini-bore	33x3.0	0430ODS201.5
	53x3.0	0630ODS201.5
Fast Analysis	14x4.6	0146ODS201.5
Standard	33x4.6	0446ODS201.5
	53x4.6	0646ODS201.5
High Capacity	33x8.0	0846ODS201.5

**ORDERING INFORMATION: P-630-963-1481; F-630-963-6432;
info@eprogen.com**

MICRA-Platinum Reversed Phase HPLC columns

NPS ODS-IIIIE

ODS-IIIIE is an end-capped, monomeric bonding. It is specifically designed for fast analysis and excellent resolution of basic compounds. The most critical factors in this type of analysis are peak shape and column stability. These factors are illustrated below as well as an example of ODS-IIIIE in rapid protein profiling.

Antihistamines

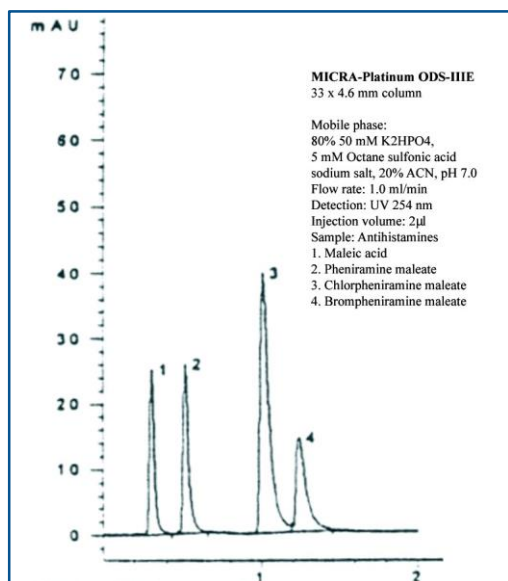

Antiarrhythmics

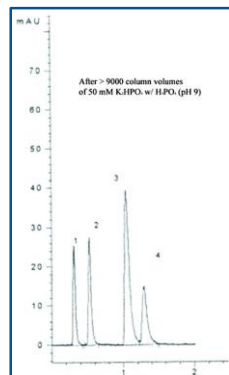
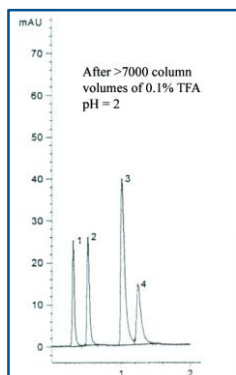
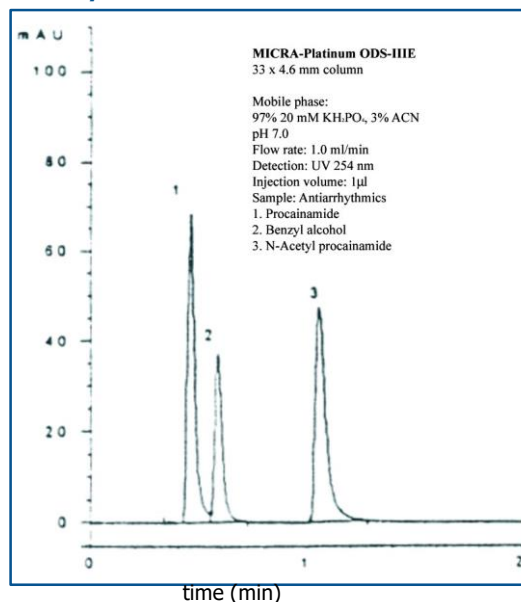

Protein Profiling

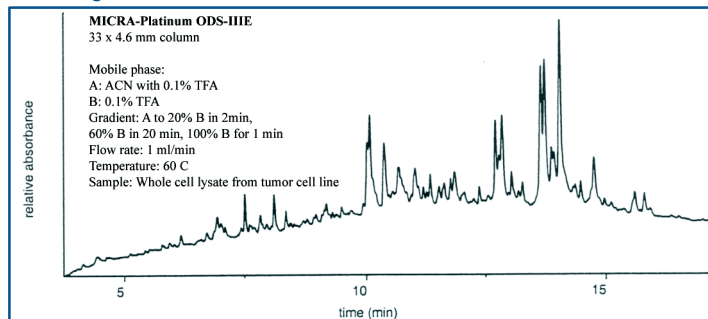

ORDERING INFORMATION: P-630-963-1481; F-630-963-6432; info@eprogen.com

MICRA NPS end-capped Platinum	1.5µm NPS silica	ODS-IIIIE
	Format (mm)	Item Number
Mini-bore	33x3.0	0430ODS3E1.5
	53x3.0	0630ODS3E1.5
Fast Analysis	14x4.6	0146ODS3E1.5
Standard	33x4.6	0446ODS3E1.5
	53x4.6	0646ODS3E1.5
High Capacity	33x8.0	0846ODS3E1.5

ORDERING INFORMATION: P-630-963-1481; F-630-963-6432; info@eprogen.com

MICRA-Platinum Reversed Phase HPLC columns

NPS ODS-TAS: C-30

NPS-TAS is an extended C-30 chain length with a high carbon load for higher resolving power. It is designed for rapid analysis of carotenoids and fast separation of oil soluble vitamins as well as 2,4-DNPH and other DNPH- aldehydes and ketones in air samples. For information is available on this applications by requesting application notes AP20 and AP22.

Carotenoids

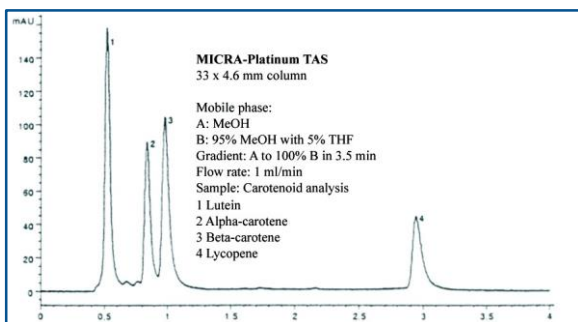

DNPH Aldehydes

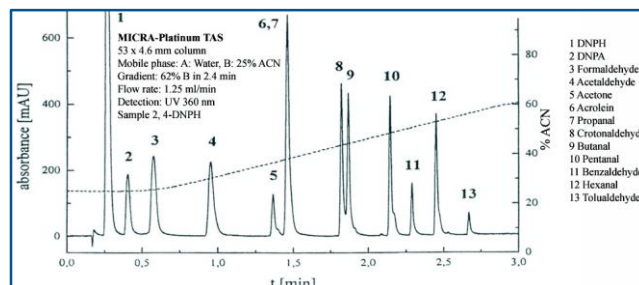

NPS-Sil: Normal Phase

MICRA-Platinum Sil is a non-bonded phase on 1.5µ non-porous spherical silica. **NPS** columns offer increased stability, short run times, high sensitivity, and greatly improved mass transfer. This column is excellent for high throughput and QC lab applications, as well as LC/MS separations. They are highly efficient for all normal phase applications and work particularly well with very polar compounds.

Vitamins A and D

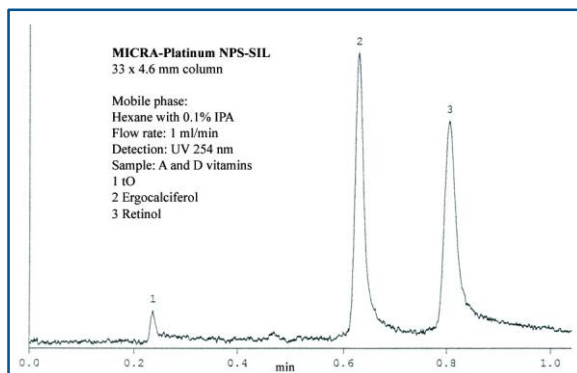

ORDERING INFORMATION: P-630-963-1481; F-630-963-6432; info@eprogen.com

MICRA- NPS – TAS Platinum		ODS-TAS	ODS-Sil
1.5µ NPS silica			
	<u>Format (mm)</u>	<u>Item Number</u>	<u>Item Number</u>
Standard	33x4.6	0446TAS101.5	0446NPS01.5
High Capacity	53x4.6	0646TAS101.5	Special Request
ORDERING INFORMATION: P-630-963-1481; F-630-963-6432; info@eprogen.com			

MICRA-Platinum *NPS* 1.5 μ HPLC Columns

Information & Operating Instructions for Optimum Results

Silica Surface Bonded Phase Descriptions

ODS-I, II, and IIIE have similar surface C-18 ligand densities. ODS-I is more stable in low and high due to increased surface shielding provided by the polymeric surface chemistry. The ODS-II is a monomeric C-18 silane resulting in a more accessible silica surface making it more hydrophilic in nature with improved selectivity between closely related polar components. ODS-III is an end capped version of ODS-II. It provides excellent peak shape and is well suited for basic drug and pharmaceutical analysis. 100% aqueous mobile phases can be used with all *NPS* C-18 phases. The 33x4.6 mm columns yield an approximate plate efficiency of 5000 plates/column on standard LC systems. Column loading capacities is 5000 ng/column. For optimum efficiencies, use injection volumes of 2 μ l.

Particle Size Considerations

Eprogen's 1.5 μ *NPS* columns offer increased speed of analysis, increased resolution of small samples, decreased solvent consumption, and equilibration time savings for routine analytical work. These columns are compatible with conventional equipment, however, a t_0 of <0.35ml is recommended best results. Due to the smaller surface area, total carbon load on the *NPS* C-18 columns is approximately 6%. Additionally, the smaller particle size results in typical operating pressures of 250 bar at 1.0ml/min flow rates (50% water/50% ACN) for the 33x4.6mm columns. The column void volume of a standard 5 μ porous column is 70% of the empty column volume and the column void volume of these *NPS* columns is 30% of the empty column volume. The highly uniform sphere size provides for minimum channeling, improved reproducibility, low column dead volume, flat van Deemter plot, and higher stability. Typical bare silica properties are as follows; Fe <5ppm, Ca <10ppm, K <10ppm, Na < 10ppm, Al <10ppm, surface area <3m²/g, density 2.0g/ml, % residual carbon <1000 mass ppm, % residual nitrogen <1000 mass ppm.

Mobile Phase Instructions

- Mobile phase should be filtered through a 0.2 μ filter prior to use.
- HPLC water with less than 20% organic must be changed daily.
- Ensure constant temperatures throughout the analysis.
- Start with 1/3 the amount of organic modifier compared to a standard porous column.
- Typical flow rates are 0.5 to 1.5ml/min.
- Minimum equilibration volume is 2.75ml.
- Keep mobile phase buffers between a pH of 2-9, ODS-I columns can tolerate a pH of 10.

Hardware and Detector Instructions

For routine analysis, excellent results can be obtained with flow cells of 15 μ l or less. Use 0.010 I.D or smaller tubing connections between injector and detector to minimize dispersion effects. If using RI detectors, minimum heat exchanger volumes are needed for use with column. Use a precolumn filter between the injector and column inlet. DO NOT use a guard column.

Storage and Usage

Reversed phase columns are shipped in 20% ACN. Before storing, rinse columns with water followed by methanol or acetonitrile. Storage solvents should contain at least 20% organic. Avoid storage at a pH greater than 7 and less than 5.

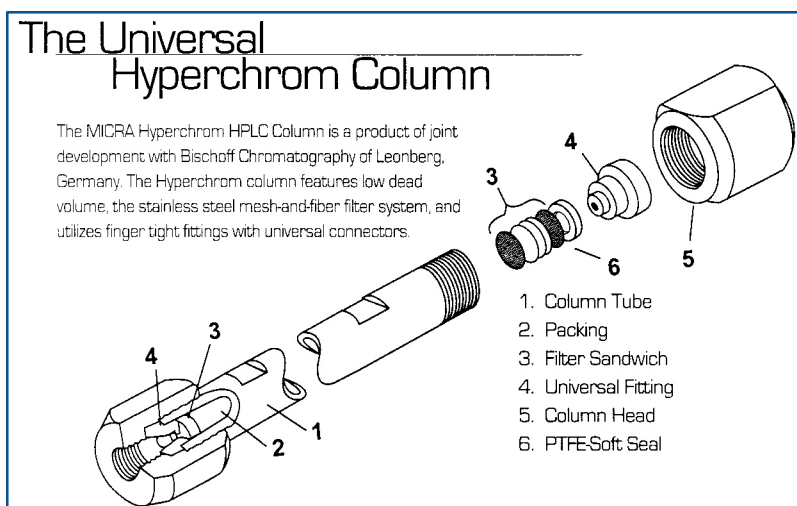

MICRA-Platinum Reversed Phase HPLC columns

NPS Applications in LC/MS

MICRA **NPS** technology provides the opportunity for a new TOF-based LC-MS system which rapidly resolves and identifies the individual components present while maintaining high peak capacity.

A Fast LC-ESI/MS analysis of herbicides using **NPS** ODS-I has been developed by American Cyanamid Co., Princeton, NJ. For additional information on these procedures, request application notes and AP14, AP21, and/or reference the article: **Rapid Peptide Mapping by RP-LC on Non-Porous Silica with On-Line Electrospray Time-of-Flight Mass Spectrometry**, Banks J. F. and Gulciek E., Anal. Chem., 69, (19), 3973-8, (1997).

Fast LC separation of peptides

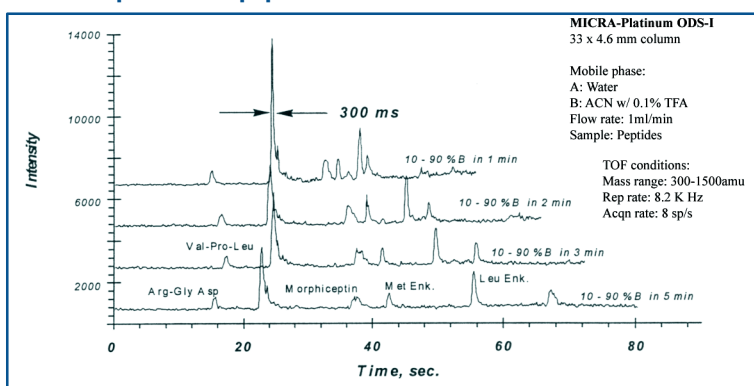

Mass Spectra of the Individual peptides

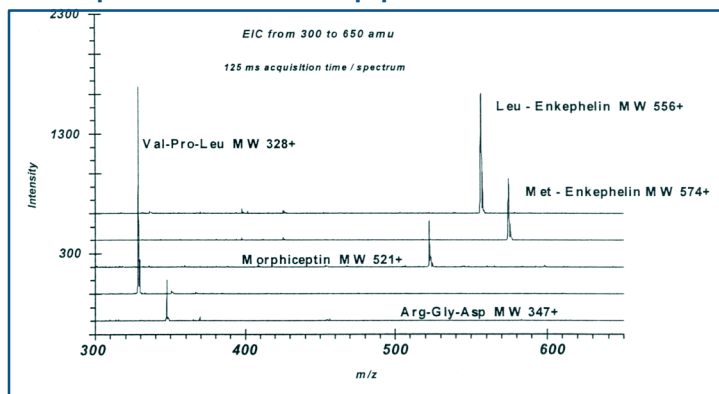

LCMS-Herbicides

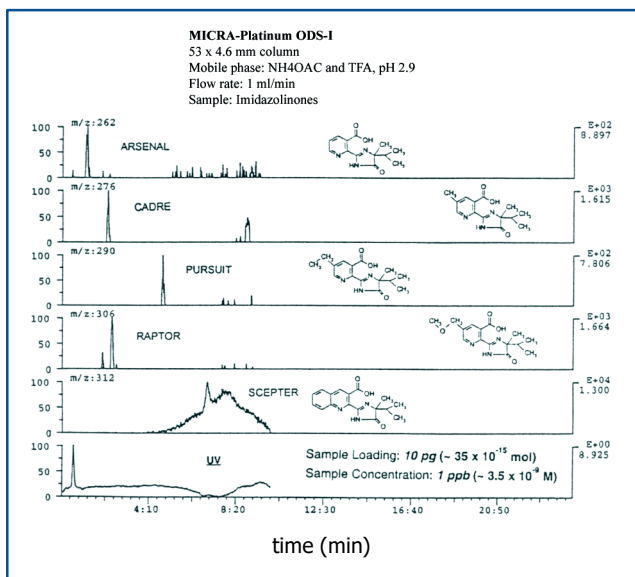

LCMS-Tryptic Digest

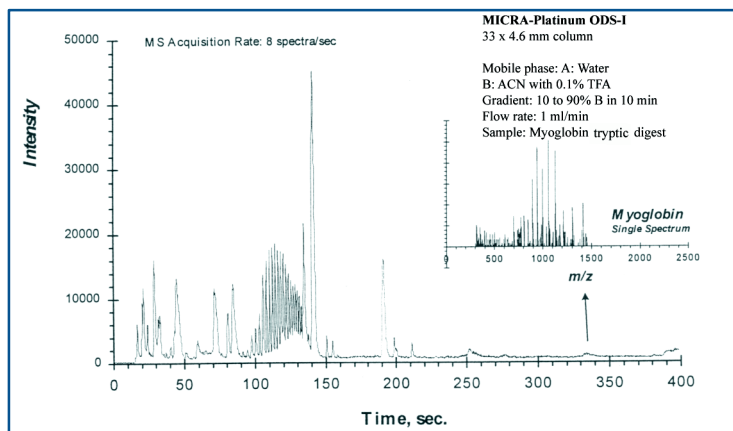

All NPS columns are compatible with the current UPLC systems and can be used up to 10,000 psi

MICRA-Platinum Reversed Phase HPLC columns

3 μ , 100 \AA , porous silica: short chain base-deactivated, SCD-MS phase

SCD-MS is a short chain base-deactivated support designed for drug mixtures. These columns combine the unique selectivity of the SynChropak SCD-100 bonded phase with 3 μ particles, in a small column format ideal for fast MS applications. The SCD unique base deactivation produces excellent peak shape for drugs with high pK_a values. The lower level of hydrophobicity decreases the amount of organic modifier needed.

Analgesics

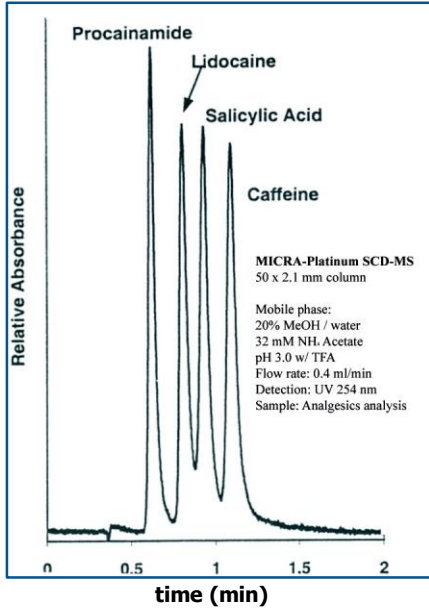

Diazepines

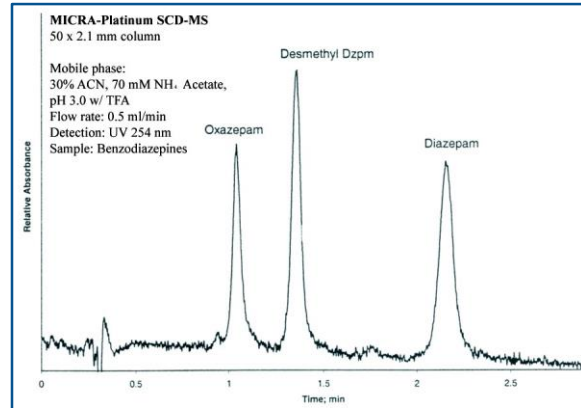

TCA analysis

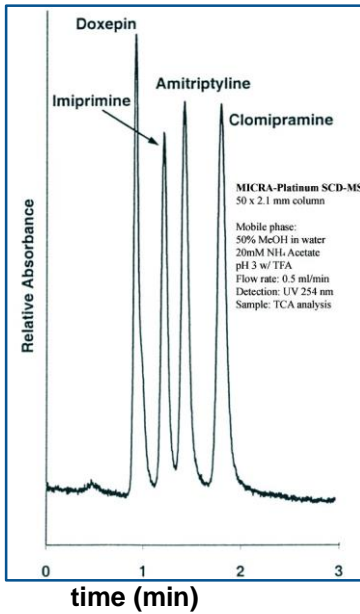

**ORDERING INFORMATION: P-630-963-1481; F-630-963-6432;
info@eprogen.com**

MICRA-Platinum SCD-MS; 100 \AA , 3 μ		
LC-MS	Format (mm)	Item Number
	50x2.1	MB2SCD100-3-5
Standard	50x4.6	SCD100-3-5
	100x4.6	CSCD100-3-10
	150x4.6	CSCD100-3-15
Standard Guard	33x4.6	FSCD100-3-3

**ORDERING INFORMATION: P-630-963-1481; F-630-963-6432;
info@eprogen.com**

MICRA-Gold Specialty Reversed Phase HPLC Column

C-4 Bonding

The monomeric bonded, non-end capped, C-4 supports are a popular choice for protein and peptide separations, especially for large hydrophobic solutes due to their excellent recovery.

MICRA-Gold RP4

5 μ , 300 \AA , Spherical silica

This 300 \AA pore size is optimal for the loading and high resolution of peptides.

MICRA-Gold RP4-4000

10 μ , 4000 \AA , Spherical silica

This 4000 \AA support is especially popular for very large hydrophobic solutes. It delivers high speed analysis and excellent sample recovery.

MICRA-Gold Reversed Phase Columns exhibit high stability and excellent resolution. Suggested applications include amino acids, nucleotides, peptides, and proteins.

Protein Digest

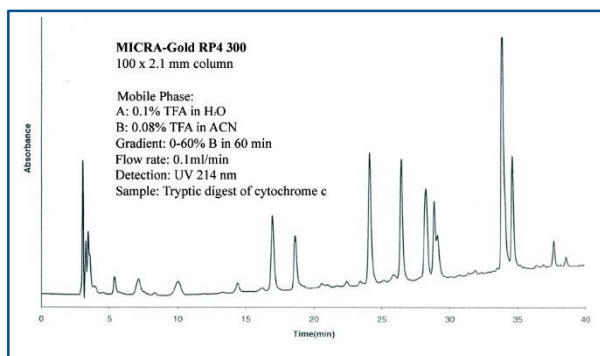

Protein Mixture

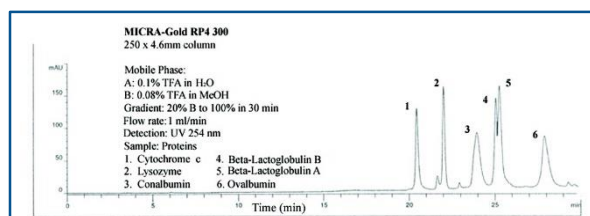

<u>Pore size</u>	<u>Optimum MW</u>	<u>Surface area</u>
100 \AA	<2,000	250m ² /g
300 \AA	<70,000	100m ² /g
1000 \AA	<300,000	20m ² /g
4000 \AA	<1000,000	6m ² /g

ORDERING INFORMATION: P-630-963-1481; F-630-963-6432; info@eprogen.com

MICRA-Gold Reversed Phase HPLC Columns		RP4-300	RP4-4000
		300 \AA , 5 μ	4000 \AA , 10 μ
	<u>Format (mm)</u>	<u>Item Number</u>	<u>Item Number</u>
Narrow-bore	100x2.1	MB2C4RG103-10	MB2C4R140-10
	250x2.1	MB2C4RG103-25	MB2C4R140-25
	Narrow-bore Guard	50x2.1	MB2FC4RG103-5
Standard	50x4.6	C4RG103-5	C4R140-5
	100x4.6	C4RG103-10	C4R140-10
	250x4.6	C4RG103-25	C4R140-25
Standard Guard	33x4.6	FC4RG103-3	FC4R140-3
	53x4.6	FC4RG103-5	FC4R140-5

ORDERING INFORMATION: P-630-963-1481; F-630-963-6432; info@eprogen.com

MICRA-Gold Specialty Reversed Phase HPLC Column

MICRA-Gold SCD

5 μ , 100Å, Spherical silica

This uniquely deactivated reversed phase support is bonded with a short alkyl chain ligand and is end-capped. Excellent peak shapes are obtained for many drug mixtures without the addition of silanol suppressing agents. MICRA-Gold SCD is ideal for the analysis of positively charged molecules, as well as neutral and acidic molecules.

Drug Mixture

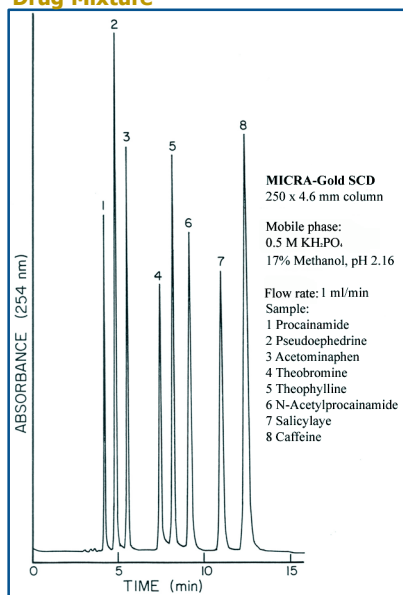

Pyrimidines

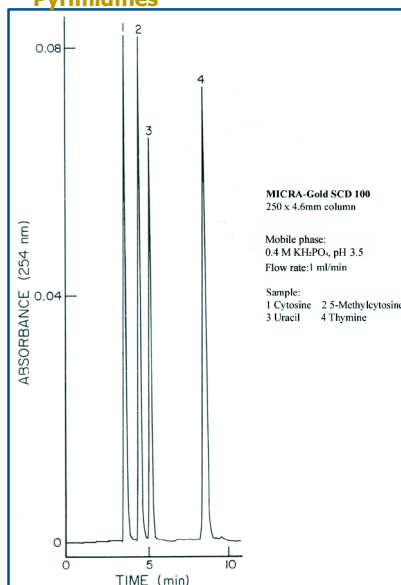

ORDERING INFORMATION: P-630-963-1481; F-630-963-6432; info@eprogen.com		
MICRA-Gold Reversed Phase HPLC Columns		SCD-100
		100Å, 5 μ
	Format (mm)	Item Number
Narrow-bore	100x2.1	MB2SCD100-10
	250x2.1	MB2SCD100-25
Narrow-bore Guard	50x2.1	MB2FSCD100-5
Standard	100x4.6	SCD100-10
	150x4.6	SCD100-15
	250x4.6	SCD100-25
Standard Guard	33x4.6	FSCD100-3
	53x4.6	FSCD100-5

ORDERING INFORMATION: P-630-963-1481; F-630-963-6432; info@eprogen.com

MICRA-Gold Cation Exchange HPLC Columns

MICRA-Gold Cation exchange columns exhibit excellent resolution, high loading capacity, compatibility with nonionic detergents and organic solvents, and offer high recovery of biological activity. Suggested applications include proteins, enzymes, nucleotides, peptides, hemoglobins, and catecholamines.

WCX

MICRA-Gold CM100

5 μ , 100Å, Spherical Silica

This weak cation exchanger has a polyamide coating containing carboxymethyl groups and is compatible with aqueous and many organic solvents in the pH range of 2-8. Selectivity can be altered by mobile phase salt composition and pH which affects ionization of both the support and the solute. This support is a superb choice for the separation of small cationic compounds such as catecholamines.

Catecholamines

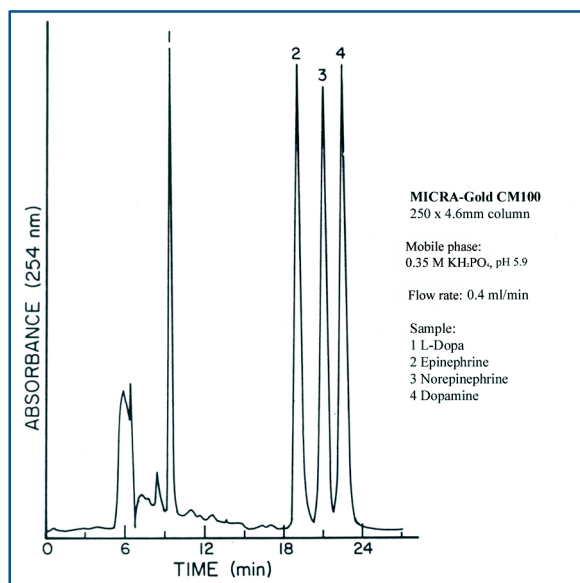

SCX

MICRA-Gold S1000

7 μ , 1000Å, Spherical Silica

This strong cation exchanger has a polyamide coating containing sulfonic acid functional groups. It is compatible with aqueous and many organic solvents in the pH range of 2-8. Ionization of just the solute is affected by pH above 3. This is an excellent column for the fast analysis of glycosylated hemoglobins.

Hemoglobin

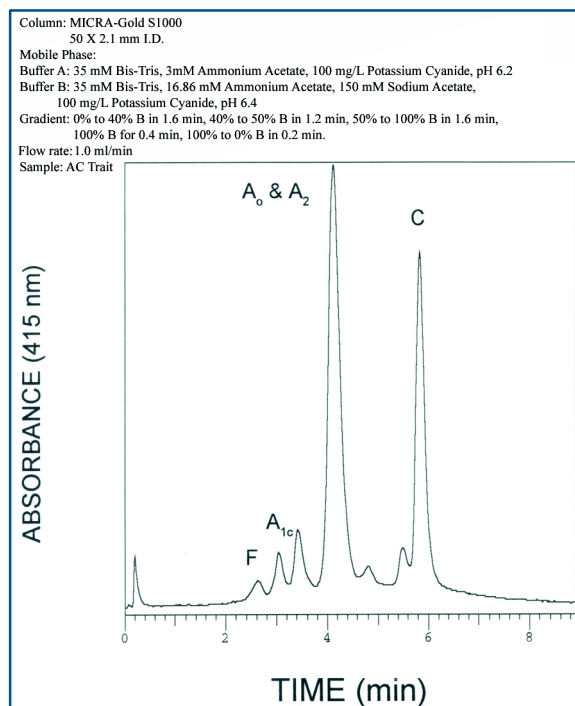

CM (WCX) Specifications for Solute Interaction

Pore Size	MW (Da)	Surface Area	Loading Capacity	I.E. Capacity
100Å	<10,000	250 m ² /g	34 mg/ml	65 mg hemoglobin per gm support

MICRA-Gold Cation Exchange HPLC Columns

ORDERING INFORMATION: P-630-963-1481; F-630-963-6432; info@eprogen.com

MICRA-Gold Cation Exchange HPLC Columns		CM 100	S 1000
		100Å, 5µ	1000Å, 7µ
	<u>Format (mm)</u>	<u>Item Number</u>	<u>Item Number</u>
Narrow-bore	50x2.1		MB2CS110-5
	100x2.1	MB2CCM101-10	MB2CS110-10
	250x2.1	MB2CCM101-25	MB2CS110-25
Narrow-bore Guard	50x2.1	MB2FCCM101-5	MB2FCS110-5
Standard	100x4.6	CCM101-10	CS110-10
	250x4.6	CCM101-25	CS110-25
Standard Guard	33x4.6	FCCM101-3	FCS110-3
	53x4.6	FCCM101-5	FCS110-5
Semi-Prep	250x7.8	SPCCM101-25	SPCS110-25
	250x10	PCCM101-25	PCS110-25
Semi-Prep Guard	50x7.8	SPFCCM101-5	SPFCS110-5
	50x10	PFCCM101-5	PFCS110-5
ORDERING INFORMATION			

MICRA-Gold Anion Exchange HPLC Columns

ORDERING INFORMATION

MICRA-Gold Anion Exchange HPLC Columns		AX 100	AX 1000	Q 100
		100Å, 5µ	1000Å, 7µ	100Å, 5µ
	<u>Format (mm)</u>	<u>Item Number</u>	<u>Item Number</u>	<u>Item Number</u>
Narrow-bore	100x2.1	MB2CA101-10	MB2CA110-10	MB2CQ101-10
	250x2.1		MB2CA110-25	MB2CQ101-25
Narrow-bore Guard	50x2.1	MB2FCA101-5	MB2FCA110-5	MB2FCQ101-5
Standard	100x4.6	CA101-10	CA110-10	CQ101-10
	250x4.6	CA101-25	CA110-25	CQ101-25
Standard Guard	33x4.6	FCA101-3	FCA110-3	FCQ101-3
	53x4.6	FCA101-5	FCA110-5	FCQ101-5
Semi-Prep	250x7.8	SPCA101-25	SPCA110-25	SPCQ101-25
	250x10	PCA101-25	PCA110-25	PCQ101-25
Semi-Prep Guard	50x7.8	SPFCA101-5	SPFCA110-5	SPFCQ101-5
	50x10	PFCA101-5	PFCA110-5	PFCQ101-5
ORDERING INFORMATION: P-630-963-1481; F-630-963-6432; info@eprogen.com				

MICRA-Gold Anion Exchange HPLC Columns

WAX

MICRA-Gold AX100

5 μ , 100Å, Spherical silica

This weak anion exchanger is a crosslinked polyethyleneimine support compatible with aqueous and many organic solvents in the pH range of 2-8. Selectivity can be altered by mobile phase composition and pH which affects ionization of both the support and the solute. This 100Å support provides a high surface area for the separation of small molecules. It provides excellent separations of peptides, nucleotides, acidic molecules and oligonucleotides of up to 30 residues.

MICRA-Gold AX1000

7 μ , 1000Å, Spherical silica

This weak anion exchanger is a crosslinked polyethyleneimine phase compatible with aqueous and many organic solvents in the pH range of 2-8. Selectivity can be altered by mobile phase composition and pH affects ionization of both the support and the solute. It is particularly well suited for the separation of proteins larger than 200,000 Daltons such as estrogen receptor isoforms.

SAX

MICRA-Gold Q100

5 μ , 100Å, Spherical silica

Q100 is a strong anion exchange quaternized crosslinked polyethyleneimine support. It is compatible with aqueous and many organic solvents in the pH range of 2-8. Ionization of this support has no pH dependence. This 100Å packing material is an excellent choice for the rapid separation of peptides, small proteins and small anionic particles such as nucleotides.

Oligodeoxyadenylic Acid

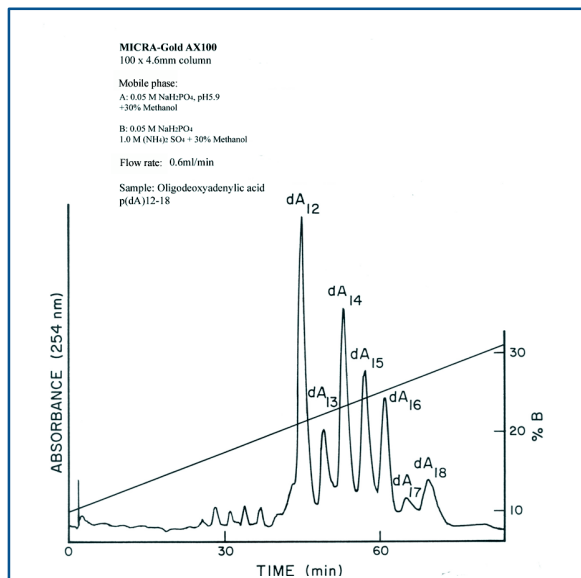

Organic Acids

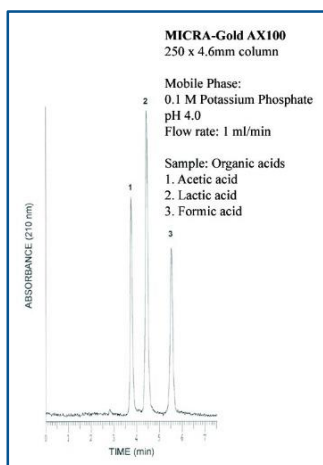

Estrogen Receptor Isoforms

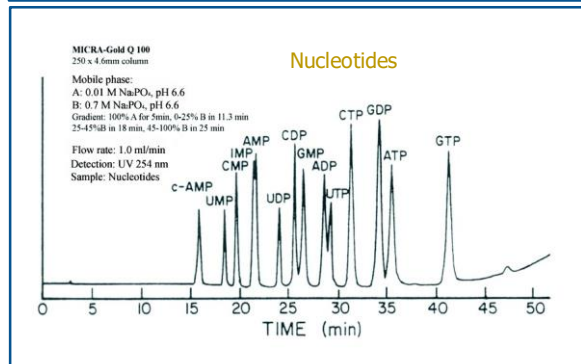
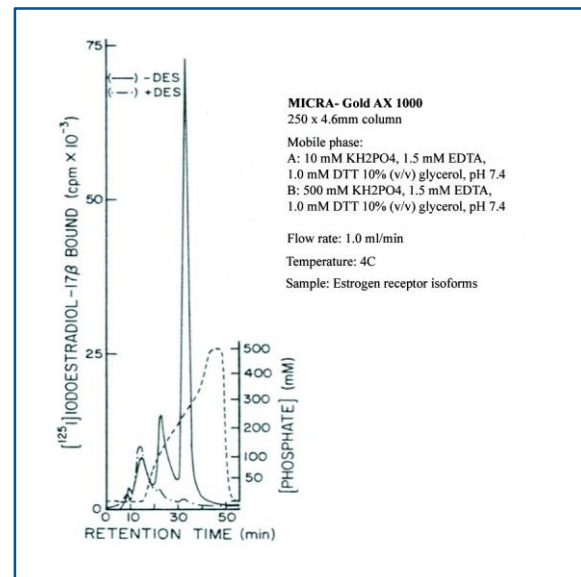

MICRA-Gold Anion Exchange columns exhibit excellent resolution, high loading capacity, and compatibility with nonionic detergents and organic solvents. Suggested applications include proteins enzymes, nucleotides, and receptor purifications.

MICRA-Gold Size Exclusion (GPC) HPLC Columns

The MICRA-Gold GPC series is derived from a glycerol bonded size exclusion support. Products are offered in seven pore diameters (50Å – 4000Å). This diversity in pore size allows for the analysis of solutes with molecular weights ranging from 0.5 kDa to 10,000 kDa. These supports have minimal interaction with anionic and neutral water-soluble polymers.

Pore sizes ranging from 100Å to 500Å are popular for the rapid analysis of proteins and smaller water-soluble polymers.

MICRA-Gold GPC100

5μ, 100Å

Appropriate for globular molecules with MW ranges from 5-160 kD and linear molecules with MW ranges from 0.5-25 kD.

MICRA-Gold GPC300

5μ, 300Å

Appropriate for globular molecules with MW ranges from 10-1000 kD and linear molecules with MW ranges from 2-100 kD.

MICRA-Gold GPC500

7μ, 500Å

Appropriate for globular molecules with MW ranges from 40-2000 kD and linear molecules with MW ranges from 10-350 kD.

For effectively analyzing very large polymers by size use the 1000Å or 4000Å pore size.

MICRA-Gold GPC1000

7μ, 1000Å

GPC1000 is most frequently used with linear molecules possessing MW ranges from 40-1000 kD. It also allows for the separation of globular molecules such as protein multimers with MW ranges from 40-1,000 kD.

MICRA-Gold GPC4000

10μ, 4000Å

This 4000Å support is appropriate for linear molecules possessing MW ranges from 70-10,000 kD

ORDERING INFORMATION: P-630-963-1481; F-630-963-6432; info@eprogen.com						
MICRA-Gold GPC Size Exclusion HPLC Columns		GPC100 100Å, 5μ	GPC300 300Å, 5μ	GPC500 50Å, 7μ	GPC1000 1000Å, 7μ	GPC4000 4000Å, 10μ
	Format (mm)	Item Number	Item Number	Item Number	Item Number	Item Number
Standard	250x4.6	CG101-25	CG103-25	CG105-25	CG110-25	CG140-25
Standard Guard	50x4.6	FCG101-5	FCG103-5	FCG105-5	FCG110-5	FCG140-5
Semi-Prep	300x7.8	SPCG101-30	SPCG103-30	SPCG105-30	SPCG110-30	SPCG140-30
	250x10	PCG101-25	PCG103-25	PCG105-25	PCG110-25	PCG140-25
Semi-Prep Guards	50x7.8	SPFCG101-5	SPFCG103-5	SPFCG105-5	SPFCG110-5	SPFCG140-5
	50x10	PFCG101-5	PFCG103-5	PFCG105-5	PFCG110-5	PFCG140-5
ORDERING INFORMATION: P-630-963-1481; F-630-963-6432; info@eprogen.com						

Suggested applications for Eprogen's MICRA-Gold GPC series include:

- Peptides, proteins, carbohydrates, nucleic acids, anionic polymers, and neutral polymers.
- MICRA-Gold GPC offers excellent resolution while maintaining biological activity.
- The columns are compatible with aqueous solvents (pH 2-8), surfactants, and many organic solvents including dimethylformamide, tetrahydrofuran and ethanol.

Protein Mixture

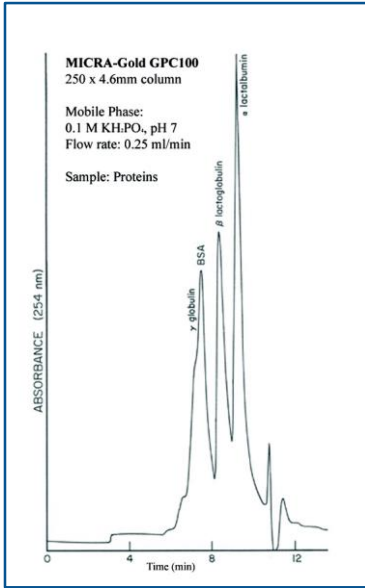

Protein Mixture

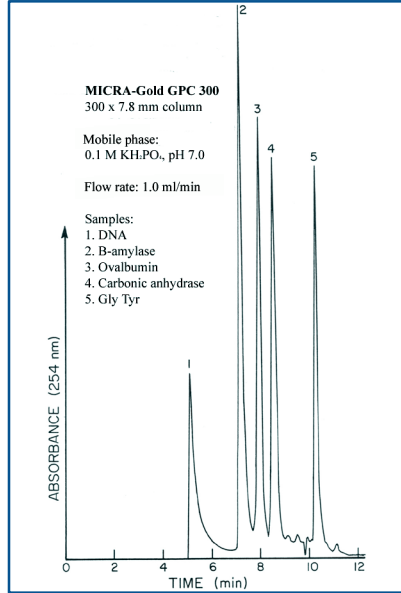

Viral Coat Protein

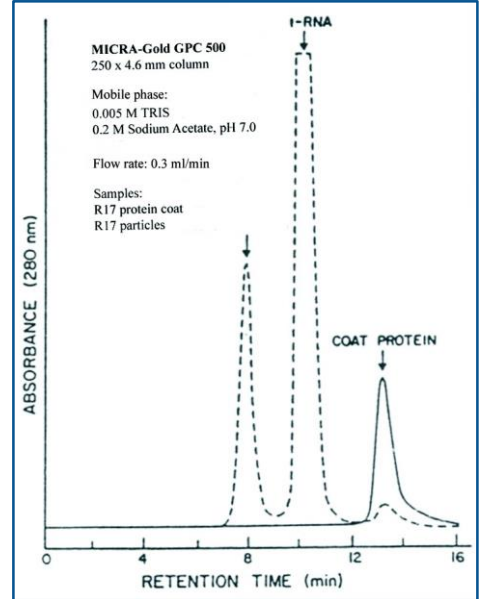

Polymer Mixture

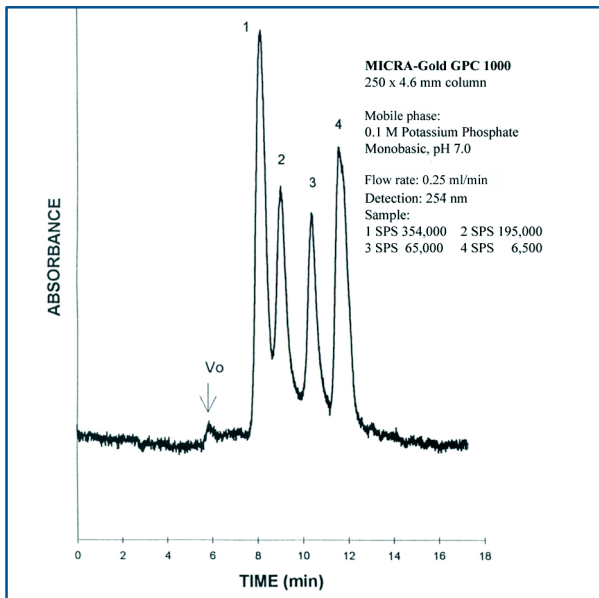

Globular Molecules Calibration Curves

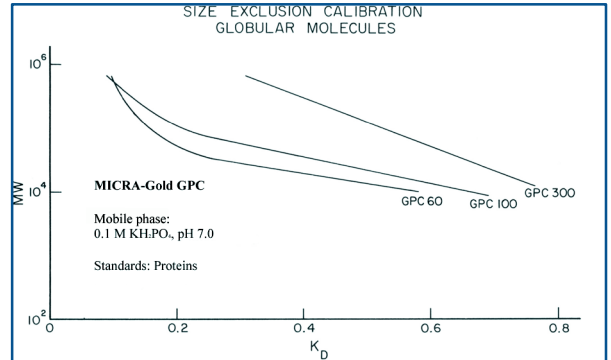

Linear Molecules Calibration Curves

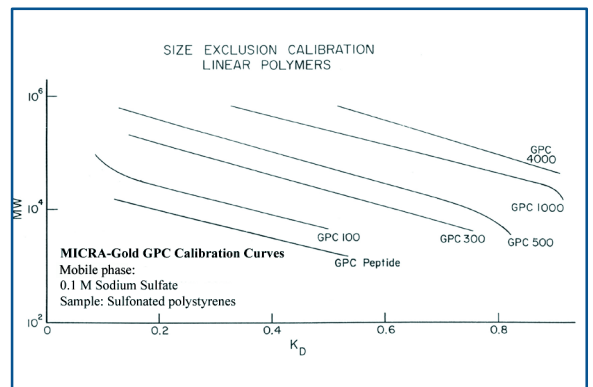

GPC column selection guide for MW range separations.

Globular Molecules & Proteins	MW Range (Da)	Linear Molecules & Polymers	MW Range (Da)
GPC Peptide	8.0 x 10 ² to 3.5 x 10 ⁴	GPC Peptide	5.0 x 10 ² to 1.0 x 10 ⁴
GPC100	5.0 x 10 ³ to 1.6 x 10 ⁵	GPC100	5.0 x 10 ² to 2.5 x 10 ⁴
GPC300	1.0 x 10 ⁴ to 1.0 x 10 ⁶	GPC300	2.0 x 10 ³ to 1.0 x 10 ⁵
GPC500	4.0 x 10 ⁴ to 1.0 x 10 ⁶	GPC500	1.0 x 10 ⁴ to 3.5 x 10 ⁵
GPC1000	4.0 x 10 ⁵ to 1.0 x 10 ⁷	GPC1000	4.0 x 10 ⁴ to 1.0 x 10 ⁶
		GPC4000	7.0 x 10 ⁴ to 1.0 x 10 ⁷
		GPC Linear	1.0 x 10 ³ to 1.0 x 10 ⁶

MICRA-Gold Size Exclusion

Specialty CATSEC (Cationic-polymer) HPLC Columns

Unique to Eprogen are the MICRA-Gold CATSEC series of SEC supports made specifically for analysis of cationic polymers.

The polymerized polyamine coating enables polymers such as polyvinylpyridines to elute according to size and without adsorption. Mobile phases are generally acidic and contain 0.1-0.2M salt to minimize adsorption and ion-exclusion. Pore diameters for these supports are available in the range of 100Å-4000Å allowing analysis of solutes with MWs from 0.5 kDa to 10,000 kDa.

MICRA-Gold CATSEC 100 100Å, 5µ.

This support is appropriate for separating linear molecules with molecular weight ranges of 0.5-25 kDa.

MICRA-Gold CATSEC 300 300Å, 5µ

The 300Å support is appropriate for linear molecules with a MW range of 2-100 kDa.

MICRA-Gold CATSEC 1000 1000Å, 7µ

Designed specifically for high molecular weight ranges, this support is appropriate for MW ranges of 40-1,000 kDa.

MICRA-Gold CATSEC 4000 4000Å, 10µ

CATSEC 4000 is appropriate for high molecular weight ranges of 70-10,000 kDa.

CATSEC 50Å and 500Å bondings are available by special order

ORDERING INFORMATION: P-630-963-1481; F-630-963-6432; info@eprogen.com					
MICRA-Gold CATSEC HPLC Columns		CATSEC100	CATSEC300	CATSEC1000	CATSEC4000
		100Å, 5µ	300Å, 5µ	1000Å, 7µ	4000Å, 10µ
	<u>Format (mm)</u>	<u>Item Number</u>	<u>Item Number</u>	<u>Item Number</u>	<u>Item Number</u>
Standard	250x4.6	CCS201-25	CCS203-25	CCS210-25	CCS240-25
Standard Guard	33x4.6	FCCS201-3	FCCS203-3	FCCS210-3	FCCS240-3
	53x4.6	FCCS201-5	FCCS203-5	FCCS210-5	FCCS240-5
Semi-Prep	300x7.8	SPCCS201-30	SPCCS203-30	SPCCS210-30	SPCCS240-30
	250x10	PCCS201-25	PCCS203-25	PCCS210-25	PCCS240-25
Semi-Prep Guard	50x7.8	SPFCCS201-5	SPFCCS203-5	SPFCCS210-5	SPFCCS240-5
	50x10	PFCCS201-5	PFCCS203-5	PFCCS210-5	PFCCS240-5
ORDERING INFORMATION: P-630-963-1481; F-630-963-6432; info@eprogen.com					

Specialty CATSEC (Cationic-polymer) HPLC Columns

Suggested applications for Eprogen's unique CATSEC columns include SEC of cationic charged polymers and analysis of basic proteins.

CATSEC Calibration Curves

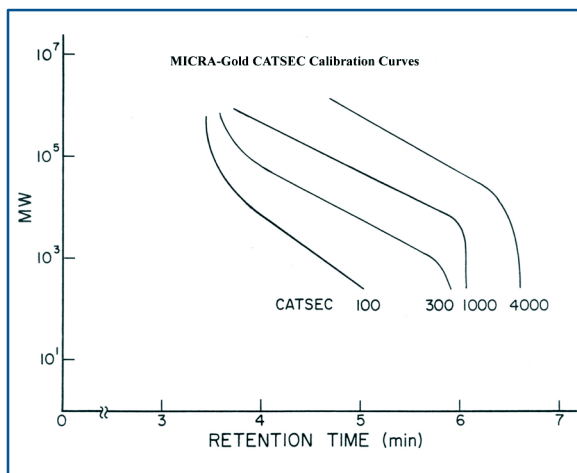

Polyvinylpyridines

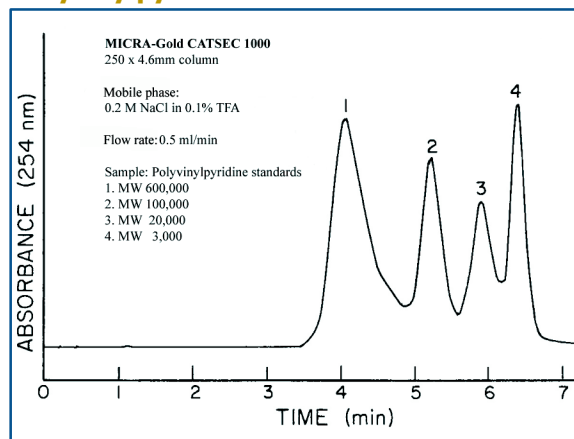

Basic Proteins

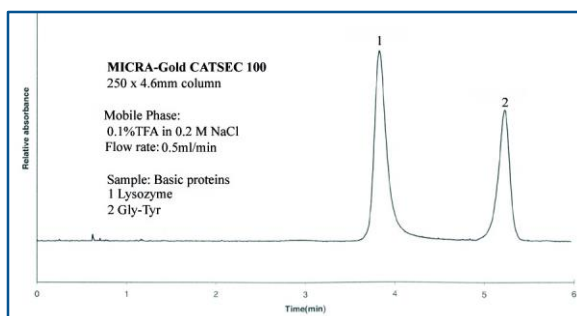

Polyvinylpyridines

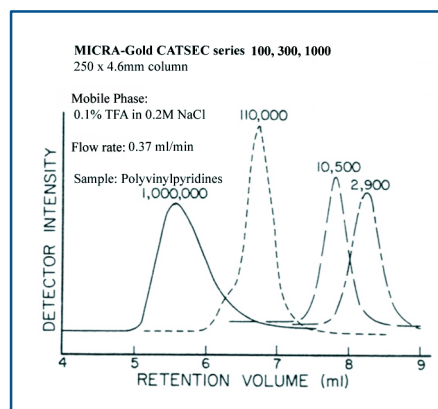

Specialty GPC PEP & GPC Linear HPLC Columns

MICRA-Gold GPC PEP (Peptide)

50Å, 5µ

This is a glycerol bonded size exclusion support which can resolve small peptides (MW 0.8-30 kD). It is successful in resolving peptides which have at least a two-fold MW difference. Mobile phase optimization may be necessary due to the high variability in solubility, charge, and hydrophobicity of peptides. GPC Peptide also works well as a "desalting column". The exclusion limit for GPC Peptide makes it an effective column for rapid desalting of protein or buffer exchange samples, particularly in the 100mm length format.

MICRA-Gold GPC Linear

100Å/1000Å, 7µ

GPC Linear is a glycerol bonded size exclusion support with a mixed pore distribution allowing analysis of samples with a broad range of molecular weights. This support, designed to effectively analyze samples by size, has minimal interaction with anionic and neutral water-soluble polymers. It is appropriate for organic polymers and denatured proteins possessing MW ranges from 1-1000 kD.

Peptide Standards

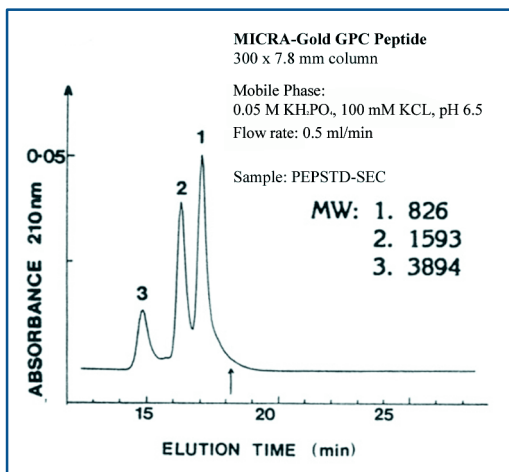

GPC Linear Calibration Curves

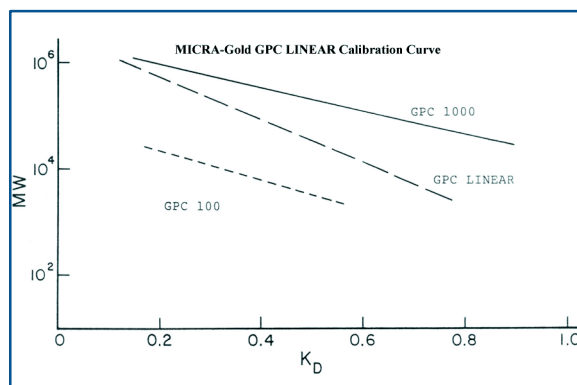

Polymer Mixture

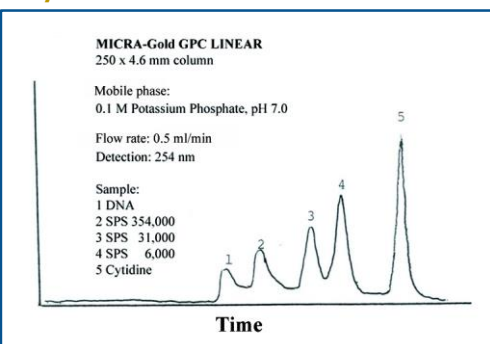

ORDERING INFORMATION

MICRA-Gold Size Exclusion GPC PEP and GPC LINEAR HPLC Columns	GPC PEPTIDE	GPC LINEAR	
	50Å, 5µ	100Å, 5µ	1000Å, 7µ
	<u>Format (mm)</u>	<u>Item Number</u>	<u>Item Number</u>
Standard	100x4.6	CGPEP-10	CG111-10
	250x4.6	CGPEP-25	CG111-25
Standard Guard	50x4.6	FCGPEP-5	FCG111-5
Semi-Prep	300x7.8	SPCGPEP-30	SPCG111-30
	100x10	PCGPEP-10	SPCG111-10
	250x10	PCGPEP-25	PCG111-25
Semi-Prep Guard	50x7.8	SPFCGPEP-5	SPFCG111-5
	50x10	PFCGPEP-5	PFCG111-5

ORDERING INFORMATION

MICRA-Silver Reverse-Phase HPLC Columns

MICRA-Silver RP8; 6.5 μ , 300 \AA , Spheroidal silica

RP8 is a monomerically bonded, non-end capped, support with a C8 ligand. As the carbon chain length has little effect on selectivity in reversed phase chromatography of peptides and proteins, MICRA-Silver RP8 is suited for separating smaller proteins and peptides, especially those of a less hydrophobic nature.

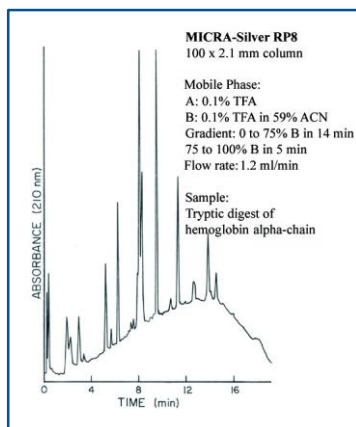

Tryptic Digest of Hemoglobin

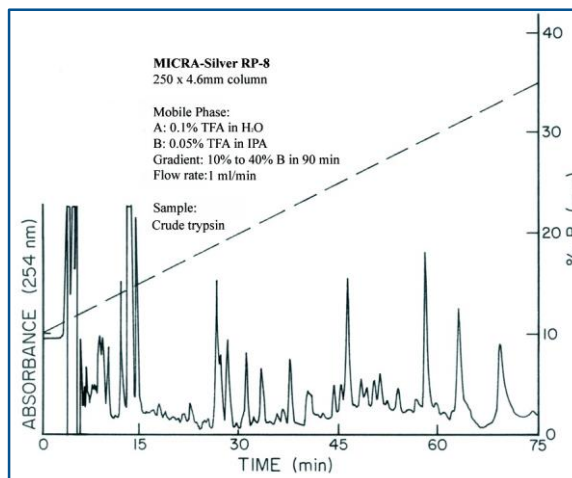

Crude Trypsin

Suggested Applications for MICRA-Silver Reversed Phase Columns Include: proteins, peptides, oligonucleotides, glycoproteins, antibodies, peptide hormones, insulin variants, tryptic digests, biopolymers, membrane proteins, and ribosomal proteins.

ORDERING INFORMATION: P-630-963-1481; F-630-963-6432; info@eprogen.com

MICRA-Silver Reversed Phase HPLC Columns		RP8
		300 \AA , 6.5 μ
	<u>Format (mm)</u>	<u>Item Number</u>
Narrow-bore	100x2.1	MB2C8R103-10
	250x2.1	MB2C8R103-25
Narrow-bore Guard	50x2.1	MB2FC8R103-5
Standard	100x4.6	C8R103-10
	250x4.6	C8R103-25
Standard Guard	33x4.6	FC8R103-3
	53x4.6	FC8R103-5
Semi-Prep	250x10	PC8R103-25
Semi-Prep Guard	50x10	PFC8R103-5

ORDERING INFORMATION: P-630-963-1481; F-630-963-6432; info@eprogen.com

MICRA-Silver Ion Exchange HPLC Columns

MICRA-Silver Anion Exchange HPLC Columns

MICRA-Silver AX300

6.5 μ , 300 \AA , Spheroidal silica

This weak anion exchanger is a crosslinked polyethyleneimine support. It is compatible with aqueous and many organic solvents in the pH range of 2-8. Selectivity can be altered by mobile phase composition and pH which affects ionization of both the support and the solute. AX300 permits analysis of proteins with MWs up to 200,000 Da. AX300 has excellent recoveries and loading capacity. For example, 22mg ovalbumin can be loaded onto a 250x4.6 column with no overloading effects. Chromatofocusing can also be performed on AX300 due to its broad titration curves and high buffering capacity.

Chromatofocusing can also be performed on AX300 due to its broad titration curves and high buffering capacity.

Chromatofocusing can also be performed on AX300 due to its broad titration curves and high buffering capacity.

Protein Mixture

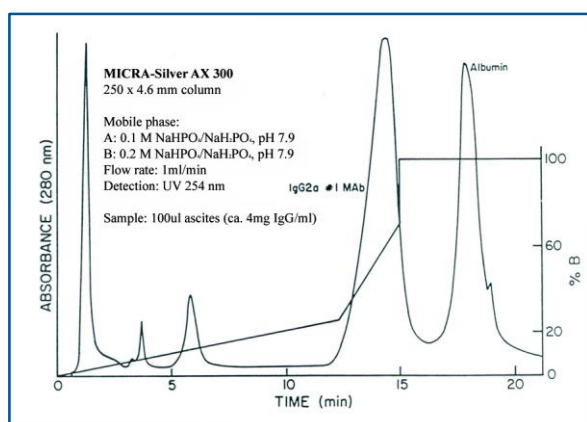
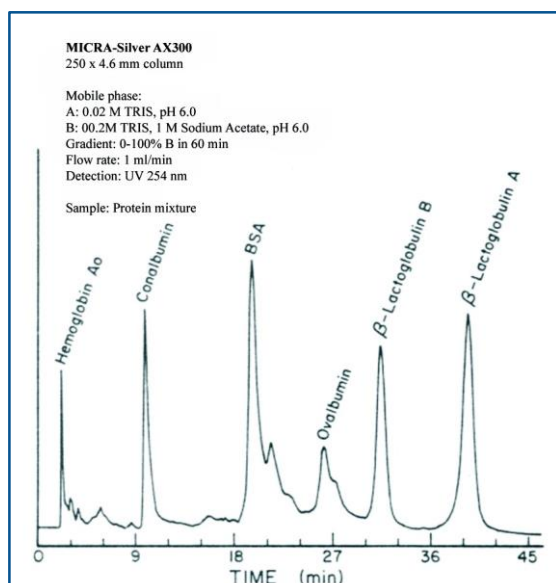

MICRA-Silver Q300

6.5 μ , 300 \AA , Spheroidal silica

This strong anion exchanger is a quaternized, crosslinked polyethyleneimine support. It is compatible with aqueous and many organic solvents in the pH range of 2-8. Ionization of Q300 has no pH dependence. This support is an excellent column for the rapid separation of proteins and enzymes.

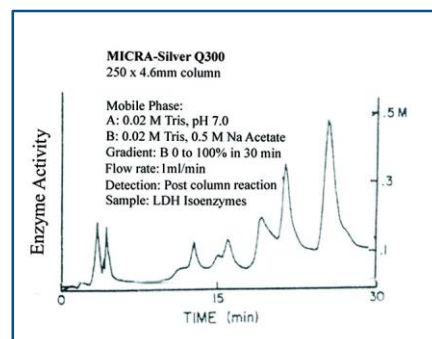
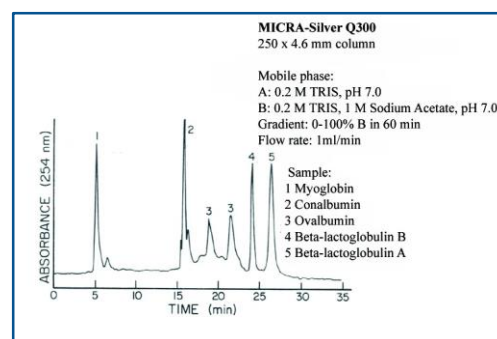

MICRA-Silver Anion Exchange columns offer high resolution and loading capacity as well as excellent recovery of biomolecules. Suggested applications include the analysis, chromatofocusing, carbohydrates, isoenzymes, isoforms of hormone receptor proteins, phosphorylated sugars, immunoglobulins and enzyme assays.

MICRA-Silver Ion Exchange HPLC Columns

MICRA-Silver Cation Exchange HPLC Columns

MICRA-Silver CM300

6.5 μ , 300 \AA , Spheroidal silica

This weak cation exchanger has a polyamide coating containing carboxymethyl groups. It is compatible with aqueous and many organic solvents in the pH range of 2-8. Selectivity can be altered by mobile phase salt composition and pH which affects ionization of both the support and the solute. CM300 permits analysis of proteins up to MWs of 200,000 Da and offers excellent recoveries as well as high loading capacity.

MICRA-Silver S300

6.5 μ , 300 \AA , Spheroidal silica

This strong cation exchanger has a polyamide coating containing sulfopropyl functional groups. It is compatible with aqueous and many organic solvents in the pH range of 2-8. Ionization of the functional groups on this bonded phase is constant above pH 3. S300 is a good choice for separations of basic proteins.

CM (WCX) Specifications for Solute Interaction			
Pore Size	MW	Surface Area	Loading Capacity
300 \AA	<200,000 Da	100 m ² /gm	65 mg Hemoglobin per gm support

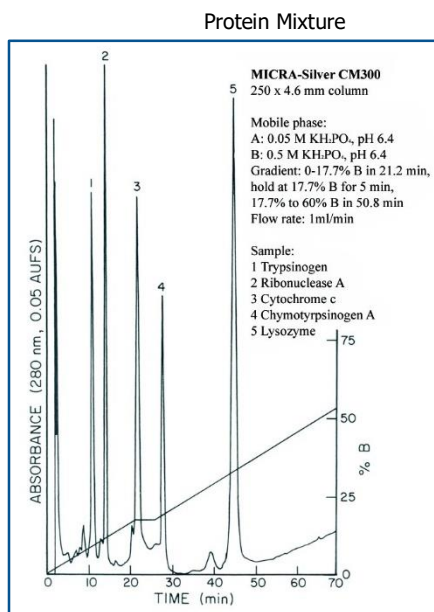

MICRA-Silver Cation Exchange columns offer high resolution and loading capacity as well as excellent recovery of biomolecules. Suggested applications include the analysis of enzymes, proteins, catecholamines, peptides, hemoglobin variants, glycosylated hemoglobins, and crystallins.

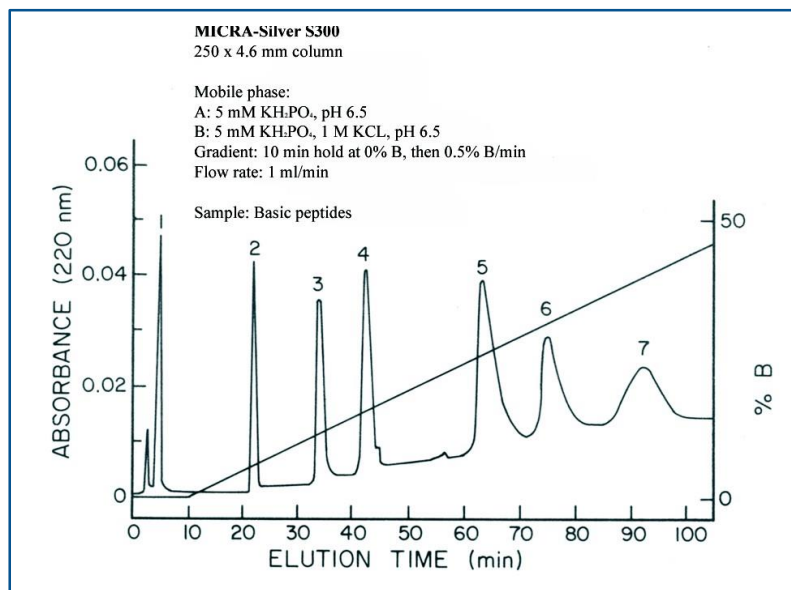
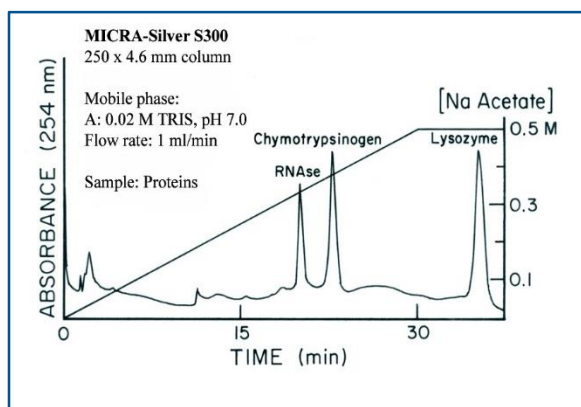
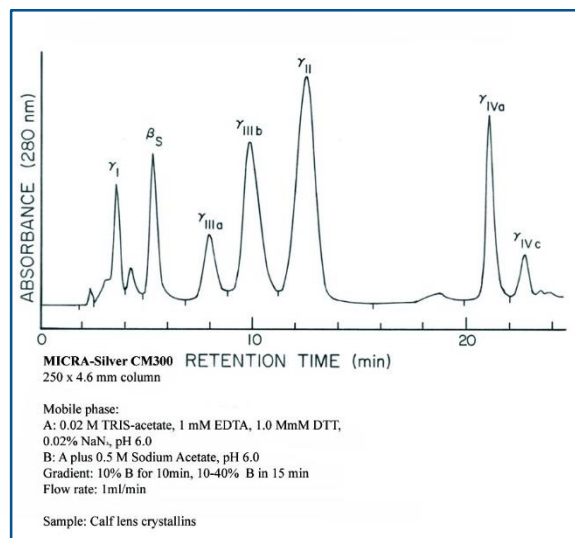

ORDERING INFORMATION: P-630-963-1481; F-630-963-6432; info@eprogen.com

MICRA-Silver Cation Exchange HPLC Columns		CM300	S300
		300Å, 6.5µ	300Å, 6.5µ
	<u>Format (mm)</u>	<u>Item Number</u>	<u>Item Number</u>
Narrow-bore	100x2.1	MB2CCM103-10	MB2CS103-10
	250x2.1	MB2CCM103-25	MB2CS103-25
Narrow-bore Guard	50x2.1	MB2FCCM103-5	MB2FCS103-5
Standard	100x4.6	CCM103-10	CS103-10
	250x4.6	CCM103-25	CS103-25
Standard Guard	33x4.6	FCCM103-3	FCS103-3
	53x4.6	FCCM103-5	FCS103-5
Semi-Prep	250x7.8	SPCCM103-25	SPCS103-25
	250x10	PCCM103-25	PCS103-25
Semi-Prep Guard	50x7.8	SPFCCM103-5	SPFCS103-5
	50x10	PFCCM103-5	PFCS103-5

ORDERING INFORMATION: P-630-963-1481; F-630-963-6432; info@eprogen.com

ORDERING INFORMATION: P-630-963-1481; F-630-963-6432; info@eprogen.com

MICRA-Silver Anion Exchange HPLC Columns		AX300	Q300
		300Å, 6.5µ	300Å, 6.5µ
	<u>Format (mm)</u>	<u>Item Number</u>	<u>Item Number</u>
Narrow-bore	100x2.1	MB2CA103-10	MB2CQ103-10
	250x2.1	MB2CA103-25	MB2CQ103-25
Narrow-bore Guard	50x2.1	MB2FCA103-5	MB2FCQ103-5
Standard	100x4.6	CA103-10	CQ103-10
	250x4.6	CA103-25	CQ103-25
Standard Guard	33x4.6	FCA103-3	FCQ103-3
	53x4.6	FCA103-5	FCQ103-5
Semi-Prep	250x7.8	SPCA103-25	SPCQ103-25
	250x10	PCA103-25	PCQ103-25
Semi-Prep Guard	50x7.8	SPFCA103-5	SPFCQ103-5
	50x10	PFCA103-5	PFCQ103-5

ORDERING INFORMATION: P-630-963-1481; F-630-963-6432; info@eprogen.com

Technical Information Section

Column Use Guidelines

Upon receipt of your HPLC column:

- Examine the label for part number, format, and phase verification.
- Examine the box as well as the column for any signs of physical damage that may have occurred during shipping.
- Each column is tested prior to packaging and is shipped with a QC performance chromatogram (C of A).

Eprogen guarantees the performance of its HPLC columns. To ensure quality, all Eprogen HPLC columns are individually tested and shipped with a copy of the specific QC performance chromatogram, along with a usage protocol sheet. All columns are labeled with the column name, format, catalog number, and unique serial number identifier.

Columns in sealed boxes can be returned by obtaining a return authorization number from Eprogen's customer service, and will be assessed a 15% restocking fee. Columns in unsealed boxes cannot be returned, unless they are defective. An authorization is needed prior to a defective product exchange.

Column Storage Considerations

<u>Phase</u>	<u>Storage Solvent</u>
(Porous Silica)	
Reversed Phase (SCD, RP4, RP8)	>20% Alcohol or Acetonitrile
Ion Exchange (AX, CM, S, Q)	>10% Alcohol
Size Exclusion (GPC) (CATSEC)	>10% Methanol >10% Methanol
<i>NPS</i> (Non-Porous Silica)	
Reversed Phase (ODS-I, ODS-II, ODS-IIIE)	>20% organic (pH≤7)
Normal Phase (Sil)	-100% organic
Specialty Phase (TAS)	>20% organic (pH≤7)

Using correct column storage conditions can increase column lifetime.

Never store columns with buffers or ion pair reagents. Always flush with 5-10 column volumes of mobile phase without buffers to completely remove remaining buffers or salts.

Stationary Phase Information

(Please reference page 15 for guidelines specific to columns packed with ***NPS*** non-porous silica.)

pH issues

Silica-based HPLC columns are sensitive to pH. Mobile phase pH should be maintained between 2.0 and 8.0 for porous supports, and between 1.0 and 9.0 on non-porous supports. Low pH (<1.0) can lead to hydrolysis of the bonded groups resulting in loss of phase. High pH (>9.0) can dissolve the silica forming voids and fines. For conditions requiring lower or higher mobile phase pH's, a pre-saturator column should be installed between the pump and the injector to minimize effects on the stationary phase.

Technical Information Section

Back Pressure Issues

To minimize column and conventional HPLC instrument damage, porous columns should not be run in a continuous fashion at pressures higher than 4000psi. Pressures over 5000psi can result in damage. Columns with large pore sizes should be used at even lower pressures to prevent damage to the packing material. In contrast, the non-porous silica columns routinely operate at approximately 3500psi. These columns easily tolerate higher pressures, however, pressures over 6000psi can affect the separation and hardware of the instrument. For both types of silica, avoid any sudden pressure fluctuations. If back pressures increase, flush the column by reversing the flow. Add a precolumn filter and a guard between the injector and the analytical column. When using an **NPS** column only employ a zero-dead volume precolumn filter, as the use of a guard will greatly increase extra column effects and degrade the separation.

Mobile Phase Guidelines

Use only HPLC-Grade solvents. When changing solvents, insure that the solvents are miscible. Immiscible solvents can damage the stationary phase. Salt or buffer precipitation can also damage the stationary phase. The sample should be soluble in the mobile phase, and whenever possible, the mobile phase should be the sample solvent.

Typical flow rates and load capacities				
I.D. (mm)	Flow Rate (mL/min)	Dynamic Loading (mg protein/25cm length)		
		IEC	RPC	SEC
2	0.2	3	1.5	0.05
4.6	1	15	8	0.2
7.8	2	50	20	2
10	5	80	30	4

Column Cleaning Protocols

Reversed Phase Columns

Columns can be cleaned by washing with repeated gradients of 0.1% TFA in water to 100% ACN. Additional protocol is 30% iPA/1 M NaCl flush for 10-20 column volumes.

Non-Porous Reversed Phase Columns

Columns can be cleaned by reversing the column and washing with repeated gradients of 0.1% TFA in water to 100% ACN. After cleaning, reinstall the column in the correct flow direction (as indicated by the arrow on column) and repeat the procedure.

Ion Exchange Columns

Columns can be cleaned by washing with at least 10 column volumes of 30% iPA/1M NaCl solutions. If the column efficiency has not improved after the above treatment, the column should be further washed at a different pH between 2-8 with an intrinsically stronger salt and/or with 0.1% TFA and then 0.1% TFA and 10% IPA mixture, each for at least 10 column volumes.

Size Exclusion Columns

If components of the sample have become non-specifically adsorbed to the column, it can be cleaned with solvents that would remove them. Detergents, chaotropes, organic solvents or 0.1% TFA can be used.